

PNP Silicon Darlington Transistors

BCV 26
BCV 46

- For general AF applications
- High collector current
- High current gain
- Complementary types: BCV 27, BCV 47 (NPN)

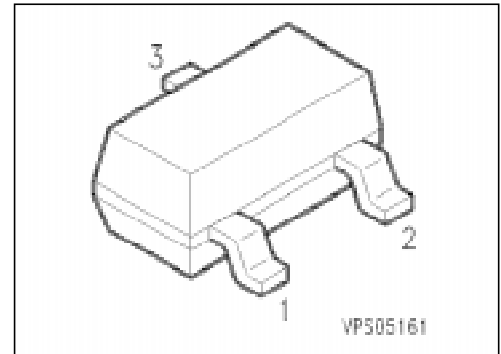

Type	Marking	Ordering Code (tape and reel)	Pin Configuration			Package ¹⁾
			1	2	3	
BCV 26	FDs	Q62702-C1493	B	E	C	SOT-23
BCV 46	FEs	Q62702-C1475				

Maximum Ratings

Parameter	Symbol	Values		Unit
		BCV 26	BCV 46	
Collector-emitter voltage	V_{CE0}	30	60	V
Collector-base voltage	V_{CB0}	40	80	
Emitter-base voltage	V_{EB0}	10	10	
Collector current	I_C	500		mA
Peak collector current	I_{CM}	800		
Base current	I_B	100		
Peak base current	I_{BM}	200		
Total power dissipation, $T_s = 74\text{ °C}$	P_{tot}	360		mW
Junction temperature	T_j	150		°C
Storage temperature range	T_{stg}	- 65 ... + 150		

Thermal Resistance

Junction - ambient ²⁾	$R_{th\ JA}$	≤ 280	K/W
Junction - soldering point	$R_{th\ JS}$	≤ 210	

1) For detailed information see chapter Package Outlines.

2) Package mounted on epoxy pcb 40 mm × 40 mm × 1.5 mm/6 cm² Cu.

Electrical Characteristics

at $T_A = 25\text{ °C}$, unless otherwise specified.

Parameter	Symbol	Values			Unit
		min.	typ.	max.	

DC characteristics

Collector-emitter breakdown voltage $I_C = 10\text{ mA}$	$V_{(BR)CE0}$				V
BCV 26		30	—	—	
BCV 46		60	—	—	
Collector-base breakdown voltage $I_C = 100\text{ }\mu\text{A}$	$V_{(BR)CB0}$				
BCV 26		40	—	—	
BCV 46		80	—	—	
Emitter-base breakdown voltage, $I_E = 10\text{ }\mu\text{A}$	$V_{(BR)EB0}$	10	—	—	
Collector cutoff current $V_{CB} = 30\text{ V}$	I_{CB0}				nA
BCV 26		—	—	100	
$V_{CB} = 60\text{ V}$					nA
BCV 46		—	—	100	
$V_{CB} = 30\text{ V}, T_A = 150\text{ °C}$					μA
BCV 26		—	—	10	
$V_{CB} = 60\text{ V}, T_A = 150\text{ °C}$					μA
BCV 46		—	—	10	
Emitter cutoff current, $V_{EB} = 4\text{ V}$	I_{EB0}	—	—	100	nA
DC current gain ¹⁾ $I_C = 100\text{ }\mu\text{A}, V_{CE} = 1\text{ V}$	h_{FE}				—
BCV 26		4000	—	—	
BCV 46		2000	—	—	
$I_C = 10\text{ mA}, V_{CE} = 5\text{ V}$					
BCV 26		10000	—	—	
BCV 46		4000	—	—	
$I_C = 100\text{ mA}, V_{CE} = 5\text{ V}$					
BCV 26		20000	—	—	
BCV 46		10000	—	—	
$I_C = 0.5\text{ A}, V_{CE} = 5\text{ V}$					
BCV 26		4000	—	—	
BCV 46		2000	—	—	
Collector-emitter saturation voltage ¹⁾ $I_C = 100\text{ mA}, I_B = 0.1\text{ mA}$	V_{CEsat}	—	—	1	V
Base-emitter saturation voltage ¹⁾ $I_C = 100\text{ mA}, I_B = 0.1\text{ mA}$	V_{BEsat}	—	—	1.5	

AC characteristics

Transition frequency $I_C = 50\text{ mA}, V_{CE} = 5\text{ V}, f = 20\text{ MHz}$	f	—	200	—	MHz
Output capacitance $V_{CB} = 10\text{ V}, f = 1\text{ MHz}$	C_{obo}	—	4.5	—	pF

¹⁾ Pulse test: $t \leq 300\text{ }\mu\text{s}, D = 2\%$.

Total power dissipation $P_{tot} = f(T_A^*; T_S)$

* Package mounted on epoxy

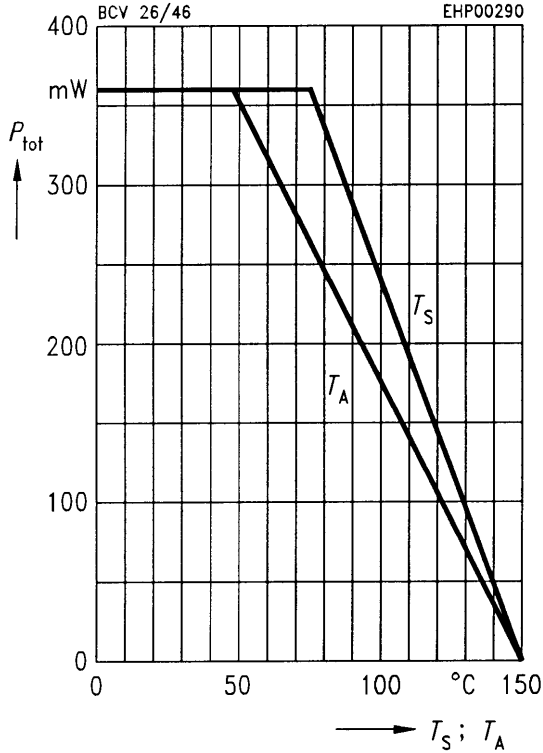

Collector-base capacitance $C_{CB0} = f(V_{CB0})$

Emitter-base capacitance $C_{EB0} = f(V_{EB0})$

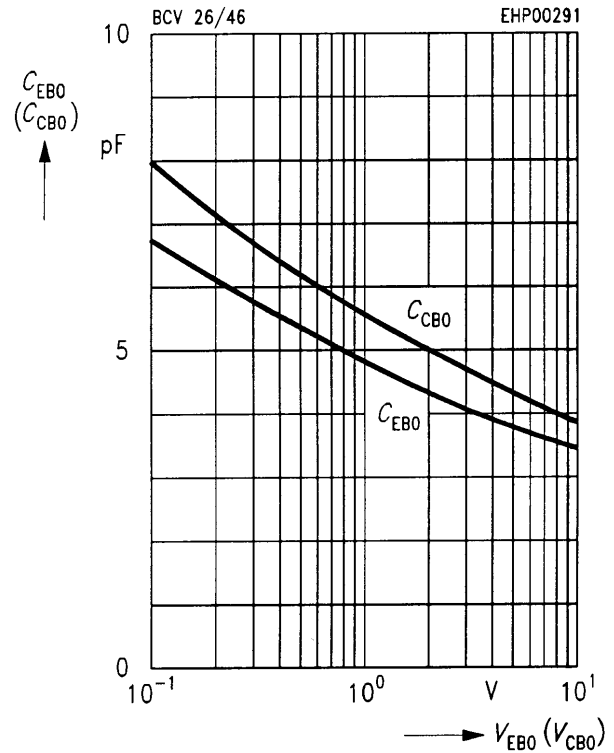

Permissible pulse load $P_{tot max}/P_{tot DC} = f(t_p)$

Transition frequency $f_T = f(I_C)$

$V_{CE} = 5 V$

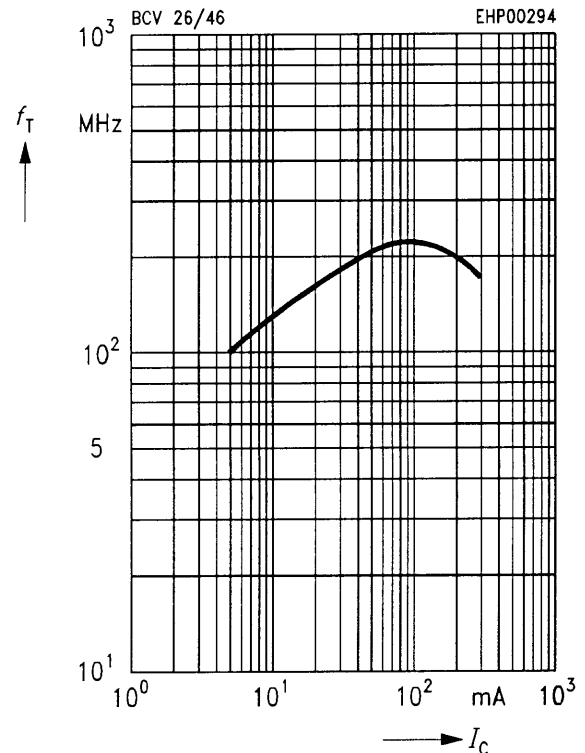
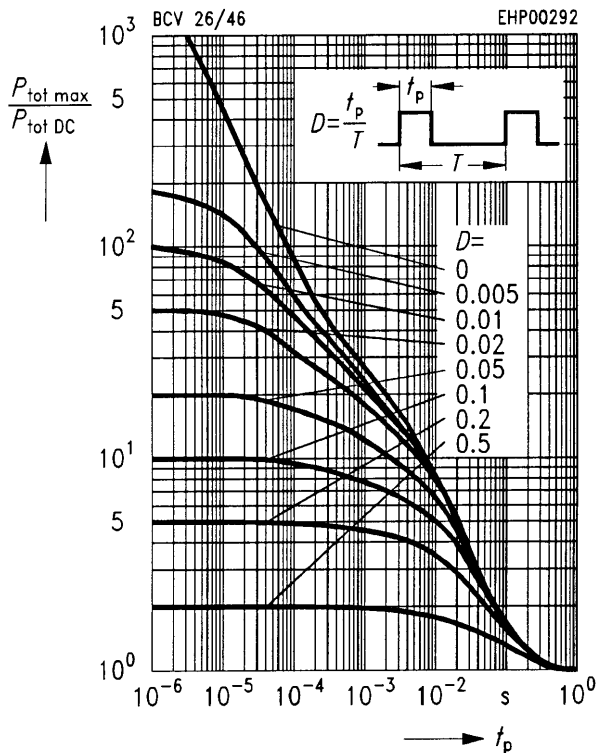

Base-emitter saturation voltage

$I_C = f(V_{BEsat})$
 $h_{FE} = 1000$

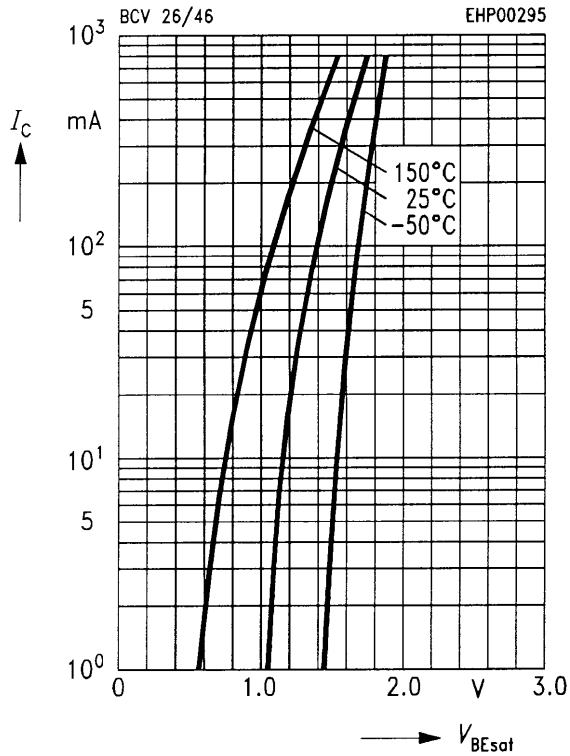

Collector-emitter saturation voltage

$I_C = f(V_{CEsat})$
 $h_{FE} = 1000$

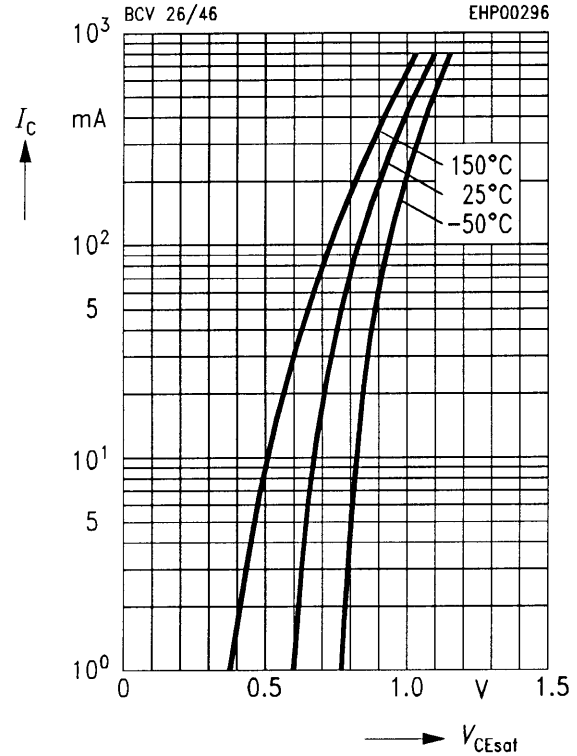

Collector cutoff current $I_{CB0} = f(T_A)$

$V_{CB} = V_{CE max}$

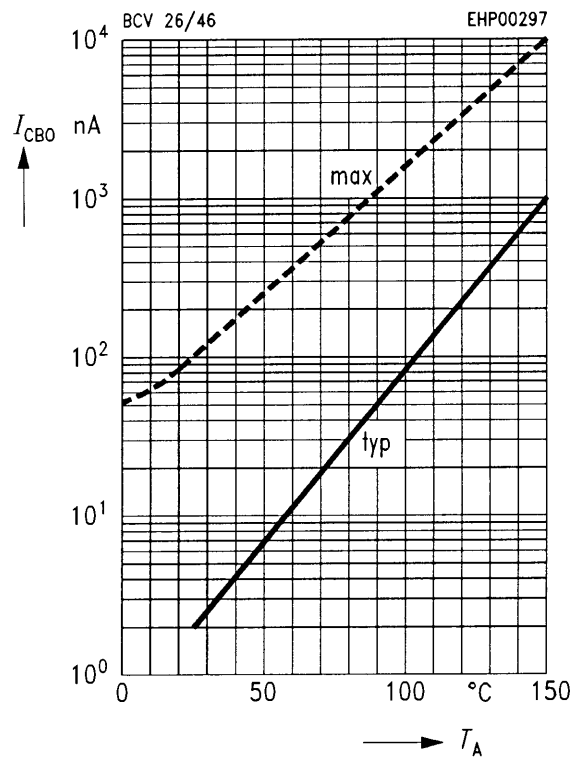

DC current gain $h_{FE} = f(I_C)$

$V_{CE} = 5 V$

