

LM341/LM78MXX Series 3-Terminal Positive Voltage Regulators

General Description

The LM341 and LM78MXX series of three-terminal positive voltage regulators employ built-in current limiting, thermal shutdown, and safe-operating area protection which makes them virtually immune to damage from output overloads.

With adequate heatsinking, they can deliver in excess of 0.5A output current. Typical applications would include local (on-card) regulators which can eliminate the noise and degraded performance associated with single-point regulation.

Features

- Output current in excess of 0.5A
- No external components
- Internal thermal overload protection
- Internal short circuit current-limiting
- Output transistor safe-area compensation
- Available in TO-220, TO-39, and TO-252 D-PAK packages
- Output voltages of 5V, 12V, and 15V

Connection Diagrams

TO-39 Metal Can Package (H)

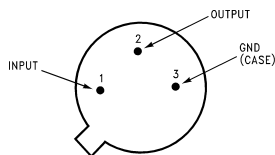

DS010484-5

Bottom View

Order Number LM78M05CH, LM78M12CH or LM78M15CH
See NS Package Number H03A

TO-220 Power Package (T)

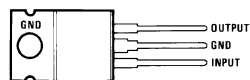

DS010484-6

Top View

Order Number LM341T-5.0, LM341T-12, LM341T-15, LM78M05CT, LM78M12CT or LM78M15CT
See NS Package Number T03B

TO-252

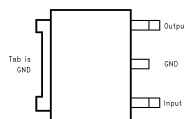

DS010484-19

Top View

Order Number LM78M05CDT
See NS Package Number TD03B

Absolute Maximum Ratings (Note 1)

If Military/Aerospace specified devices are required, please contact the National Semiconductor Sales Office/Distributors for availability and specifications.

Lead Temperature (Soldering, 10 seconds)	
TO-39 Package (H)	300°C
TO-220 Package (T)	260°C

Storage Temperature Range	-65°C to +150°C
Operating Junction Temperature Range	-40°C to +125°C
Power Dissipation (Note 2)	Internally Limited
Input Voltage	
5V ≤ V _O ≤ 15V	35V
ESD Susceptibility	TBD

Electrical Characteristics

Limits in standard typeface are for T_J = 25°C, and limits in **boldface type** apply over the -40°C to +125°C operating temperature range. Limits are guaranteed by production testing or correlation techniques using standard Statistical Quality Control (SQC) methods.

LM341-5.0, LM78M05C

Unless otherwise specified: V_{IN} = 10V, C_{IN} = 0.33 μF, C_O = 0.1 μF

Symbol	Parameter	Conditions	Min	Typ	Max	Units
V _O	Output Voltage	I _L = 500 mA	4.8	5.0	5.2	V
		5 mA ≤ I _L ≤ 500 mA P _D ≤ 7.5W, 7.5V ≤ V _{IN} ≤ 20V	4.75	5.0	5.25	
V _{R LINE}	Line Regulation	7.2V ≤ V _{IN} ≤ 25V	I _L = 100 mA		50	mV
			I _L = 500 mA		100	
V _{R LOAD}	Load Regulation	5 mA ≤ I _L ≤ 500 mA			100	
I _Q	Quiescent Current	I _L = 500 mA		4	10.0	mA
ΔI _Q	Quiescent Current Change	5 mA ≤ I _L ≤ 500 mA			0.5	
		7.5V ≤ V _{IN} ≤ 25V, I _L = 500 mA			1.0	
V _n	Output Noise Voltage	f = 10 Hz to 100 kHz		40		μV
$\frac{\Delta V_{IN}}{\Delta V_O}$	Ripple Rejection	f = 120 Hz, I _L = 500 mA		78		dB
V _{IN}	Input Voltage Required to Maintain Line Regulation	I _L = 500 mA	7.2			V
ΔV _O	Long Term Stability	I _L = 500 mA			20	mV/khrs

Electrical Characteristics

Limits in standard typeface are for $T_J = 25^\circ\text{C}$, and limits in **boldface type** apply over the -40°C to $+125^\circ\text{C}$ operating temperature range. Limits are guaranteed by production testing or correlation techniques using standard Statistical Quality Control (SQC) methods. (Continued)

LM341-12, LM78M12C

Unless otherwise specified: $V_{IN} = 19\text{V}$, $C_{IN} = 0.33\ \mu\text{F}$, $C_O = 0.1\ \mu\text{F}$

Symbol	Parameter	Conditions	Min	Typ	Max	Units
V_O	Output Voltage	$I_L = 500\ \text{mA}$	11.5	12	12.5	V
		$5\ \text{mA} \leq I_L \leq 500\ \text{mA}$	11.4	12	12.6	
		$P_D \leq 7.5\text{W}$, $14.8\text{V} \leq V_{IN} \leq 27\text{V}$				
$V_{R\ \text{LINE}}$	Line Regulation	$14.5\text{V} \leq V_{IN} \leq 30\text{V}$			120	mV
		$I_L = 100\ \text{mA}$			240	
$V_{R\ \text{LOAD}}$	Load Regulation	$5\ \text{mA} \leq I_L \leq 500\ \text{mA}$			240	
I_Q	Quiescent Current	$I_L = 500\ \text{mA}$		4	10.0	mA
ΔI_Q	Quiescent Current Change	$5\ \text{mA} \leq I_L \leq 500\ \text{mA}$			0.5	
		$14.8\text{V} \leq V_{IN} \leq 30\text{V}$, $I_L = 500\ \text{mA}$			1.0	
V_n	Output Noise Voltage	$f = 10\ \text{Hz to } 100\ \text{kHz}$		75		μV
$\frac{\Delta V_{IN}}{\Delta V_O}$	Ripple Rejection	$f = 120\ \text{Hz}$, $I_L = 500\ \text{mA}$		71		dB
V_{IN}	Input Voltage Required to Maintain Line Regulation	$I_L = 500\ \text{mA}$	14.5			V
ΔV_O	Long Term Stability	$I_L = 500\ \text{mA}$			48	mV/khrs

LM341-15, LM78M15C

Unless otherwise specified: $V_{IN} = 23\text{V}$, $C_{IN} = 0.33\ \mu\text{F}$, $C_O = 0.1\ \mu\text{F}$

Symbol	Parameter	Conditions	Min	Typ	Max	Units
V_O	Output Voltage	$I_L = 500\ \text{mA}$	14.4	15	15.6	V
		$5\ \text{mA} \leq I_L \leq 500\ \text{mA}$	14.25	15	15.75	
		$P_D \leq 7.5\text{W}$, $18\text{V} \leq V_{IN} \leq 30\text{V}$				
$V_{R\ \text{LINE}}$	Line Regulation	$17.6\text{V} \leq V_{IN} \leq 30\text{V}$			150	mV
		$I_L = 100\ \text{mA}$			300	
$V_{R\ \text{LOAD}}$	Load Regulation	$5\ \text{mA} \leq I_L \leq 500\ \text{mA}$			300	
I_Q	Quiescent Current	$I_L = 500\ \text{mA}$		4	10.0	mA
ΔI_Q	Quiescent Current Change	$5\ \text{mA} \leq I_L \leq 500\ \text{mA}$			0.5	
		$18\text{V} \leq V_{IN} \leq 30\text{V}$, $I_L = 500\ \text{mA}$			1.0	
V_n	Output Noise Voltage	$f = 10\ \text{Hz to } 100\ \text{kHz}$		90		μV
$\frac{\Delta V_{IN}}{\Delta V_O}$	Ripple Rejection	$f = 120\ \text{Hz}$, $I_L = 500\ \text{mA}$		69		dB
V_{IN}	Input Voltage Required to Maintain Line Regulation	$I_L = 500\ \text{mA}$	17.6			V
ΔV_O	Long Term Stability	$I_L = 500\ \text{mA}$			60	mV/khrs

Note 1: Absolute maximum ratings indicate limits beyond which damage to the component may occur. Electrical specifications do not apply when operating the device outside of its rated operating conditions.

Note 2: The typical thermal resistance of the three package types is:

T (TO-220) package: $\theta_{(JA)} = 60\ ^\circ\text{C/W}$, $\theta_{(JC)} = 5\ ^\circ\text{C/W}$

H (TO-39) package: $\theta_{(JA)} = 120\ ^\circ\text{C/W}$, $\theta_{(JC)} = 18\ ^\circ\text{C/W}$

DT (TO-252) package: $\theta_{(JA)} = 92\ ^\circ\text{C/W}$, $\theta_{(JC)} = 10\ ^\circ\text{C/W}$

Schematic Diagram

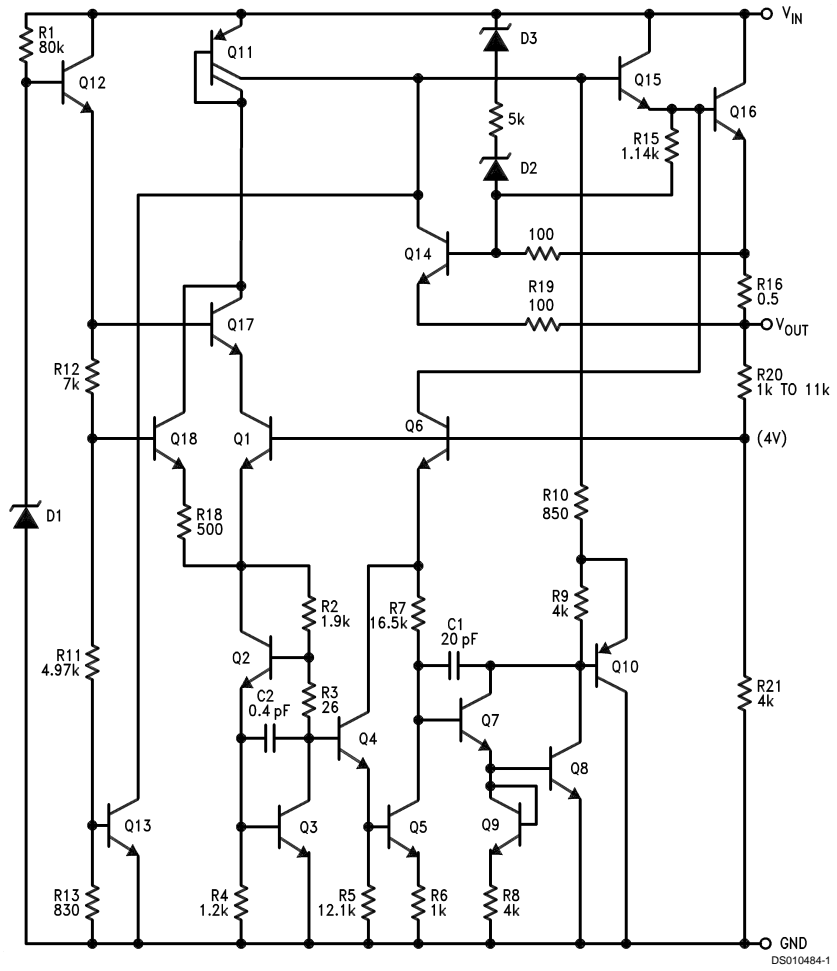

DS010484-1

Typical Performance Characteristics

Peak Output Current

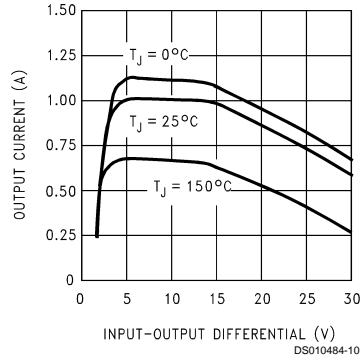

Ripple Rejection

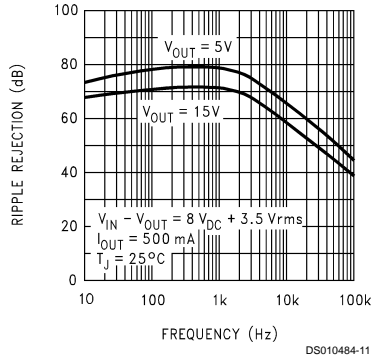

Ripple Rejection

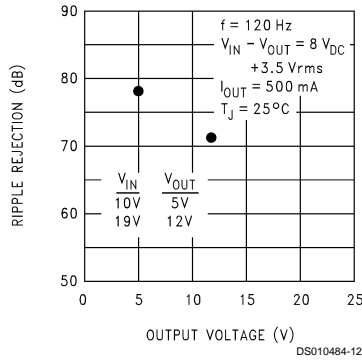

Dropout Voltage

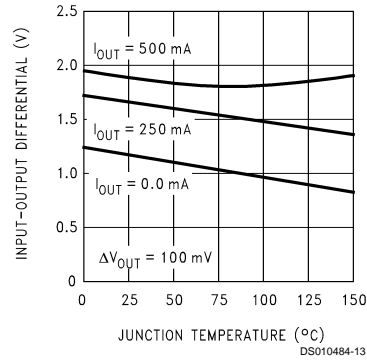

Output Voltage (Normalized to 1V at $T_J = 25^\circ\text{C}$)

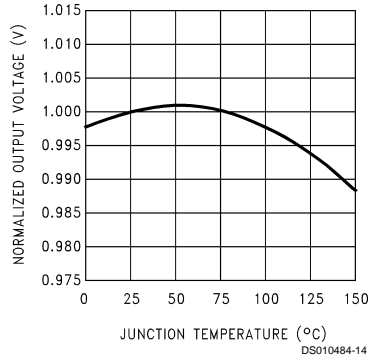

Quiescent Current

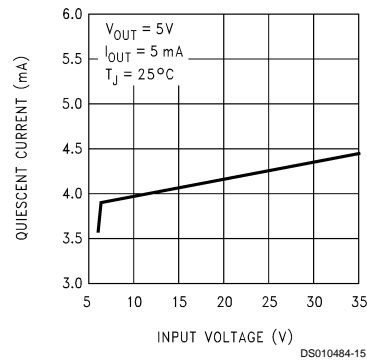

Typical Performance Characteristics (Continued)

Quiescent Current

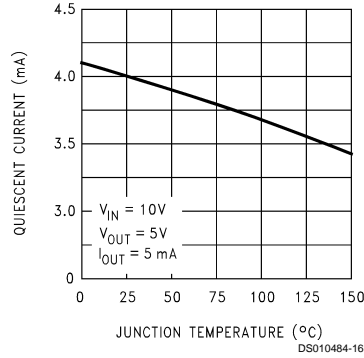

Output Impedance

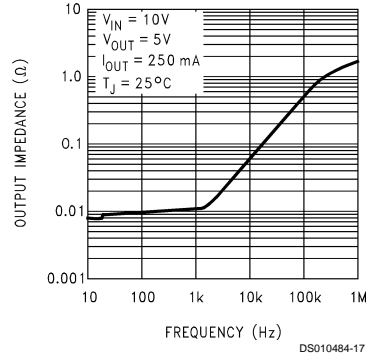

Line Transient Response

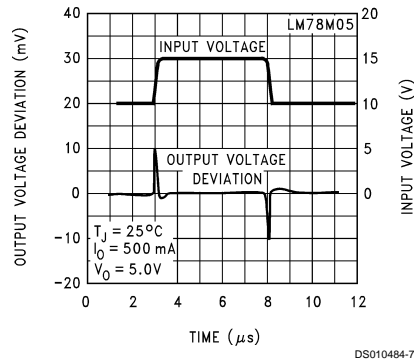

Load Transient Response

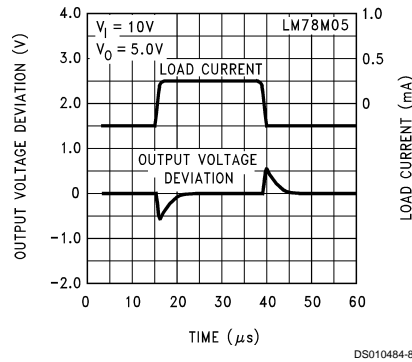

Design Considerations

The LM78MXX/LM341XX fixed voltage regulator series has built-in thermal overload protection which prevents the device from being damaged due to excessive junction temperature.

The regulators also contain internal short-circuit protection which limits the maximum output current, and safe-area protection for the pass transistor which reduces the short-circuit current as the voltage across the pass transistor is increased.

Although the internal power dissipation is automatically limited, the maximum junction temperature of the device must be kept below +125°C in order to meet data sheet specifications. An adequate heatsink should be provided to assure this limit is not exceeded under worst-case operating conditions (maximum input voltage and load current) if reliable performance is to be obtained).

1.0 Heatsink Considerations

When an integrated circuit operates with appreciable current, its junction temperature is elevated. It is important to quantify its thermal limits in order to achieve acceptable performance and reliability. This limit is determined by summing the individual parts consisting of a series of temperature rises from the semiconductor junction to the operating environment. A one-dimension steady-state model of conduction heat transfer is demonstrated in The heat generated at the

device junction flows through the die to the die attach pad, through the lead frame to the surrounding case material, to the printed circuit board, and eventually to the ambient environment. Below is a list of variables that may affect the thermal resistance and in turn the need for a heatsink.

$R^{θ}_{JC}$ (Component Variables) $R^{θ}_{CA}$ (Application Variables)

Leadframe Size & Material	Mounting Pad Size, Material, & Location
No. of Conduction Pins	Placement of Mounting Pad
Die Size	PCB Size & Material
Die Attach Material	Traces Length & Width
Molding Compound Size and Material	Adjacent Heat Sources
	Volume of Air
	Air Flow
	Ambient Temperature
	Shape of Mounting Pad

Design Considerations (Continued)

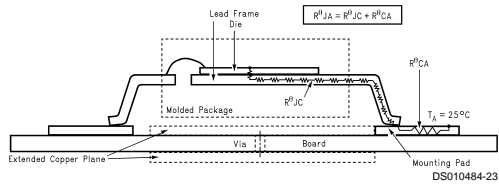

FIGURE 1. Cross-sectional view of Integrated Circuit Mounted on a printed circuit board. Note that the case temperature is measured at the point where the leads contact with the mounting pad surface

The LM78MXX/LM341XX regulators have internal thermal shutdown to protect the device from over-heating. Under all possible operating conditions, the junction temperature of the LM78MXX/LM341XX must be within the range of 0°C to 125°C. A heatsink may be required depending on the maximum power dissipation and maximum ambient temperature of the application. To determine if a heatsink is needed, the power dissipated by the regulator, P_D , must be calculated:

$$I_{IN} = I_L + I_G$$

$$P_D = (V_{IN} - V_{OUT}) I_L + V_{IN} I_G$$

shows the voltages and currents which are present in the circuit.

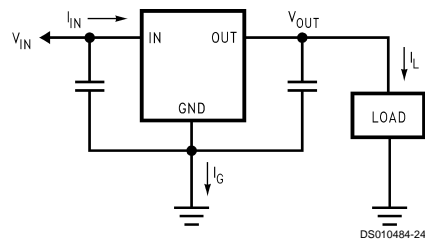

FIGURE 2. Power Dissipation Diagram

The next parameter which must be calculated is the maximum allowable temperature rise, $T_R(\max)$:

$$\theta_{JA} = T_R(\max) / P_D$$

If the maximum allowable value for θ_{JA} °C/w is found to be ≥ 60 °C/W for TO-220 package or ≥ 92 °C/W for TO-252 package, no heatsink is needed since the package alone will dissipate enough heat to satisfy these requirements. If the calculated value for θ_{JA} fall below these limits, a heatsink is required.

As a design aid, *Table 1* shows the value of the θ_{JA} of TO-252 for different heatsink area. The copper patterns that we used to measure these θ_{JA} are shown at the end of the Application Note Section. reflects the same test results as what are in the *Table 1*

shows the maximum allowable power dissipation vs. ambient temperature for the TO-252 device. shows the maximum allowable power dissipation vs. copper area (in²) for the TO-252 device. Please see AN1028 for power enhancement techniques to be used with TO-252 package.

TABLE 1. θ_{JA} Different Heatsink Area

Layout	Copper Area		Thermal Resistance (θ_{JA} , °C/W) TO-252
	Top Side (in ²)*	Bottom Side (in ²)	
1	0.0123	0	103
2	0.066	0	87
3	0.3	0	60
4	0.53	0	54
5	0.76	0	52
6	1	0	47
7	0	0.2	84
8	0	0.4	70
9	0	0.6	63
10	0	0.8	57
11	0	1	57
12	0.066	0.066	89
13	0.175	0.175	72
14	0.284	0.284	61
15	0.392	0.392	55
16	0.5	0.5	53

*Tab of device attached to topside copper

Design Considerations (Continued)

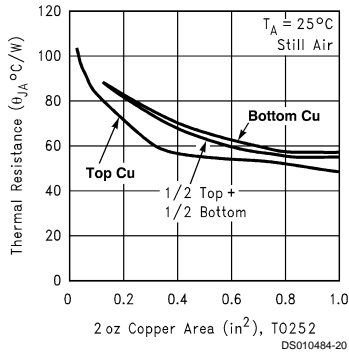

FIGURE 3. θ_{JA} vs. 2oz Copper Area for TO-252

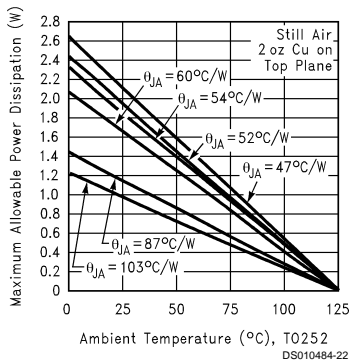

FIGURE 4. Maximum Allowable Power Dissipation vs. Ambient Temperature for TO-252

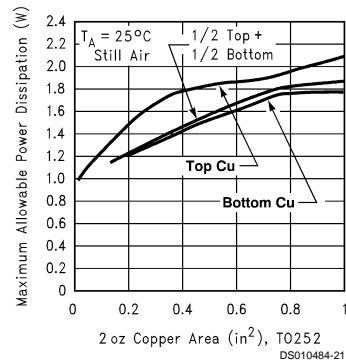
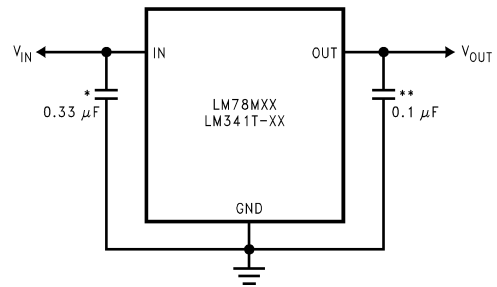

FIGURE 5. Maximum Allowable Power Dissipation vs. 2oz. Copper Area for TO-252

Typical Application



*Required if regulator input is more than 4 inches from input filter capacitor (or if no input filter capacitor is used).
 **Optional for improved transient response.

Physical Dimensions inches (millimeters) unless otherwise noted

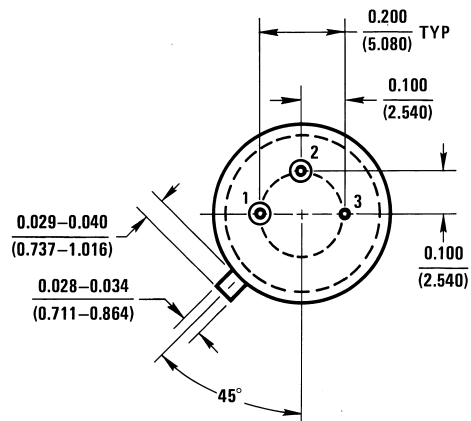
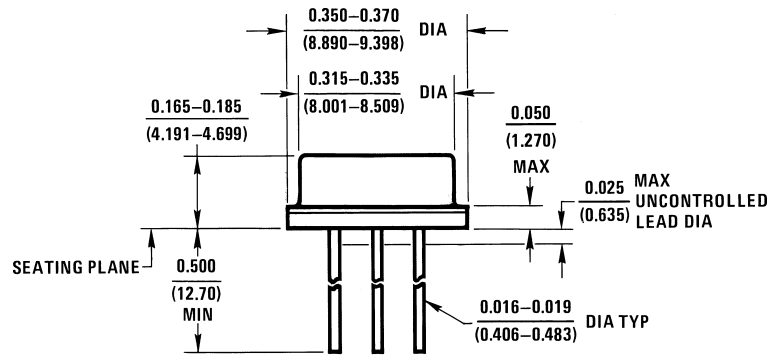

H03A (REV B)

TO-39 Metal Can Package (H)
Order Number LM78M05CH, LM78M12CH or LM78M15CH
NS Package Number H03A

Physical Dimensions inches (millimeters) unless otherwise noted (Continued)

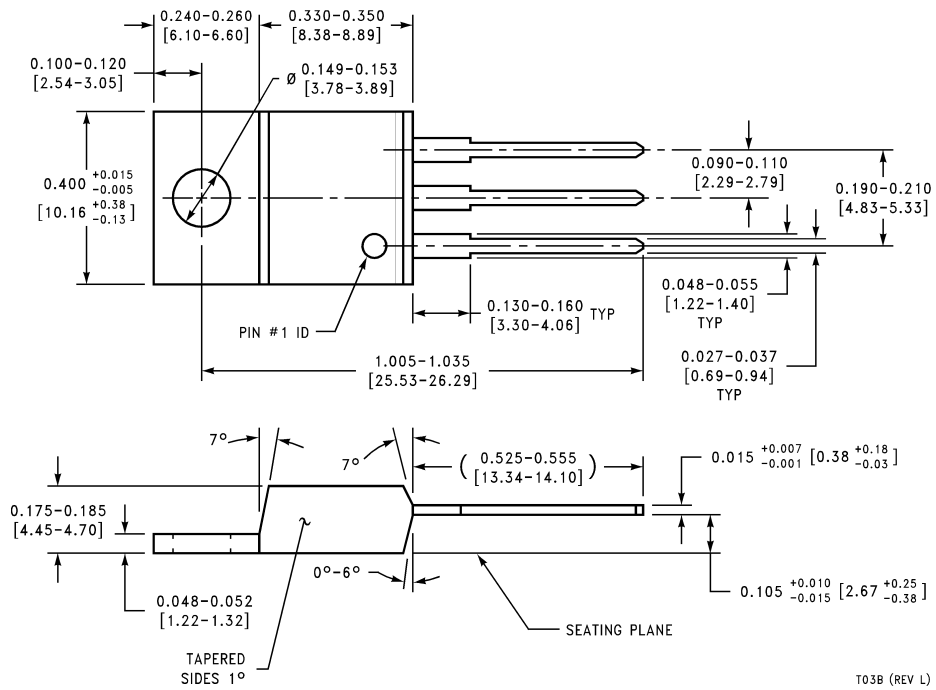

TO-220 Power Package (T)
Order Number LM341T-5.0, LM341T-12, LM341T-15, LM78M05CT, LM78M12CT or LM78M15CT
NS Package Number T03B

Physical Dimensions inches (millimeters) unless otherwise noted (Continued)

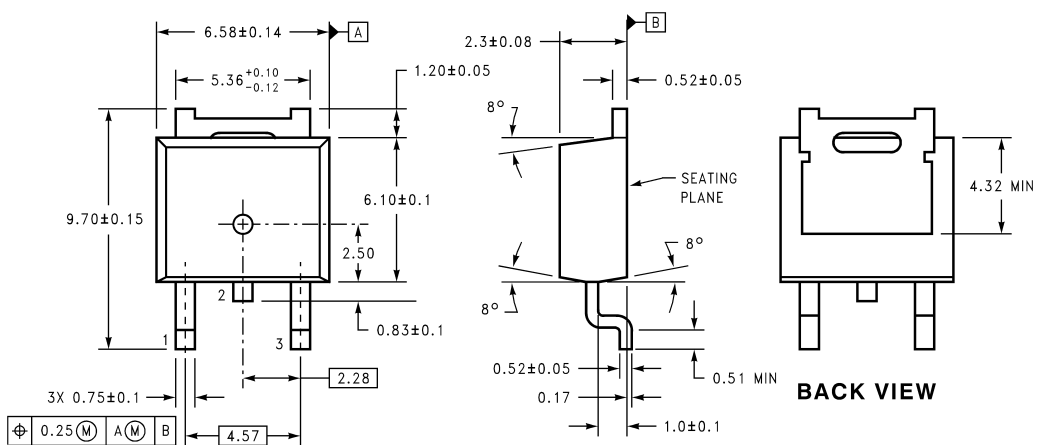

DIMENSIONS ARE IN MILLIMETERS
TO-252
Order Number LM78M05CDT
NS Package Number TD03B

TD03B (REV A)

LIFE SUPPORT POLICY

NATIONAL'S PRODUCTS ARE NOT AUTHORIZED FOR USE AS CRITICAL COMPONENTS IN LIFE SUPPORT DEVICES OR SYSTEMS WITHOUT THE EXPRESS WRITTEN APPROVAL OF THE PRESIDENT AND GENERAL COUNSEL OF NATIONAL SEMICONDUCTOR CORPORATION. As used herein:

1. Life support devices or systems are devices or systems which, (a) are intended for surgical implant into the body, or (b) support or sustain life, and whose failure to perform when properly used in accordance with instructions for use provided in the labeling, can be reasonably expected to result in a significant injury to the user.
2. A critical component is any component of a life support device or system whose failure to perform can be reasonably expected to cause the failure of the life support device or system, or to affect its safety or effectiveness.

<p>National Semiconductor Corporation Americas Tel: 1-800-272-9959 Fax: 1-800-737-7018 Email: support@nsc.com www.national.com</p>	<p>National Semiconductor Europe Fax: +49 (0) 1 80-530 85 86 Email: europe.support@nsc.com Deutsch Tel: +49 (0) 1 80-530 85 85 English Tel: +49 (0) 1 80-532 78 32 Français Tel: +49 (0) 1 80-532 93 58 Italiano Tel: +49 (0) 1 80-534 16 80</p>	<p>National Semiconductor Asia Pacific Customer Response Group Tel: 65-2544466 Fax: 65-2504466 Email: sea.support@nsc.com</p>	<p>National Semiconductor Japan Ltd. Tel: 81-3-5639-7560 Fax: 81-3-5639-7507</p>
--	---	---	---

National does not assume any responsibility for use of any circuitry described, no circuit patent licenses are implied and National reserves the right at any time without notice to change said circuitry and specifications.