

# DSMI Electronics SA

CATALOG 2008

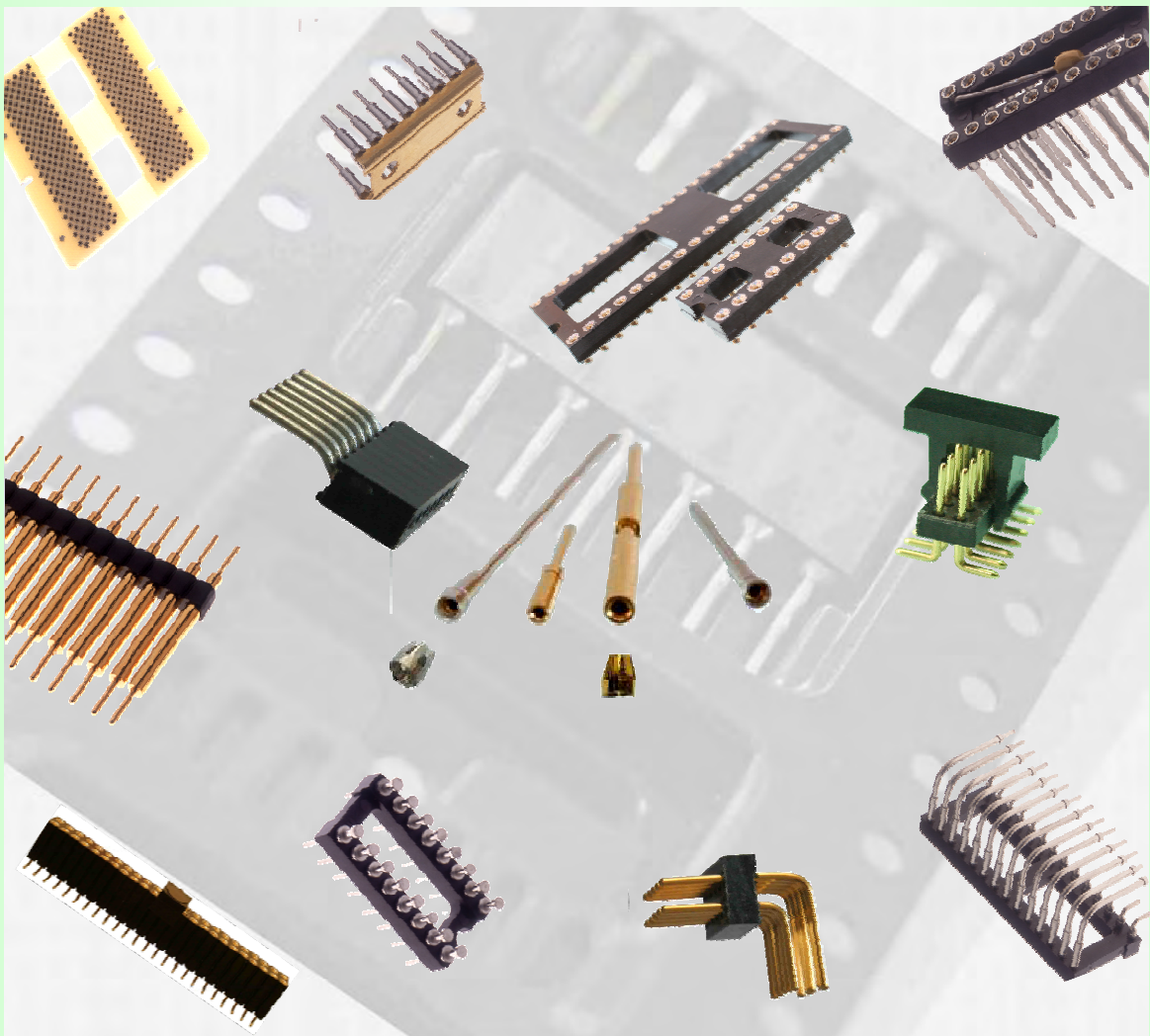

**IC Sockets**

**PCB Connectors**

**Interconnect Components**

## PREFACE

Although founded in 2003, DSMI ELECTRONICS SA inherits more than 29 years of proven experience and ability in the manufacturing of IC Sockets and various assemblies.

Previously known as Electronics SA Isérables and more recently as DSMI Electronics SA Isérables , we are situated at the height of 1000m in the village of Isérables in the Swiss Alps. Our unique location allows DSMI Electronics SA to operate highly efficiently with a loyal, experienced and flexible team.

At DSMI Electronics SA, we listen and respond to our customer's needs. We supply high quality Swiss products to a worldwide customer base who benefits from competitive prices and short lead times.

DSMI Electronics SA's specialities are the following:

- IC Sockets manufacturing
- Development of bespoke products
- Coaxial connectors and cable assembly
- Assembly subcontracting

For our other products or if you need further information, please [contact](#) the Customer Service.

### NOTES:

- The drawings are not to scale
- All dimensions in this catalog are in millimeters
- All right reserved, ©DSMI ELECTRONICS SA Isérables, juin 2003
- DSMI reserves the right to change any information provided in this catalog without notification





## RoHS Directive Products



All our products are available as RoHS compliant and compatible :

- RoHS compliant: With a standard insulator resisting to a soldering heat of 260°C for 5 seconds (economical version).
- RoHS compatible: With a high temperature insulator resisting to 280°C for 10 seconds (or 260°C for 20 sec) according to the JEDEC directive J-STD-020C.





The actual tin plating process is approved. Other platings are available upon request and gold plated contacts can still be ordered.

Our products do not contain any of the other substances banned by the RoHS directive.

Our part numbers have been modified following the needed plating. You will find more details in this catalog.

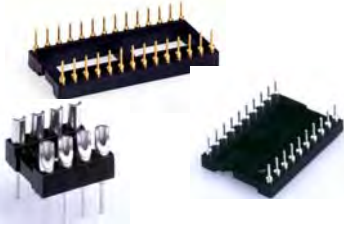

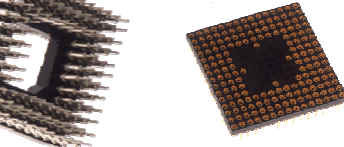
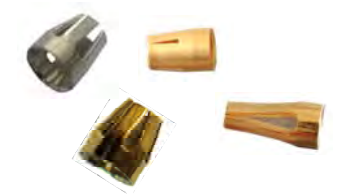

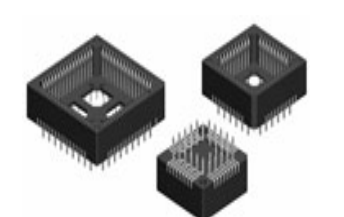





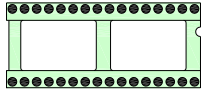

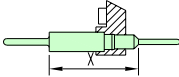
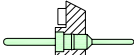
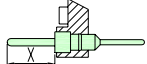
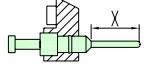

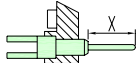
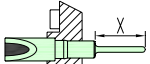
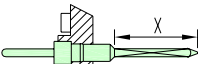
Upon request you can still get non-RoHS items.

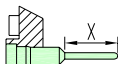
For further information, please contact our Customer Service.

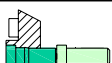
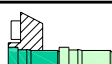
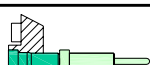
<p><b>DIP</b></p>	 <p>ORDER FORM PAGE 6</p>	<p>Pages 4-5</p>	
<p><b>SIP</b> Mating pin standard 0.47mm</p>	 <p>ORDER FORM PAGE 28</p>	<p>Page 25</p>	<p>Sockets 2.54mm pitch</p>
		<p>Page 26</p>	<p>Headers 2.54mm pitch</p>
		<p>Page 27</p>	<p>1.778mm / 1.8mm / 2mm / 1.27mm / 1mm pitch</p>
<p><b>PCB</b> Mating pin standard 0.76mm</p>	 <p>ORDER FORM PAGE 59</p>	<p>Page 58</p>	
<p><b>PGA / BGA</b></p>	 <p>ORDER FORM 700,701: PAGE 73 703,705: PAGE 77 704,706,707,709: PAGE 81</p>	<p>Page 68</p>	
<p><b>CLIP</b></p>		<p>Page 82</p>	
<p><b>SPRING LOADED</b></p>		<p>Page 83</p>	
<p><b>PLCC</b></p>		<p>Pages 84-85</p>	

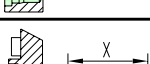

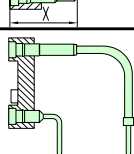





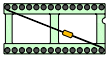
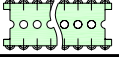

DIP

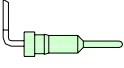
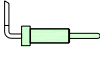
SERIES		610 / 630 / 640 / 650 / 911	102 / 300 / 400
		2.54mm pitch / Mating pin 0.47 / (0.76)	2.54mm pitch / Closed frame
SP			
HEADERS	PB		14-15
	MC		14-15
	TT / TU		14-15
	TC / WT / WU		14-15
	TC.SMV <i>Surface mount</i>		14-15
	FF / JJ / KK		14-15
	XX / LL / MM		14-15
	RR / SS		14-15
SOCKETS	CC		7
	CJ / CM		7
	CN.SWT / CN.SWU <i>Carrier</i>		22
	CC.CKWT <i>Carrier</i>		21
	CC.CCWT <i>Carrier</i>		21
	CC.CK <i>Carrier</i>		21
	CC.CC <i>Carrier</i>		21
	LV		8
	AA / AB / BA / BB		10
	LC		9
	CLR / CLR1		13
	CCPF1 / CCPF2		Upon request

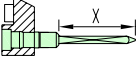
16

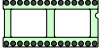
## DIP

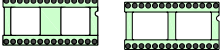
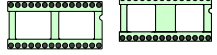
SERIES		619 / 639 / 649	900 / 960
		2.54mm pitch / Integral decoupling capacitor 	2.54mm pitch / Carrier 2.54 
SOCKETS	SP		
	CC		17
	CC Carrier		23
	CK Carrier		23
	CCWT Carrier		23
	CKWT Carrier		23
AB / BB / AA / BA			17

SERIES		6100 / 6300 / 6301	510 / 530 / 540	1102 / 5102 / 3300 / 4400	1112 / 5112 / 3330 / 4440	720 / 721 / 722 / 723 / 7212
		2.54mm pitch Automatic assembly 	2.54mm pitch Solder tail Ultra low profile 	2.54mm pitch SM / Floating mating 	2.54mm pitch SM / Gull wing 	1.78mm pitch 
HEADERS	MC / MCS		12			
	ML / PML				20	
	TUST / PTUST / BTUST <i>floating</i>			19		
	PMHST / PPMHST / BPMHST <i>floating</i>			19		
	PMHSST / PPMHSST / BPMHSST <i>floating</i>			19		
SOCKETS	SD					24
	CL / PCL				20	
	CCST / PCCST / BCCST <i>floating</i>			18		
	LT		12			
	NC	11				

## Standard DIP

610

. NP

. SP

. F

. 0

. LP

Serie.  
For insulator without center bar  
replace 0 by 1 at the serie n° end.

.	Standard
A	Automatic (Only with pin CC)
H	High temperature insulator
HA	High temperature Automatic ass.

Number of pins

Type of contacts

.=standard

For pitch x2, x3,x4, or other pitch:

Example: 610.20.CC3F.0 (2.54X3=7.62)

Length code  
(only for series for those is needed)

Clip plating option

.	Clip standard on catalog page
A	SC4
B	SC6.VLI
C	SC6.065
?	Etc.

Pin plating option

## Custom DIP

610

. NP

/ 16

. SP

. F

. 0

. LP

Series  
For insulator without center bar  
replace 0 by 1 at the serie n°

.	Standard
A	Automatic (Only with pin CC)
H	High temperature
HA	High temperature Automatic

Number of pins

/ = first version, B,C,... next versions

Number of positions

Type of contacts

Length code  
(only for series for those is needed)

Clip plating option

.	Clip standard on catalog page
A	SC4
B	SC6.VLI
?	Etc.

Pin plating option

.=standard

For pitch x2, x3,x4, or other pitch:

Example: 610.20/16.CC2F.0 (2.54X2=5.08)

To order a special DIP

Customer			
Address			
ZIP	City		
Country			
Phone			
Fax			
E-mail			

## DIP

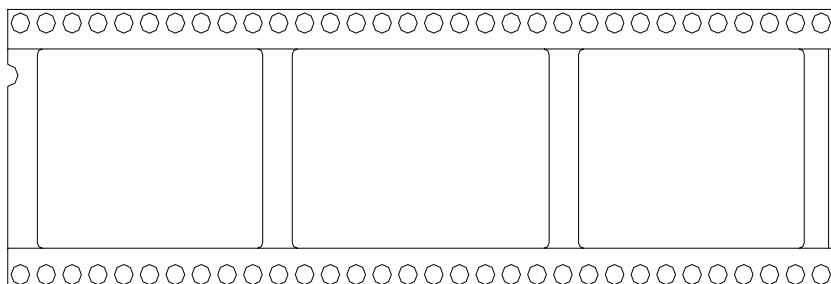

Series	
Type of construction	
Number of pins	
Number of positions	
Type of contact (can be yours)	
Pin plating option	
Type of clip (can be yours)	
Clip plating option	
Length code (if requested)	

Fill in the holes where you want the contacts. If your request isn't standard, please send us a detailed drawing. For the very specific design, insulator is made in Epoxy.

DIP 2.54mm pitch / Sockets / Solder tail /  
Mating pin 0.47mm / 0.76 / Open frame precision

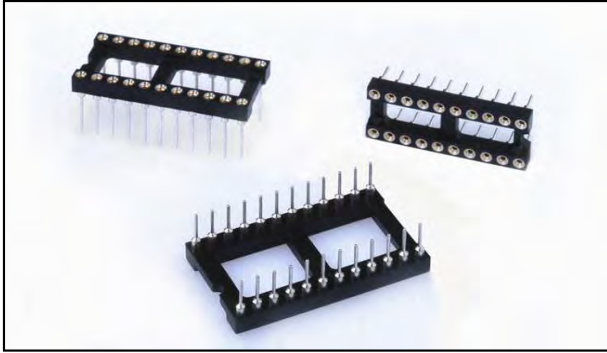

			Pin style	CC / CJ / CM
			Plating sleeve (pin)	5.0µm Tin
			Plating contact (clip)	Au 24c flash
A	B	C	NP Nbr PIN	ORDERING NUMBERS
12.6	7.6	5.08	10	650.10.SP.F.0
NP/2 x 2.54	10.1	7.62	04 06 08 10 12 14 16 18* 20* 22* 24* 28*	610.NP.SP.F.0
NP/2 x 2.54	12.6	10.16	20* 22* 24* 28* 32*	640.NP.SP.F.0
NP/2 x 2.54	17.7	15.24	10 24* 28* 32* 36* 40* 42* 48* 50* 52*	630.NP.SP.F.0
NP/2 x 2.54	25.3	22.86	50 52 64	911.NP.SP.F.0
* For insulator without center bar replace 0 by 1 at the serie N° end. Example: 611.20.CC.F.0				

CC / CJ / CM			
SP	CC	CJ	CM
PIN LENGTH X	2.9mm	4.1mm	7mm

TECHNICAL DATA	
<b>Temperature range</b>	-55°C to +125°C
<b>Insulator body</b>	Glass filled thermoplastic polyester, self-extinguishing, rated UL94V-0 PCB = standard PCT = high temperature (order with H) Example: 630H28.CC.F.0
<b>Outer shell (sleeve)</b>	Screw machined Brass CuZn36Pb3 (C36000) Soft brass pin (order with A -Automatic version- instead of the mark or after H) Example: 630HA40.CC.F.0
<b>Inner spring contact SC4</b>	Stamped and formed BeCu (C17200) gold or tin plated, accepts Ø0.40-0.56 or rectangular pin 0.25 x 0.45
<b>Insertion / Extraction</b>	Ø0.43 test pin Other forces available upon request.

Standard SC4		SC6.VLI	
Insertion	320g max.	Insertion	70g max.
Extraction	50g min.	Extraction	10g min.

To order with inner spring type SC6.VLI, add letter B after F instead of the mark.

Examples: 630.28.CC.FB0 or 630H28.CJ.FB0

**Other mating pin available upon request**

To order with inner spring type SC6.065 (insertion Ø0.65-0.85), add letter C after F instead of the mark.

Example: 630.40.CC.FC0

ELECTRICAL DATA	
<b>Rated current</b>	1A
<b>Maxi working voltage</b>	100V <sub>RMS</sub> / 150 V <sub>dc</sub>
<b>Contact resistance</b>	10 mΩ max
<b>Dielectric strength</b>	1000 V <sub>RMS</sub> min

PLATING OPTIONS	
Sleeve (pin), change letter F (5.0µm standard Tin) by:	
➤ .C	0.25µm gold plating
➤ .O	gold flash
➤ .D	tin / lead non-RoHS
Contact (clip), change suffix 0 (standard Au 24c flash) by:	
➤ .1	0.25µm average Au
➤ .2	0.50µm average Au
➤ .3	0.75µm average Au
➤ .4	0.75µm minimum 24c Au (MIL STD)
➤ .6	5.0µm tin
➤ .00	5.0µm tin / lead non-RoHS

DIP 2.54mm pitch / Sockets / Solder tail /  
Mating pin 0.47mm / Very low profile

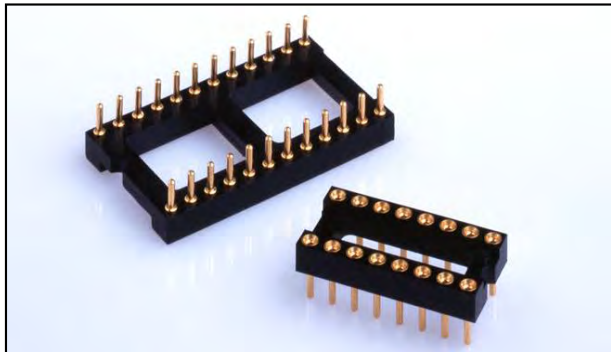

			Pin style	LV
			Plating sleeve (pin)	5.0µm Tin
			Plating contact (clip)	Au 24c flash
A	B	C	NP Nbr PIN	ORDERING NUMBERS
12.6	7.6	5.08	10	650.10.LV.F.0
NP/2 x 2.54	10.1	7.62	04 06 08 10 12 14 16 18 20 22 24 28	610.NP.LV.F.0
NP/2 x 2.54	12.6	10.16	20 22 24 28 32	640.NP.LV.F.0
NP/2 x 2.54	17.7	15.24	10 24 28 32 36 40 42 48 50 52	630.NP.LV.F.0
NP/2 x 2.54	25.3	22.86	50 52 64	911.NP.LV.F.0

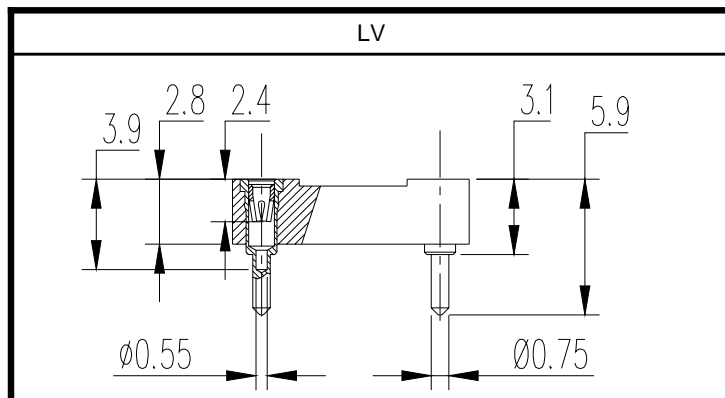

## TECHNICAL DATA

<b>Temperature range</b>	-55°C to +125°C
<b>Insulator body</b>	Glass filled thermoplastic polyester, self-extinguishing, rated UL94V-0 PCB = standard PCT = high temperature (order with H) Example: 630H28.LV.F.0
<b>Outer shell (sleeve)</b>	Screw machined Brass CuZn36Pb3 (C36000)
<b>Inner spring contact SC4</b>	Stamped and formed BeCu (C17200) gold or tin plated, accepts Ø0.40-0.56 or rectangular pin 0.25 x 0.45
<b>Insertion / Extraction</b>	Ø0.43 test pin Other forces available upon request.

## PLATING OPTIONS

Sleeve (pin), change letter F (5.0µm standard Tin) by:

- .C 0.25µm gold plating
- .O gold flash
- .D tin / lead non-RoHS

Contact (clip), change suffix 0 (standard Au 24c flash) by:

- .1 0.25µm average Au
- .2 0.50µm average Au
- .3 0.75µm average Au
- .4 0.75µm minimum 24c Au (MIL STD)
- .6 5.0µm tin
- .00 5.0µm tin / lead non-RoHS

Standard SC4		SC6.VLI	
Insertion	320g max.	Insertion	70g max.
Extraction	50g min.	Extraction	10g min.

To order with inner spring type SC6.VLI, add letter B after F instead of the mark.

Example: 630.28.LV.FB0

## ELECTRICAL DATA

<b>Rated current</b>	1A
<b>Maxi working voltage</b>	100V <sub>RMS</sub> / 150 V <sub>dc</sub>
<b>Contact resistance</b>	10 mΩ max
<b>Dielectric strength</b>	1000 V <sub>RMS</sub> min

DIP 2.54mm pitch / Sockets / Solder tail /  
Mating pin 0.47mm / Open frame precision /  
Elevated pin

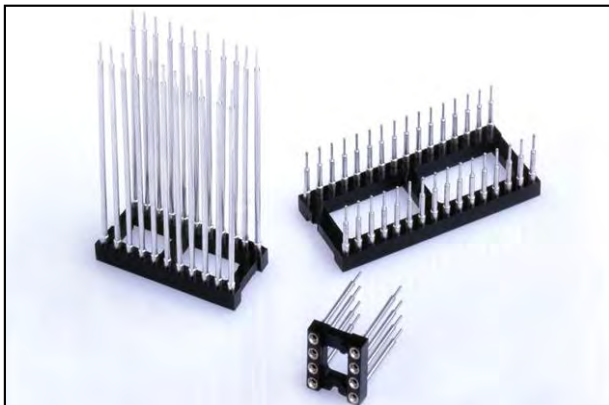

			Pin style	LC
			Plating sleeve (pin)	5.0µm Tin
			Plating contact (clip)	Au 24c flash
A	B	C	NP Nbr PIN	ORDERING NUMBERS
12.6	7.6	5.08	10	650.10.LC.F.0.LP
NP/2 x 2.54	10.1	7.62	04 06 08 10 12 14 16 18 20 22 24 28	610.NP.LC.F.0.LP
NP/2 x 2.54	12.6	10.16	20 22 24 28 32	640.NP.LC.F.0.LP
NP/2 x 2.54	17.7	15.24	10 24 28 32 36 40 42 48 50 52	630.NP.LC.F.0.LP
NP/2 x 2.54	25.3	22.86	50 52 64	911.NP.LC.F.0.LP

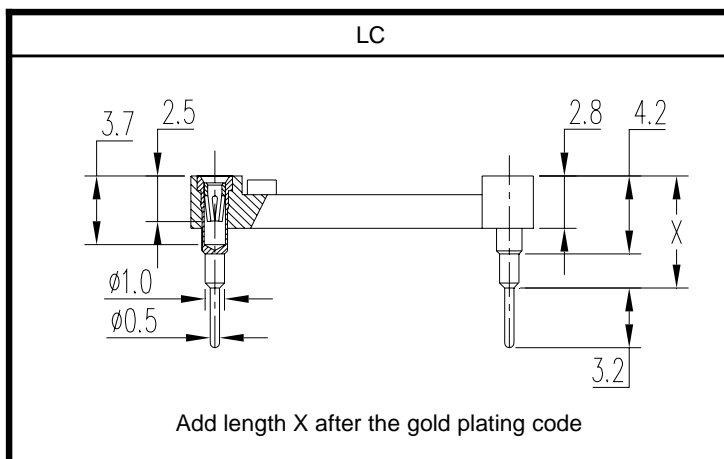

LP PIN LENGTH X (in mm) Other pin length X upon request					
5.6	6.0	7.0	8.0	9.0	10.2
12.0	13.5	15.1	16.3	18.0	22.0
29.0	33.0	35.0			

PLATING OPTIONS	
Sleeve (pin), change letter F (5.0µm standard Tin) by:	
➤ .C	0.25µm gold plating
➤ .O	gold flash
➤ .D	tin / lead non-RoHS

Contact (clip), change suffix 0 (standard Au 24c flash) by:	
➤ .1	0.25µm average Au
➤ .2	0.50µm average Au
➤ .3	0.75µm average Au
➤ .4	0.75µm minimum 24c Au (MIL STD)
➤ .6	5.0µm tin
➤ .00	5.0µm tin / lead non-RoHS

TECHNICAL DATA	
<b>Temperature range</b>	-55°C to +125°C
<b>Insulator body</b>	Glass filled thermoplastic polyester, self-extinguishing, rated UL94V-0 PCB = standard PCT = high temperature (order with H) Example: 630H28.LC.F.0.8.0
<b>Outer shell (sleeve)</b>	Screw machined Brass CuZn36Pb3 (C36000)
<b>Inner spring contact SC4</b>	Stamped and formed BeCu (C17200) gold or tin plated, accepts Ø0.40-0.56 or rectangular pin 0.25 x 0.45
<b>Insertion / Extraction</b>	Ø0.43 test pin Other forces available upon request.

Standard SC4		SC6.VLI	
Insertion	320g max.	Insertion	70g max.
Extraction	50g min.	Extraction	10g min.

To order with inner spring type SC6.VLI, add letter B after F instead of the mark.

Example: 630.28.LC.FB0.6.0

ELECTRICAL DATA	
<b>Rated current</b>	1A
<b>Maxi working voltage</b>	100V <sub>RMS</sub> / 150 V <sub>dc</sub>
<b>Contact resistance</b>	10 mΩ max
<b>Dielectric strength</b>	1000 V <sub>RMS</sub> min



DIP 2.54mm pitch / Sockets / Wire-wrap /  
Mating pin 0.47mm / Open frame precision

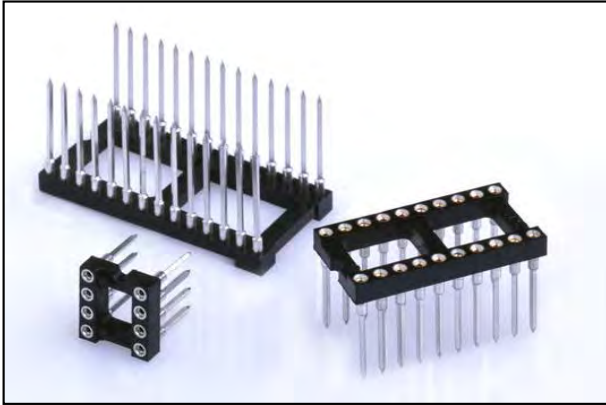

			Pin style	AB / BB / AA / BA
			Plating sleeve (pin)	5.0µm Tin
			Plating contact (clip)	Au 24c flash
A	B	C	NP Nbr PIN	ORDERING NUMBERS
12.6	7.6	5.08	10	650.10.SP.F.0
NP/2 x 2.54	10.1	7.62	04 06 08 10 12 14 16 18 20 22 24 28	610.NP.SP.F.0
NP/2 x 2.54	12.6	10.16	20 22 24 28 32	640.NP.SP.F.0
NP/2 x 2.54	17.7	15.24	10 24 28 32 36 40 42 48 50 52	630.NP.SP.F.0
NP/2 x 2.54	25.3	22.86	50 52 64	911.NP.SP.F.0

AB / BB / AA / BA				
SP	AB	BB	AA	BA
PIN LENGTH X	6.6mm	9.4mm	12.95mm	16.0mm

## TECHNICAL DATA

<b>Temperature range</b>	-55°C to +125°C
<b>Insulator body</b>	Glass filled thermoplastic polyester, self-extinguishing, rated UL94V-0 PCB = standard PCT = high temperature (order with H) Example: 630H28.BB.F.0
<b>Outer shell (sleeve)</b>	Screw machined Brass CuZn36Pb3 (C36000)
<b>Inner spring contact SC4</b>	Stamped and formed BeCu (C17200) gold or tin plated, accepts Ø0.40-0.56 or rectangular pin 0.25 x 0.45
<b>Insertion / Extraction</b>	Ø0.43 test pin Other forces available upon request.

Standard SC4		SC6.VLI	
Insertion	320g max.	Insertion	70g max.
Extraction	50g min.	Extraction	10g min.

To order with inner spring type SC6.VLI, add letter B after F instead of the mark.

Examples: 630.28.AB.FB0 or 630H28.BB.FB0

## ELECTRICAL DATA

<b>Rated current</b>	1A
<b>Maxi working voltage</b>	100V <sub>RMS</sub> / 150 V <sub>dc</sub>
<b>Contact resistance</b>	10 mΩ max
<b>Dielectric strength</b>	1000 V <sub>RMS</sub> min

## PLATING OPTIONS

Sleeve (pin), change letter F (5.0µm standard Tin) by:

- .C 0.25µm gold plating
- .O gold flash
- .D tin / lead non-RoHS

Contact (clip), change suffix 0 (standard Au 24c flash) by:

- .1 0.25µm average Au
- .2 0.50µm average Au
- .3 0.75µm average Au
- .4 0.75µm minimum 24c Au (MIL STD)
- .6 5.0µm tin
- .00 5.0µm tin / lead non-RoHS

# DSMIElectronics SA

# SERIES 6100,6300,6301

DIP 2.54mm pitch / Sockets / Solder tail /  
Mating pin 0.47mm / Open frame precision /  
Automatic assembly

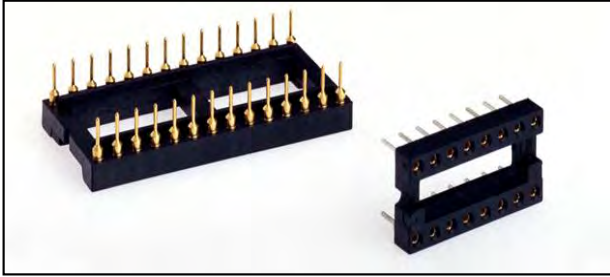

			Pin style	NC
			Plating sleeve (pin)	5.0µm Tin
			Plating contact (clip)	Au 24c flash
A	B	C	NP Nbr PIN	ORDERING NUMBERS
NP/2 x 2.54	10.1	7.62	14 16 18 20 24	6100.NP.NC.F.0
NP/2 x 2.54	17.7	15.24	24 28 40	6300.NP.NC.F.0

<p>Without center bar</p>			Pin style	NC
			Plating Sleeve (pin)	5.0µm Tin
			Plating contact (clip)	Au 24c flash
A	B	C	NP Nbr PIN	ORDERING NUMBERS
NP/2 x 2.54	17.7	15.24	24 28 40	6301.NP.NC.F.0

To order without stand-off, add the suffix WST after the gold plating code.  
Example: 6300.28.NC.D.0WST

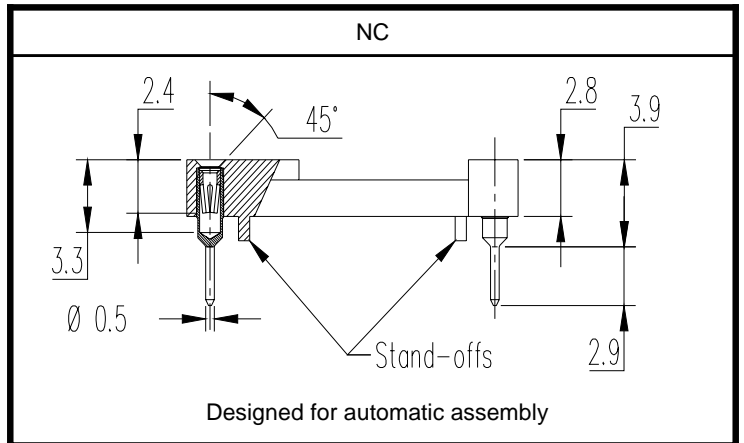

TECHNICAL DATA	
<b>Temperature range</b>	-55°C to +125°C
<b>Insulator body</b>	Glass filled thermoplastic polyester, self-extinguishing, rated UL94V-0 Zytel = standard PCT = high temperature (order with H) Please contact us for availability Example: 6300H28.NC.F.0
<b>Outer shell (sleeve)</b>	Screw machined Brass CuZn36Pb3 (C36000)
<b>Inner spring contact SC4</b>	Stamped and formed BeCu (C17200) gold or tin plated, accepts Ø0.40-0.56 or rectangular pin 0.25 x 0.45
<b>Insertion / Extraction</b>	Ø0.43 test pin Other forces available upon request.

Standard SC4		SC6.VLI	
Insertion	320g max.	Insertion	70g max.
Extraction	50g min.	Extraction	10g min.

To order with inner spring type SC6.VLI, add letter B after F instead of the mark.

Example: 6300.28.NC.FB0

PLATING OPTIONS	
Sleeve (pin), change letter F (5.0µm standard Tin) by:	
➤ .C	0.25µm gold plating
➤ .O	gold flash
➤ .D	tin / lead non-RoHS
Contact (clip), change suffix 0 (standard Au 24c flash) by:	
➤ .1	0.25µm average Au
➤ .2	0.50µm average Au
➤ .3	0.75µm average Au
➤ .4	0.75µm minimum 24c Au (MIL STD)
➤ .6	5.0µm tin
➤ .00	5.0µm tin / lead non-RoHS

ELECTRICAL DATA	
<b>Rated current</b>	1A
<b>Maxi working voltage</b>	100V <sub>RMS</sub> / 150 V <sub>dc</sub>
<b>Contact resistance</b>	10 mΩ max
<b>Dielectric strength</b>	1000 V <sub>RMS</sub> min

DIP 2.54mm pitch / Sockets and Headers /  
Solder tail / Mating pin 0.47mm / Ultra low profile

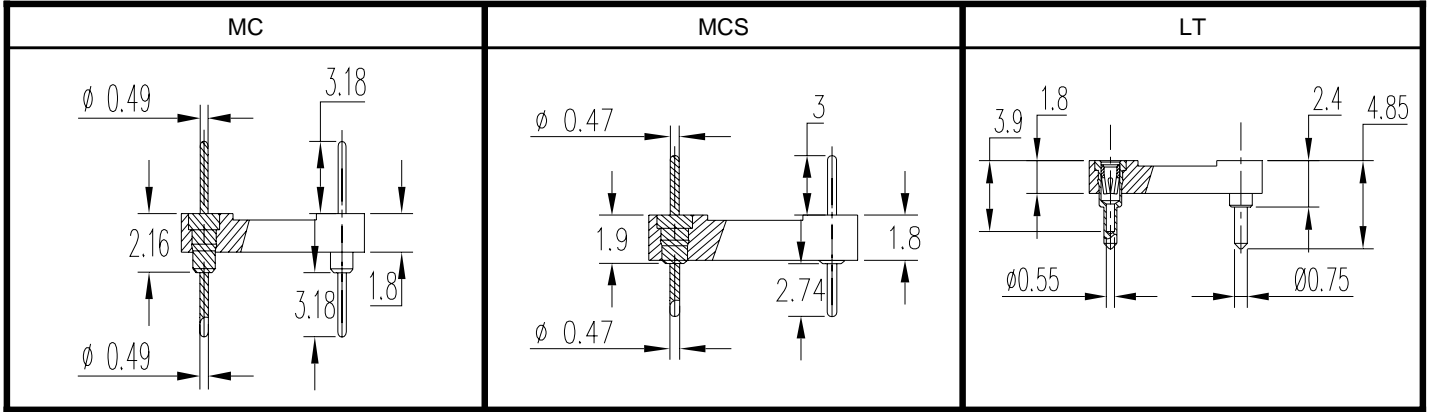
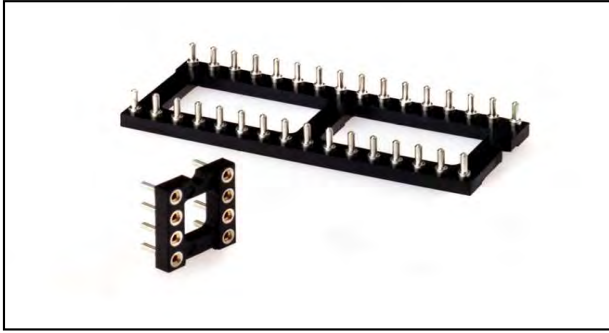

			Pin style	MC / MCS / LT
			Plating sleeve (pin)	5.0µm Tin
			Plating contact (clip)	Au 24c flash
A	B	C	NP Nbr PIN	ORDERING NUMBERS
NP/2 x 2.54	10.1	7.62	06 08 10 14 16 18 20 22 24 28	510.NP.SP.F.0
NP/2 x 2.54	12.6	10.16	20 22 24 28	540.NP.SP.F.0
NP/2 x 2.54	17.7	15.24	24 28 32 36 40 48 50	530.NP.SP.F.0
<p>* Other pin options can be fitted to the ultra low plastic insulator body. Send your exact technical requirement to the factory with a drawing and quantities.</p>				



## TECHNICAL DATA

<b>Temperature range</b>	-55°C to +125°C
<b>Insulator body</b>	Glass filled thermoplastic polyester, self-extinguishing, rated UL94V-0 PCB = standard PCT = high temperature (order with H) Example: 530H28.LT.F.0
<b>Outer shell (sleeve)</b>	Screw machined Brass CuZn36Pb3 (C36000)
<b>Inner spring contact SC4</b>	Stamped and formed BeCu (C17200) gold or tin plated, accepts Ø0.40-0.56 or rectangular pin 0.25 x 0.45
<b>Insertion / Extraction</b>	Ø0.43 test pin Other forces available upon request.

Standard SC4.SH		SC4	
Insertion	350g max.	Insertion	320g max.
Extraction	100g min.	Extraction	50g min.

To order with inner spring type SC4, add letter A after F instead of the mark.  
Example: 510.28.LT.FA0

## PLATING OPTIONS

Sleeve (pin), change letter F (5.0µm standard Tin) by:

- .C 0.25µm gold plating
- .O gold flash
- .D tin / lead non-RoHS

Contact (clip), change suffix 0 (standard Au 24c flash) by:

- .1 0.25µm average Au
- .2 0.50µm average Au
- .3 0.75µm average Au
- .4 0.75µm minimum 24c Au (MIL STD)
- .6 5.0µm tin
- .00 5.0µm tin / lead non-RoHS

## ELECTRICAL DATA

<b>Rated current</b>	1A
<b>Maxi working voltage</b>	100V <sub>RMS</sub> / 150 V <sub>dc</sub>
<b>Contact resistance</b>	10 mΩ max
<b>Dielectric strength</b>	1000 V <sub>RMS</sub> min

DIP 2.54mm pitch / Sockets / Solder tail /  
Mating pin 0.47mm / Right angle / Opened

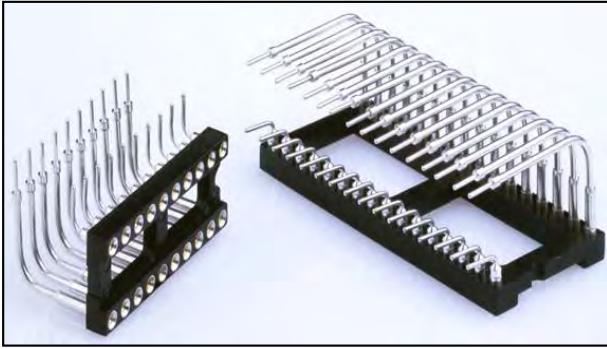

				Pin style	CLR / CLR1
				Plating sleeve (pin)	5.0µm Tin
				Plating contact (clip)	Au 24c flash
A	B	C	D	NP Nbr PIN	ORDERING NUMBERS
NP/2 x 2.54	7.6	5.08	CLR = 5.08	10	650.10.CLR.F.0
NP/2 x 2.54	10.1	7.62	CLR = 7.62 CLR1 = 2.54	04 06 08 10 14 16 18 20 22 24 28	610.NP.SP.F.0
NP/2 x 2.54	12.6	10.16	CLR = 7.62	22 24 28 32	640.NP.CLR.F.0
NP/2 x 2.54	17.7	15.24	CLR = 7.62	16 24 28 32 36 40 42 48 50 52	630.NP.CLR.F.0

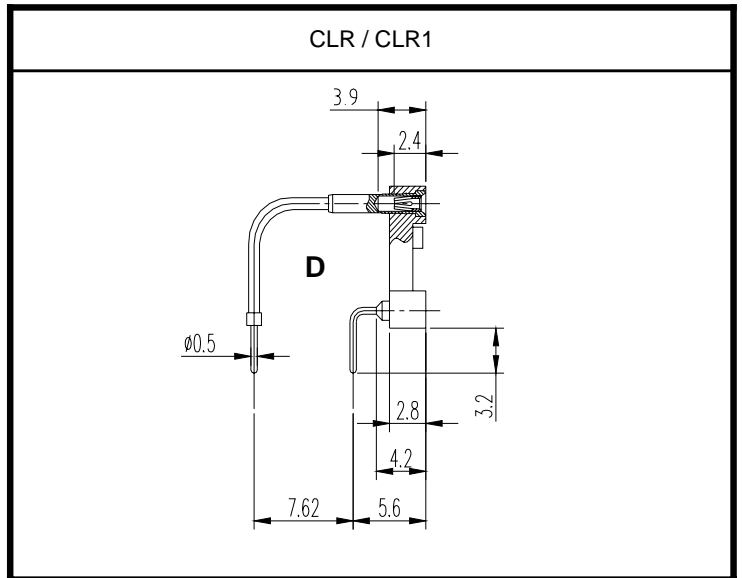

### TECHNICAL DATA

**Temperature range** -55°C to +125°C

**Insulator body** Glass filled thermoplastic polyester, self-extinguishing, rated UL94V-0  
PCB = standard  
PCT = high temperature (order with H)  
Example: 630H28.CLR.F.0

**Outer shell (sleeve)** Screw machined Brass CuZn36Pb3 (C36000)

**Inner spring contact SC4** Stamped and formed BeCu (C17200) gold or tin plated, accepts Ø0.40-0.56 or rectangular pin 0.25 x 0.45

**Insertion / Extraction** Ø0.43 test pin  
Other forces available upon request.

Standard SC4		SC6.VLI	
Insertion	320g max.	Insertion	70g max.
Extraction	50g min.	Extraction	10g min.

To order with inner spring type SC6.VLI, add letter B after F instead of the mark.  
Example: 630.28.CLR.FB0

### PLATING OPTIONS

Sleeve (pin), change letter F (5.0µm standard Tin) by:

- .C 0.25µm gold plating
- .O gold flash
- .D tin / lead non-RoHS

Contact (clip), change suffix 0 (standard Au 24c flash) by:

- .1 0.25µm average Au
- .2 0.50µm average Au
- .3 0.75µm average Au
- .4 0.75µm minimum 24c Au (MIL STD)
- .6 5.0µm tin
- .00 5.0µm tin / lead non-RoHS

### ELECTRICAL DATA

**Rated current** 1A

**Maxi working voltage** 100V<sub>RMS</sub> / 150 V<sub>dc</sub>

**Contact resistance** 10 mΩ max

**Dielectric strength** 1000 V<sub>RMS</sub> min

RR / SS		XX / LL / MM	
FF / JJ / KK		TC / WT / WU	
TT / TU		MC	
PB		TC.SMV (Surface mount)	



			Pin style	RR / SS / XX / LL / MM / FF / JJ / KK / TC / WT / WU / TT / TU / MC / PB / TC.SMV
			Plating sleeve (pin)	5.0µm Tin
A	B	C	NP Nbr PIN	ORDERING NUMBERS
12.6	7.6	5.08	10	650.10.SP.F
NP/2 x 2.54	10.1	7.62	04 06 08 10 14 16 18 20 22 24	610.NP.SP.F
NP/2 x 2.54	12.6	10.16	22 24 28 32	640.NP.SP.F
NP/2 x 2.54	17.7	15.24	10 24 28 32 36 40 42 48 50 52	630.NP.SP.F
NP/2 x 2.54	25.3	22.86	50 52 64	911.NP.SP.F

SP	mm	X	Y	Z
RR		12.95	-	-
SS		9.4	-	-
XX <i>Solder cup strip</i>		3.9	Ø 0.5	-
LL <i>Solder cup strip</i>		12.95	Sq 0.635	-
MM <i>Solder cup strip</i>		9.4	Sq 0.635	-
FF <i>Slotted head strip</i>		3.9	Ø 0.5	-
JJ <i>Slotted head strip</i>		12.95	Sq 0.635	-
KK <i>Slotted head strip</i>		9.4	Sq 0.635	-
TC <i>Turred head strip</i>		3.9	Ø 0.5	-
WT <i>Turred head strip</i>		12.95	Sq 0.635	-
WU <i>Turred head strip</i>		9.4	Sq 0.635	-
TT		4.2	Ø 0.64	4.8
TU		3.7	Ø 0.5	4.3
PB <i>Piggy-back</i>		6.4 / 8.4 / 15.4 / 21.2 / 27.4	-	-

\* This page describes the standards available.  
If you wish other dimensions please contact the factory or submit your technical data.

### PLATING OPTIONS

Sleeve (pin), change letter F (5.0µm standard Tin) by:

- .C 0.25µm gold plating
- .O gold flash
- .D tin / lead non-RoHS
- .S 0.25µm gold plating (connecting side)  
5µm tin (PCB side)
- .S only available for MC style

### TECHNICAL DATA

**Temperature range** -55°C to +125°C  
**Insulator body** Glass filled thermoplastic polyester, self-extinguishing, rated UL94V-0  
 PCB = standard  
 PCT = high temperature (order with H)  
 Example: 630H28.TT.F  
**Outer shell (sleeve)** Screw machined Brass CuZn36Pb3 (C36000)

To order the Piggy-back, change LP by length X.  
Example: 630.32.PB.F.15.4

### ELECTRICAL DATA

**Rated current** 1A  
**Maxi working voltage** 100V<sub>RMS</sub> / 150 V<sub>dc</sub>  
**Contact resistance** 10 mΩ max  
**Dielectric strength** 1000 V<sub>RMS</sub> min



DIP 2.54mm pitch / Sockets / Solder tail /  
 Mating pin 0.47mm / 0.76 /  
 Closed frame precision

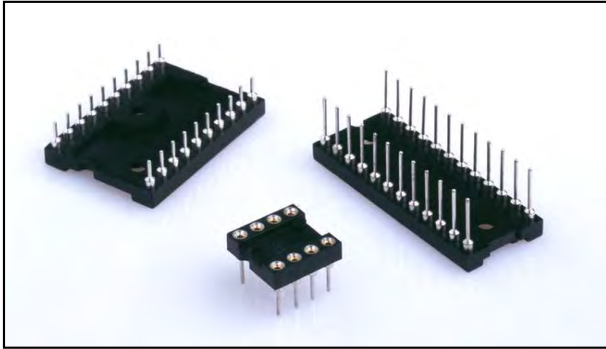

			Pin style	
			Plating sleeve (pin)	5.0µm Tin
			Plating contact (clip)	Au 24c flash
A	B	C	NP Nbr PIN	ORDERING NUMBERS
NP/2 x 2.54	10.1	7.62	04 06 08 10 12 14 16 18 20 22 24	102.NP.SP.F.0
NP/2 x 2.54	12.6	10.16	22 24 (*1)	400.NP.SP.F.0
NP/2 x 2.54	17.7	15.24	24 28 32 36 40 48 (*1)	300.NP.SP.F.0
*1) Availability from 4 positions				

All the open versions can be ordered in closed ones by changing the serie code.

<b>TO ORDER CLOSED DIP</b>	
Replace	610 by 102 630 by 300 640 by 400
Examples:	
630.40.CC.F.0	300.40.CC.F.0
610.10.TT.F	102.10.TT.F
640.22.CC.C.4	400.22.CC.C.4
630.28.CLR.F.1	300.28.CLR.F.1
610.20.LC.F.0.6.0	102.20.LC.F.0.6.0
640.24.FF.C	400.24.FF.C
610.04.AA.F.0	102.04.AA.F.0
etc.	
All pin styles are available for both open and closed versions.	

DIP 2.54mm pitch / Sockets / Solder tail /  
Wire-wrap / Mating pin 0.47mm /  
Integral decoupling capacitor

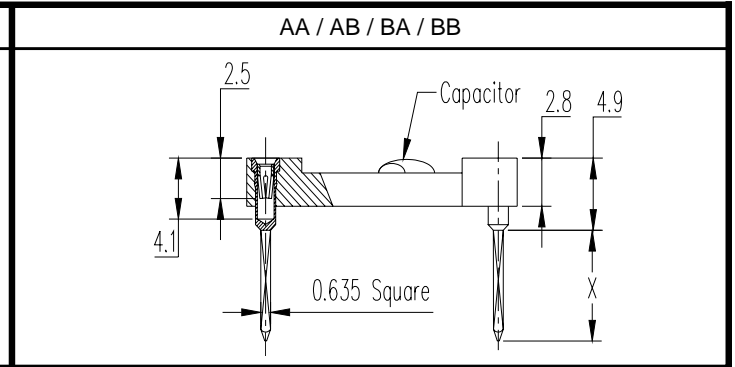
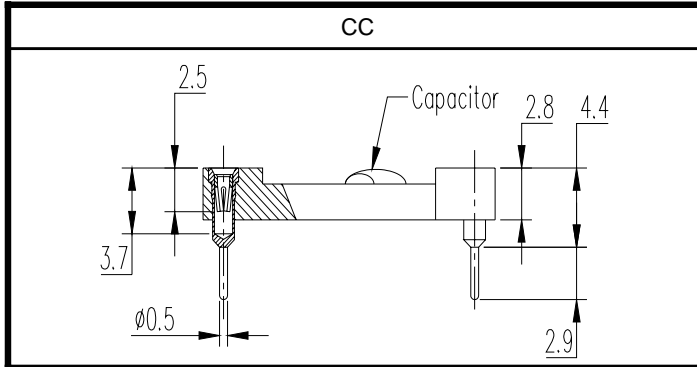
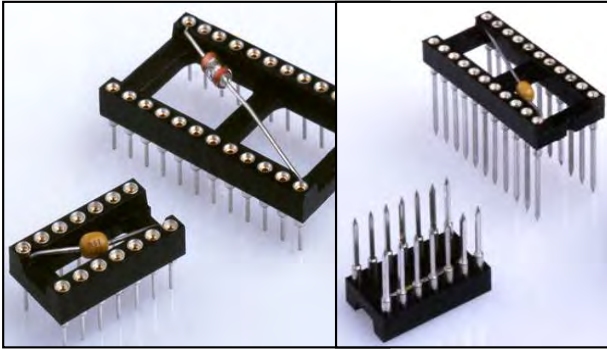

			Pin style	CC / AB / BB / AA / BA
			Plating sleeve (pin)	5.0µm Tin
			Plating contact (clip)	Au 24c flash
A	B	C	NP Nbr PIN	ORDERING NUMBERS
NP/2 x 2.54	10.1	7.62	14 16 18 20 22 24	619.NP.SP.F.0
27.8	12.6	10.16	22	649.22.SP.F.0
NP/2 x 2.54	17.7	15.24	24 28 40	639.NP.SP.F.0

SP	CC	AA	AB	BA	BB
PIN LENGTH X	2.9mm	12.95mm	6.6mm	16.0mm	9.4mm

## TECHNICAL DATA

**Temperature range** -25°C to +85°C

**Insulator body** Glass filled thermoplastic polyester, self-extinguishing, rated UL94V-0  
PCB = standard  
PCT = high temperature (order with H)  
Example: 639H28.CC.F.0

**Outer shell (sleeve)** Screw machined Brass CuZn36Pb3 (C36000)

**Inner spring contact SC4** Stamped and formed BeCu (C17200) gold or tin plated, accepts Ø0.40-0.56 or rectangular pin 0.25 x 0.45

**Insertion / Extraction** Ø0.43 test pin  
Other forces available upon request.

Standard SC4	
Insertion	320g max.
Extraction	50g min.

## PLATING OPTIONS

Sleeve (pin), change letter F (5.0µm standard Tin) by:

- .C 0.25µm gold plating
- .O gold flash
- .D tin / lead non-RoHS

Contact (clip), change suffix 0 (standard Au 24c flash) by:

- .1 0.25µm average Au
- .2 0.50µm average Au
- .3 0.75µm average Au
- .4 0.75µm minimum 24c Au (MIL STD)
- .6 5.0µm tin
- .00 5.0µm tin / lead non-RoHS

## ELECTRICAL DATA

**Capacitor value** 0.1µF (another value upon request)

**Rated current** 1A

**Maxi working voltage** 100V<sub>RMS</sub> / 150 V<sub>dc</sub>

**Contact resistance** 10 mΩ max

**Dielectric strength** 1000 V<sub>RMS</sub> min

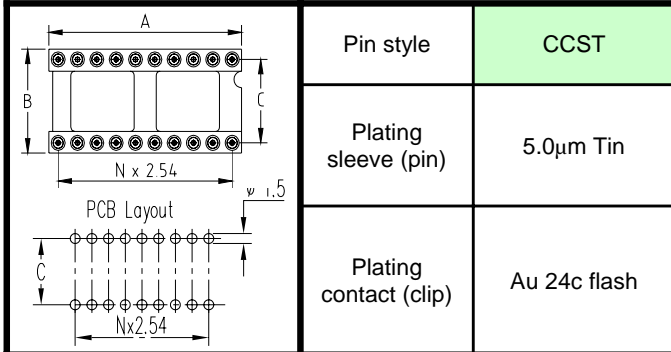

Pin style	CCST
Plating sleeve (pin)	5.0µm Tin
Plating contact (clip)	Au 24c flash

A	B	C	NP Nbr PIN	ORDERING NUMBERS
12.6	7.6	5.08	10	5102H10.SP.F.0
NP/2 x 2.54	10.1	7.62	04 06 08 10 14 16 18 20 22 24 28	1102HNP.SP.F.0
NP/2 x 2.54	12.6	10.16	22 24 28 32	4400HNP.SP.F.0
NP/2 x 2.54	17.7	15.24	24 28 32 36 40 42 48	3300HNP.SP.F.0

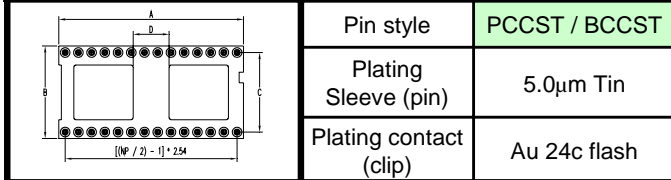

Pin style	PCCST / BCCST
Plating Sleeve (pin)	5.0µm Tin
Plating contact (clip)	Au 24c flash

A	B	C	NP Nbr PIN	ORDERING NUMBERS
12.6	7.6	5.08	10	5102H10.SP.F.0
NP/2 x 2.54	10.1	7.62	*04 *06 *08 *10 *14 *16 *18 *20 *22 *24 *28	1102HNP.SP.F.0
NP/2 x 2.54	12.6	10.16	22 24 28 32	4400HNP.SP.F.0
NP/2 x 2.54	17.7	15.24	24 *28 *32 36 *40 *42 48	3300HNP.SP.F.0

Actually only \* positions are available on stock. For other versions, contact the customer service.

## PLATING OPTIONS

Sleeve (pin), change letter F (5.0µm standard Tin) by:

- .C 0.25µm gold plating
- .D tin / lead non-RoHS

Contact (clip), change suffix 0 (standard Au 24c flash) by:

- .1 0.25µm average Au
- .2 0.50µm average Au
- .3 0.75µm average Au
- .4 0.75µm minimum 24c Au (MIL STD)
- .6 5.0µm tin
- .00 5.0µm tin / lead non-RoHS

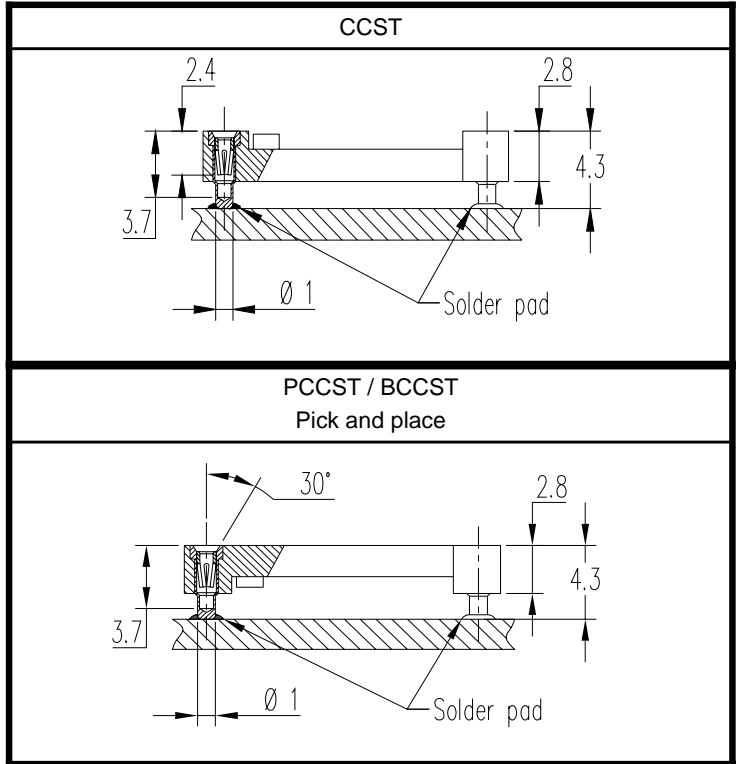

## TECHNICAL DATA

<b>Temperature range</b>	-55°C to +125°C
<b>Insulator body</b>	Glass filled thermoplastic polyester, self-extinguishing, rated UL94V-0 PCT = high temperature
<b>Outer shell (sleeve)</b>	Screw machined Brass CuZn36Pb3 (C36000)
<b>Inner spring contact SC4</b>	Stamped and formed BeCu (C17200) gold or tin plated, accepts Ø0.40-0.56 or rectangular pin 0.25 x 0.45
<b>Insertion / Extraction</b>	Ø0.43 test pin Other forces available upon request.

Standard SC4	
Insertion	320g max.
Extraction	50g min.

For socket pick and place

PCCST	with standard packaging tube
BCCST	with tape & reel packaging
Examples:	1102H28.PCCST.F.0 (tube) 1102H28.BCCST.F.0 (blister)

## ELECTRICAL DATA

<b>Rated current</b>	1A
<b>Maxi working voltage</b>	100V <sub>RMS</sub> / 150 V <sub>dc</sub>
<b>Contact resistance</b>	10 mΩ max
<b>Dielectric strength</b>	1000 V <sub>RMS</sub> min

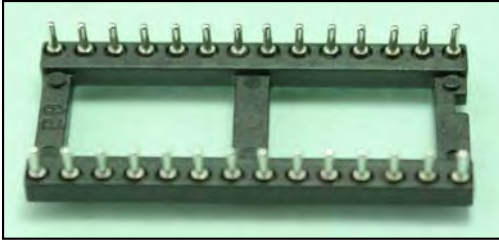

			Pin style	TUST / PMHST / PMHSST
			Plating sleeve (pin)	5.0µm Tin
A	B	C	NP Nbr PIN	ORDERING NUMBERS
12.6	7.6	5.08	10	5102H10.SP.F.0
NP/2 x 2.54	10.1	7.62	04 06 08 10 14 16 18 20 22 24 28	1102HNP.SP.F.0
NP/2 x 2.54	12.6	10.16	22 24 28 32	4400HNP.SP.F.0
NP/2 x 2.54	17.7	15.24	24 28 32 36 40 42 48	3300HNP.SP.F.0
			Pin style	PTUST / PPMHST / PPMHSST
			Plating Sleeve (pin)	5.0µm Tin
A	B	C	NP Nbr PIN	ORDERING NUMBERS
12.6	7.6	5.08	10	5102H10.SP.F.0
NP/2 x 2.54	10.1	7.62	*04 *06 *08 *10 *14 *16 *18 *20 *22 *24 *28	1102HNP.SP.F.0
NP/2 x 2.54	12.6	10.16	22 24 28 32	4400HNP.SP.F.0
NP/2 x 2.54	17.7	15.24	24 *28 *32 36 *40 *42 48	3300HNP.SP.F.0

Actually only \* positions are available on stock. For other versions, contact the customer service.

### PLATING OPTIONS

Sleeve (pin), change letter F (5.0µm standard Tin) by:

- .C 0.25µm gold plating
- .D tin / lead non-RoHS

SP	TUST PTUST	PMHST PPMHST	PMHSST PPMHSST
PIN LENGTH X	3.6mm	5.0mm	3.6mm
PIN LENGTH Y	Ø 0.47mm	Ø 0.76mm	Ø 0.76mm

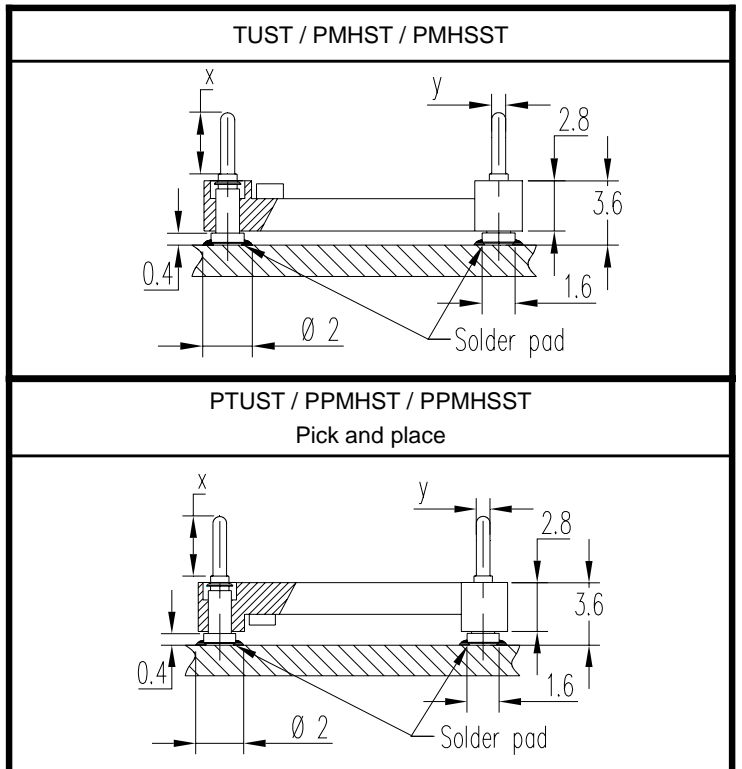

### TECHNICAL DATA

<b>Temperature range</b>	-55°C to +125°C
<b>Insulator body</b>	Glass filled thermoplastic polyester, self-extinguishing, rated UL94V-0 PCT = high temperature
<b>Outer shell (sleeve)</b>	Screw machined Brass CuZn36Pb3 (C36000)

For socket pick and place

PTUST	with standard packaging tube
BTUST	with tape & reel packaging
Examples:	1102H28.PTUST.F.0 (tube) 1102H28.BTUST.F.0 (blister)

### ELECTRICAL DATA

<b>Rated current</b>	1A
<b>Maxi working voltage</b>	100V <sub>RMS</sub> / 150 V <sub>dc</sub>
<b>Contact resistance</b>	10 mΩ max
<b>Dielectric strength</b>	1000 V <sub>RMS</sub> min

DIP 2.54mm pitch / Sockets and Headers /  
Gull wing / Mating pin 0.47mm / Pick & place /  
Surface mount

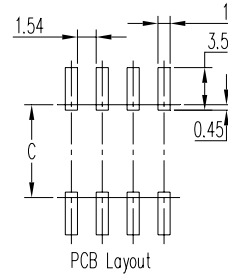
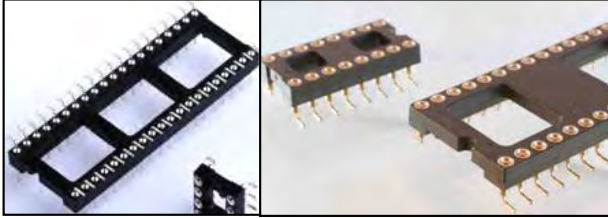

			Pin style	CL / ML
			Plating sleeve (pin)	5.0µm Tin
			Plating contact (clip)	Au 24c flash

A	B	C	NP Nbr PIN	ORDERING NUMBERS
12.6	7.6	5.08	10	5112H10.SP.F.0
NP/2 X 2.54	10.1	7.62	04 06 08 10 14 16 18 20 22 24 28	1112HNP.SP.F.0
NP/2 X 2.54	12.6	10.16	22 24 28 32	4440HNP.SP.F.0
NP/2 X 2.54	17.7	15.24	24 28 32 36 40 42 48	3330HNP.SP.F.0

				Pin style	PCL / BCL / PML / BML
				Plating sleeve (pin)	5.0µm Tin
				Plating contact (clip)	Au 24c flash

A	B	C	D	NP Nbr PIN	ORDERING NUMBERS
12.6	7.6	5.08		10	5112H10.SP.F.0
NP/2 x 2.54	10.1	7.62	5.0 7.6 10.1 12.6 5.3 8.3	04 06* 08* 10* 14* 16* 18* 20* 22* 24* 28*	1112HNP.SP.F.0
NP/2 x 2.54	12.6	10.16	8.3 10	22 24 28 32	4440HNP.SP.F.0
NP/2 x 2.54	17.7	15.24	10	24 28* 32* 36 40* 42* 48	3330HNP.SP.F.0

Actually only \* positions are available on stock. For other versions, contact the customer service.

## PLATING OPTIONS

(only available for ML and PML type)

Sleeve (pin), change letter F (5.0µm standard Tin) by:

- .C 0.25µm gold plating
- .D tin / lead non-RoHS
- .S 0.25µm gold plating (connecting side)  
5µm tin (PCB side)

Contact (clip), change suffix 0 (standard Au 24c flash) by:

- .1 0.25µm average Au
- .2 0.50µm average Au
- .3 0.75µm average Au
- .4 0.75µm minimum 24c Au (MIL STD)
- .6 5.0µm tin
- .00 5.0µm tin / lead non-RoHS

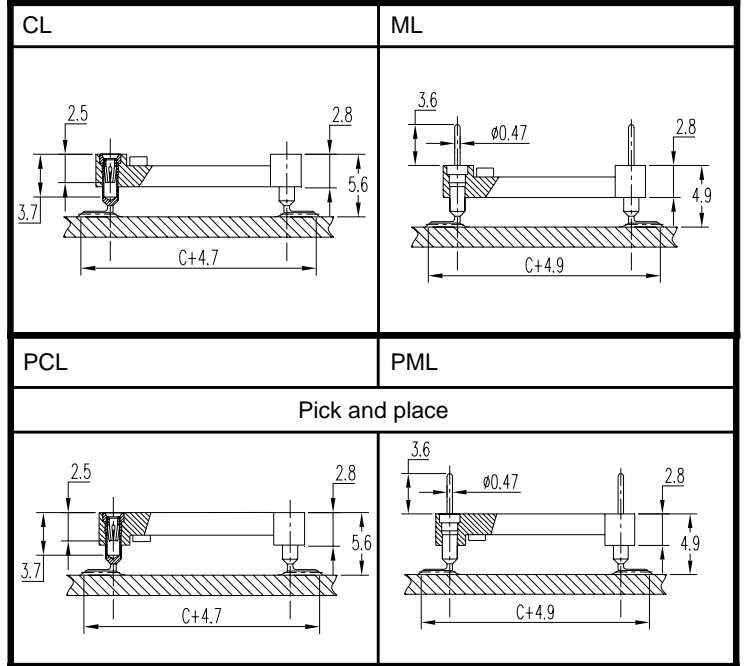

## TECHNICAL DATA

<b>Temperature range</b>	-55°C to +125°C
<b>Insulator body</b>	Glass filled thermoplastic polyester, self-extinguishing, rated UL94V-0 PCT = high temperature
<b>Outer shell (sleeve)</b>	Screw machined Brass CuZn36Pb3 (C36000)
<b>Inner spring contact SC4</b>	Stamped and formed BeCu (C17200) gold or tin plated, accepts Ø0.40-0.56 or rectangular pin 0.25 x 0.45
<b>Insertion / Extraction</b>	Ø0.43 test pin Other forces available upon request.

### Standard SC4

Insertion	320g max.
Extraction	50g min.

For insulator pick and place

PCL / PML with standard packaging tube

BCL / BML with tape & reel packaging

Examples: 1112H28.PCL.F.0 (tube)

1112H28.BCL.F.0 (blister)

## ELECTRICAL DATA

<b>Rated current</b>	1A
<b>Maxi working voltage</b>	100V <sub>RMS</sub> / 150 V <sub>dc</sub>
<b>Contact resistance</b>	10 mΩ max
<b>Dielectric strength</b>	1000 V <sub>RMS</sub> min



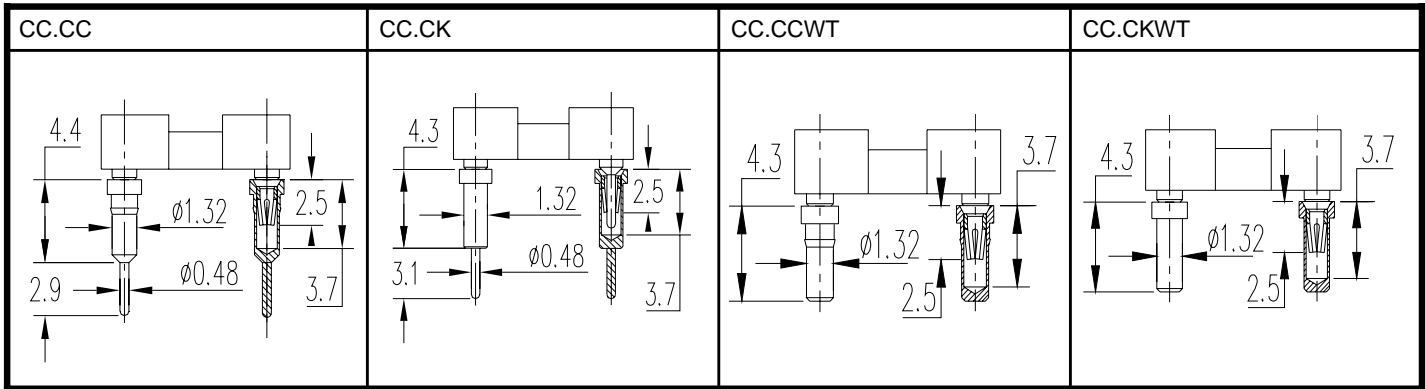
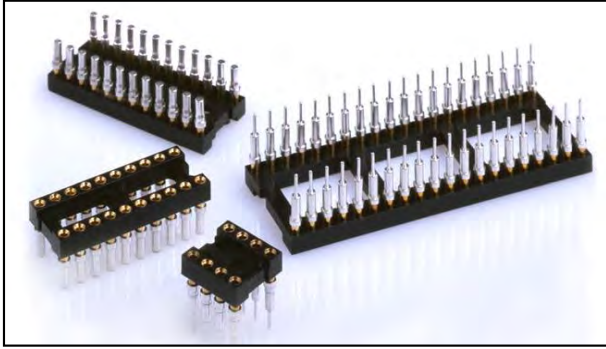

			Pin style	CC.CC / CC.CK / CC.CCWT / CC.CKWT
			Plating sleeve (pin)	5.0µm Tin
			Plating contact (clip)	Au 24c flash
A	B	C	NP Nbr PIN	ORDERING NUMBERS
12.6	7.6	5.08	10	650.10.SP.F.0
NP/2 x 2.54	10.1	7.62	04 06 08 10 12 14 16 18 20 22 24 28	610.NP.SP.F.0
NP/2 x 2.54	12.6	10.16	20 22 24 28 32	640.NP.SP.F.0
NP/2 x 2.54	17.7	15.24	10 24 28 32 36 40 42 48 50 52	630.NP.SP.F.0
NP/2 x 2.54	25.3	22.86	50 52 64	911.NP.SP.F.0

### PLATING OPTIONS

Sleeve (pin), change letter F (5.0µm standard Tin) by:

- .C 0.25µm gold plating
- .O gold flash
- .D tin / lead non-RoHS

Contact (clip), change suffix 0 (standard Au 24c flash) by:

- .1 0.25µm average Au
- .2 0.50µm average Au
- .3 0.75µm average Au
- .4 0.75µm minimum 24c Au (MIL STD)
- .6 5.0µm tin
- .00 5.0µm tin / lead non-RoHS

### TECHNICAL DATA

<b>Temperature range</b>	-55°C to +125°C
<b>Insulator body</b>	Glass filled thermoplastic polyester, self-extinguishing, rated UL94V-0 PCB = standard PCT = high temperature (order with H) Example: 630H28.CC.CK.F.0
<b>Outer shell (sleeve)</b>	Screw machined Brass CuZn36Pb3 (C36000)
<b>Inner spring contact SC4</b>	Stamped and formed BeCu (C17200) gold or tin plated, accepts Ø0.40-0.56 or rectangular pin 0.25 x 0.45
<b>Insertion / Extraction</b>	Ø0.43 test pin Other forces available upon request.

Standard SC4		SC6.VLI	
Insertion	320g max.	Insertion	70g max.
Extraction	50g min.	Extraction	10g min.

To order with inner spring type SC6.VLI, add letter B after F instead of the mark.

Examples: 630.28.CC.CC.FB0  
630.28.CC.CK.FB0  
630.28.CC.CCWT.FB0  
630.28.CC.CKWT.FB0

### ELECTRICAL DATA

<b>Rated current</b>	1A
<b>Maxi working voltage</b>	100V <sub>RMS</sub> / 150 V <sub>dc</sub>
<b>Contact resistance</b>	10 mΩ max
<b>Dielectric strength</b>	1000 V <sub>RMS</sub> min



DIP 2.54mm pitch / Sockets / Solder tail /  
Mating pin 0.47mm / Plastic carrier

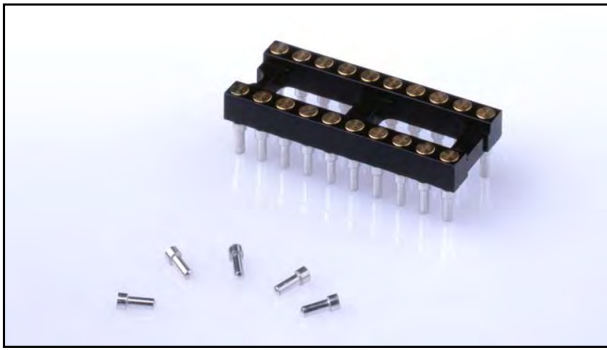

			Pin style	CN.SWT / CN.SWU
			Plating sleeve (pin)	5.0µm Tin
			Plating contact (clip)	Au 24c flash
A	B	C	NP Nbr PIN	ORDERING NUMBERS
12.6	7.6	5.08	10	650.10.SP.F.0
NP/2 x 2.54	10.1	7.62	04 06 08 10 12 14 16 18 20 22 24 28	610.NP.SP.F.0
NP/2 x 2.54	12.6	10.16	20 22 24 28 32	640.NP.SP.F.0
NP/2 x 2.54	17.7	15.24	10 24 28 32 36 40 42 48 50 52	630.NP.SP.F.0
NP/2 x 2.54	25.3	22.86	50 52 64	911.NP.SP.F.0

SP	CN.SWT	CN.SWU
PIN LENGTH X	3.6mm	6.3mm
HOLE DEPTH Y	3.2mm	5.9mm

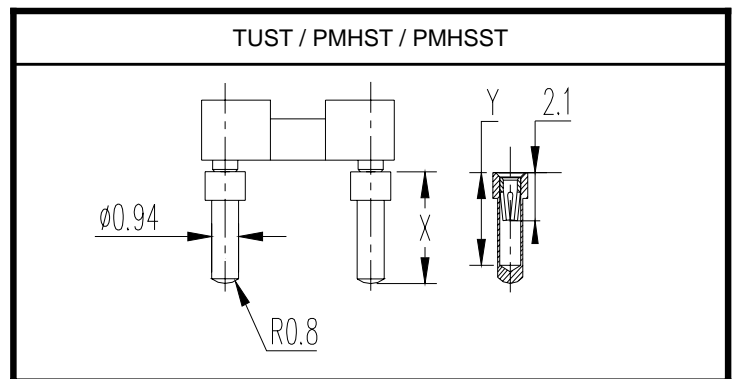

### TECHNICAL DATA

**Temperature range** -55°C to +125°C

**Insulator body** Glass filled thermoplastic polyester, self-extinguishing, rated UL94V-0  
PCB = standard  
PCT = high temperature (order with H)  
Example: 630H28.CN.SWT.F.0

**Outer shell (sleeve)** Screw machined Brass CuZn36Pb3 (C36000)

**Inner spring contact SC3** Stamped and formed BeCu (C17200) gold or tin plated, accepts Ø0.35-0.50

**Insertion / Extraction** Ø0.43 test pin  
Other forces available upon request.

Standard SC3	
Insertion	150g max.
Extraction	30g min.

### PLATING OPTIONS

Sleeve (pin), change letter F (5.0µm standard Tin) by:

- .C 0.25µm gold plating
- .O gold flash
- .D tin / lead non-RoHS

Contact (clip), change suffix 0 (standard Au 24c flash) by:

- .1 0.25µm average Au
- .2 0.50µm average Au
- .3 0.75µm average Au
- .4 0.75µm minimum 24c Au (MIL STD)
- .6 5.0µm tin
- .00 5.0µm tin / lead non-RoHS

### ELECTRICAL DATA

<b>Rated current</b>	1A
<b>Maxi working voltage</b>	100V <sub>RMS</sub> / 150 V <sub>dc</sub>
<b>Contact resistance</b>	10 mΩ max
<b>Dielectric strength</b>	1000 V <sub>RMS</sub> min

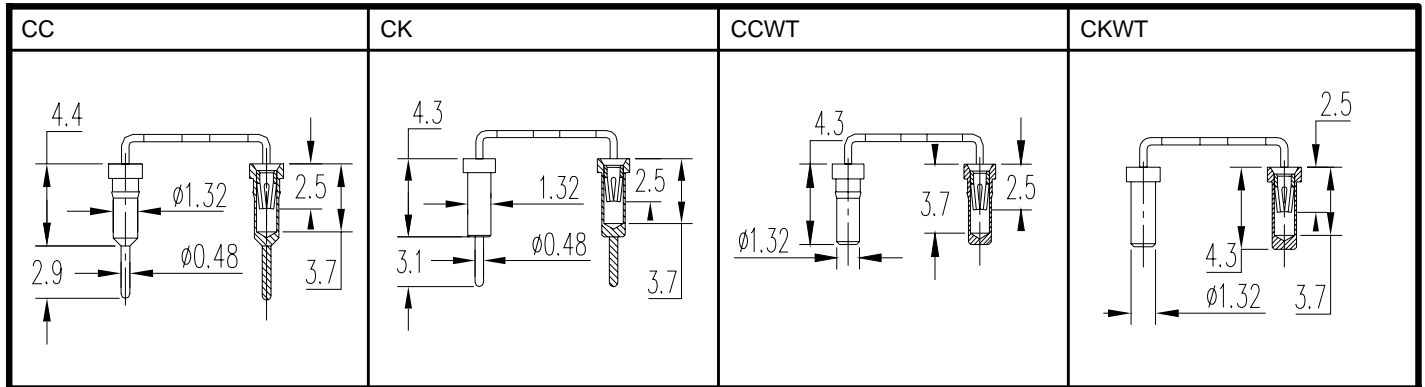
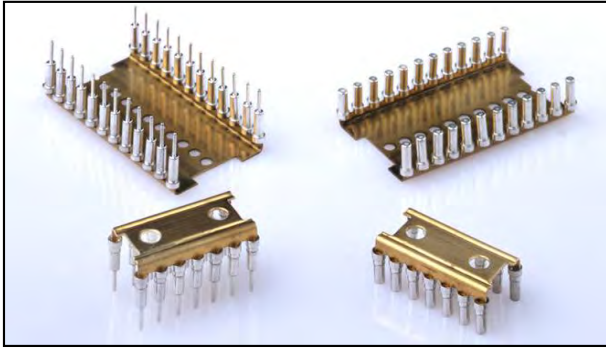

		Pin style	CC / CK / CCWT / CKWT
		Plating sleeve (pin)	5.0µm Tin
		Plating contact (clip)	Au 24c flash
A	C	NP Nbr PIN	ORDERING NUMBERS
NP/2 x 2.54	7.62	14 16 18 20 22 24 28 *1)	900.NP.SP.F.0
NP/2 x 2.54	15.24	22 24 28 32 *1)	960.NP.SP.F.0
*1) Other lengths available upon request. Please contact our customer service.			

## PLATING OPTIONS

Sleeve (pin), change letter F (5.0µm standard Tin) by:

- .C 0.25µm gold plating
- .O gold flash
- .D tin / lead non-RoHS

Contact (clip), change suffix 0 (standard Au 24c flash) by:

- .1 0.25µm average Au
- .2 0.50µm average Au
- .3 0.75µm average Au
- .4 0.75µm minimum 24c Au (MIL STD)
- .6 5.0µm tin
- .00 5.0µm tin / lead non-RoHS

## TECHNICAL DATA

<b>Temperature range</b>	-55°C to +125°C
<b>Carrier body</b>	Brass
<b>Outer shell (sleeve)</b>	Screw machined Brass CuZn36Pb3 (C36000)
<b>Inner spring contact SC4</b>	Stamped and formed BeCu (C17200) gold or tin plated, accepts Ø0.40-0.56 or rectangular pin 0.25 x 0.45
<b>Insertion / Extraction</b>	Ø0.43 test pin Other forces available upon request.

Standard SC4		SC6.VLI	
Insertion	320g max.	Insertion	70g max.
Extraction	50g min.	Extraction	10g min.

To order with inner spring type SC6.VLI, add letter B after F instead of the mark.

Examples: 960.28.CC.FB0  
960.28.CK.FB0  
960.28.CCWT.FB0  
960.28.CKWT.FB0

## ELECTRICAL DATA

	(for Pin)
<b>Rated current</b>	1A
<b>Maxi working voltage</b>	100V <sub>RMS</sub> / 150 V <sub>dc</sub>
<b>Contact resistance</b>	10 mΩ max
<b>Dielectric strength</b>	1000 V <sub>RMS</sub> min

DIP 1.78mm pitch / Sockets /  
Shrinkdip 1.78 spacing solder tail /  
Mating pin 0.47mm

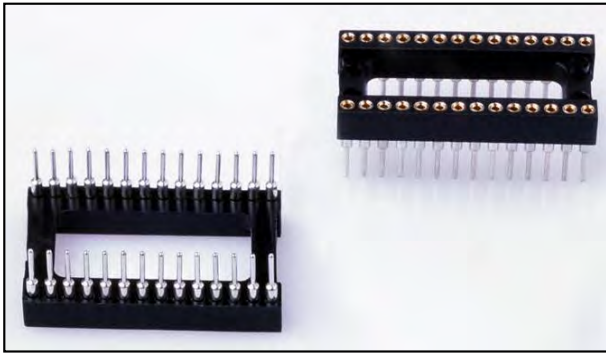

			Pin style	SD
			Plating sleeve (pin)	5.0µm Tin
			Plating contact (clip)	Au 24c flash
A	B	C	NP Nbr PIN	ORDERING NUMBERS
14.6	10.1	7.62	16	723H16.SD.F.0
NP/2 x 1.778	12.6	10.16	28 30 32 48	722HNP.SD.F.0
NP/2 x 1.778	17.7	15.24	20 24 28 40 42 48 52 56 64 68	721HNP.SD.F.0
57.2	21.45	19.05	64	7212H64.SD.F.0
CLOSED FRAME				
57.2	21.45	19.05	64	720H64.SD.F.0
<p>• Options available upon request:</p> <p>1) Surface mount shrinkdip with gull wing terminations Series 721HNP.CL.F.0</p> <p>2) Shrinkdip pin header, solder tail Series 721HNP.MC.F.0</p>				

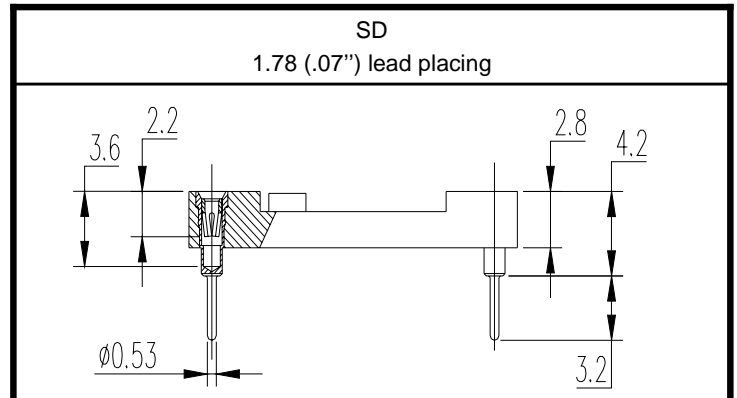

TECHNICAL DATA	
<b>Temperature range</b>	-55°C to +125°C
<b>Insulator body</b>	Glass filled thermoplastic polyester, self-extinguishing, rated UL94V-0 PCT = high temperature (order with H)
<b>Outer shell (sleeve)</b>	Screw machined Brass CuZn36Pb3 (C36000)
<b>Inner spring contact SC4</b>	Stamped and formed BeCu (C17200) gold or tin plated, accepts Ø0.40-0.56 or rectangular pin 0.25 x 0.45
<b>Insertion / Extraction</b>	Ø0.43 test pin



  

Standard SC4	
Insertion	320g max.
Extraction	50g min.

PLATING OPTIONS	
Sleeve (pin), change letter F (5.0µm standard Tin) by:	
➤ .C	0.25µm gold plating
➤ .O	gold flash
➤ .D	tin / lead non-RoHS
Contact (clip), change suffix 0 (standard Au 24c flash) by:	
➤ .1	0.25µm average Au
➤ .4	0.75µm minimum 24c Au (MIL STD)
➤ .6	5.0µm tin
➤ .00	5.0µm tin / lead non-RoHS

ELECTRICAL DATA	
<b>Rated current</b>	1A
<b>Maxi working voltage</b>	100V <sub>RMS</sub> / 150 V <sub>dc</sub>
<b>Contact resistance</b>	10 mΩ max
<b>Dielectric strength</b>	1000 V <sub>RMS</sub> min

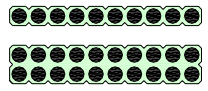
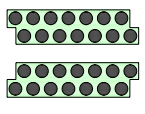
SIP

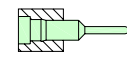
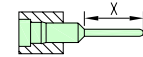
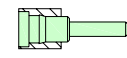
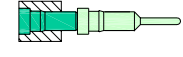
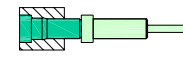
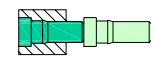
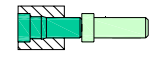
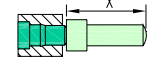
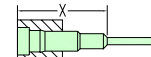
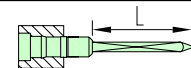
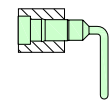
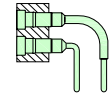
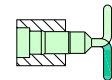
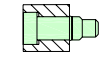
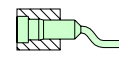
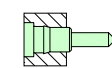
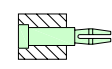
<div style="display: flex; align-items: center;"> <div style="writing-mode: vertical-rl; transform: rotate(180deg); font-weight: bold; margin-right: 5px;">SOCKETS</div> <div style="border: 1px solid black; padding: 5px;"> <div style="display: flex; justify-content: space-between;"> <div style="width: 20%;"></div> <div style="width: 20%; text-align: center;"><b>SERIES</b></div> <div style="width: 20%; text-align: center;">2002 / 2022 2.54mm pitch / 5.08 / 7.62 or other on request</div> <div style="width: 20%; text-align: center;">2022.ZZ 2.54mm pitch / Solder Zig-Zag</div> <div style="width: 20%; text-align: center;">2502 2.54mm pitch / Ultra low profile</div> </div> <div style="display: flex; justify-content: space-around; margin-top: 10px;"> <div style="text-align: center;">  <p>SP</p> </div> <div style="text-align: center;">  </div> <div style="text-align: center;">  </div> <div style="text-align: center;">  </div> </div> </div> </div>				
		CC		30-31
CJ / CM		30-31		
LV		30-31		
CC.CC		39		
CC.CK		39		
CC.CCWT		39		
CC.CKWT		39		
CN.SWU / CN.SWT		39		
LC		32		
AB / BB / AA / BA		30-31		
CL		30-31		
CLS		30-31		
CC.SMV		33		
CCST <i>floating</i>		33		
CC.SMH		33		
LT				41
CCPF		Upon request		

SIP

SP	SERIES	2002 / 2022	2502
		2.54mm pitch / 5.08 / 7.62 or other on request	2.54mm pitch / Ultra low profile
	RR / SS		
	XX / LL / MM		
	FF / JJ / KK		
	TC / WT / WU		
	TT / TU		
	MC / MCS		41
	PB		
	ML		
	MLS		
HEADERS	PMH / PMHS PMH7 / PMHH		
	PMH.F.L		
	PMH.SMV / PMHS.SMV		
	PMH.SMH / PMH.SMHP		
	TU.SMV		
	TU.SMH / TU.SMHP		
	PMHST / PMHSST <i>floating</i>		
	TUST <i>floating</i>		
	SC		
	SL		

# SIP

		SERIES	2004 / 2044	4002 / 4022 / 4042 / 4222	2006	2700	2800	
			2mm pitch	1.27mm pitch	1mm pitch	Shrinksip 1.778mm	Shrinksip 1.8mm	
SOCKETS		SP						
		NC / NB		44				
HEADERS		LV		44				
		SD					42	43
		LC					42	
		NDL		44				
		NDLS		44				
		ND.SMV		46				
		ND.SMH		46				
		FH.SMV			47			
		FH.SMH / FH.SMHS			49	54 Only FH.SMH		
		FH			50	54		
		FH.F.L			51			
		MC					42	
		MD		45				
MDL		45						
MDLS		45						
MD.SMV		46						
MD.SMH		46						
MH.SMV			48					
MH.SMH / MH.SMHP / MH.SMHS			49	54 Only MH.SMH				
MH			52	54				
MH.C.L			53					
SL / SO / SLS / SOS		57						
SC / SB		57						



## Standard SIP

2002 . NP . SP . F . 0 . LP

Series.  
For insulator without center bar  
replace 0 by 1 at the serie n° end.

.	Standard
A	Automatic (Only with pin CC)
H	High temperature insulator
HA	High temperature Automatic ass.

Number of pins

Type of contacts

.=standard

For pitch x2, x3,x4, or other pitch:

Example: 2002H20.CL4F.0 (2.54X4=10.16)

Available with Positioning options (see GUIDE AND PAD description page 29)

Length code  
(only for series for those is needed)

Clip plating option

.	Standard on catalog page
A	SC4
B	SC6.VLI
C	SC6.065
?	Etc.

Pin plating option

## Custom SIP

2002 . NP / 16 . SP . F . 0 . LP

Series  
For insulator without center bar  
replace 0 by 1 at the serie n°

.	Standard
A	Automatic (Only with pin CC)
H	High temperature
HA	High temperature Automatic

Number of pins

/ = first version, B,C,... next versions

Number of positions

2022.8/16.CC.F.0

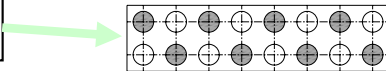

Type of contacts

Length code  
(only for series for those is needed)

Clip plating option

.	Standard on catalog page
A	SC4
B	SC6.VLI
?	Etc.

Pin plating option

.=standard

For pitch x2, x3,x4, or other pitch:

Example: 2002H20/16.LT2F.0 (2.54X2=5.08)

Available with Positioning options (see GUIDE AND PAD description page 29)

To order a special SIP

Customer			
Address			
ZIP	City		
Country			
Phone			
Fax			
E-mail			

## SIP

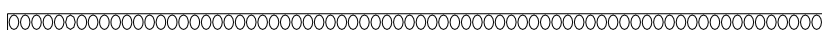
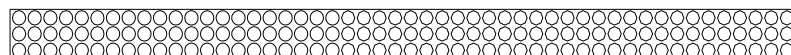

Series	
Type of construction	
Number of pins	
Number of positions	
Type of contact (can be yours)	
Pin plating option	
Type of clip (can be yours)	
Clip plating option	
Length code (if requested)	

Fill in the holes where you want the contacts. If your request isn't standard, please send us a detailed drawing. For the very specific design, insulator is made in Epoxy.

# Guide and Pad option

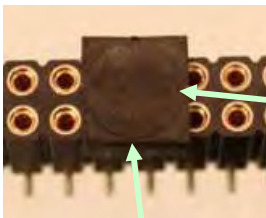
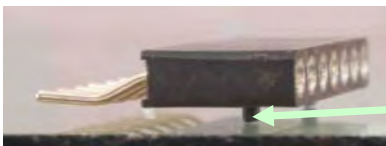
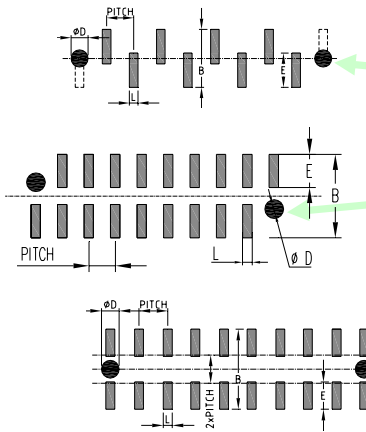

## PACKAGING OPTIONS

Box	Standard Example: 4002HNP.FH.SMV.F.0
Tape & Reel	Change the dash after NP into B Example: 4002HNPPBFH.SMV.F.0
Tube	Change the dash after NP into T Example: 4002HNPTFH.SMV.F.0
Tray	Change the dash after NP into R Example: 4002HNPRFH.SMV.F.0

Please consult customer service for availability

## POSITIONING CONTACT

For single row, the first and the last pin are not bent (positioning guide) but counted as contacts.

Series 2001, 4001, 2002, 4002, etc

For double row, the first and the last pin are not bent (positioning guide) but counted as contacts.

Series 2011, 4011, 2022, 4022, etc

## POSITIONING PIN

For double rows (2x pitch), the guides are not counted as contacts.

Guide Series 4042 in surface mount version.

Other series with these options upon request.

Add letter P before NP

Example: 4002HPNP.FH.SMV.F.0

## POSITIONING PEGS

Available for serie 2001, version PFH.SMH

## PICK & PLACE

Pad Place letter P between Np and B (or T or SP)

Example: 4002HNPPBFH.SMV.F.0

For pick and place function, a pad is added in the middle of the socket.

Dimensions	Length	Width
Serie 2001	6.5 10	5 5
Serie 2011	6	6
Serie 4002	6.02	4.4
Serie 4022	7.97	4.4
Serie 4042	7.97	4.4

CL		CLS		CC / CJ / CM			
2002		2022		2002		2022	
Mating pin 0.47mm				Mating pin stand 0.47mm / 0.76 (only straight version) SIP IC sockets			
				<b>SP</b>	<b>CC</b>	<b>CJ</b>	<b>CM</b>
				PIN LENGTH X	2.9mm	4.1mm	7mm

LV		AA / AB / BA / BB						
2002		2022		2002		2022		
Very low profile SIP sockets				Wire-wrap				
				<b>SP</b>	<b>AA</b>	<b>AB</b>	<b>BA</b>	<b>BB</b>
				PIN LENGTH X	12.95mm	6.6mm	16.0mm	9.4mm

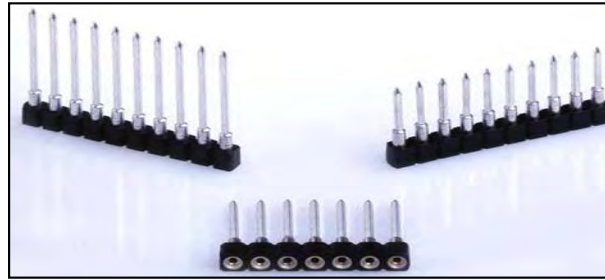
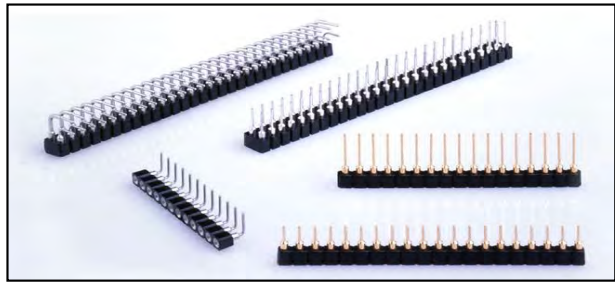
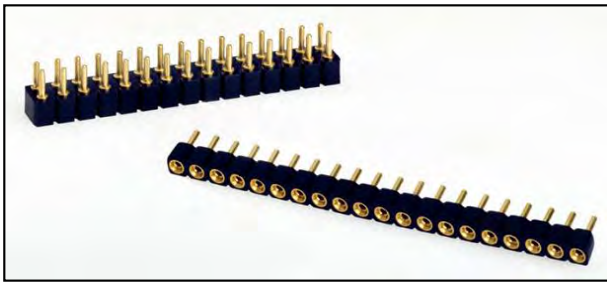

Pin style		CC / CJ / CM / CL / CLS / LV / AA / AB / BA / BB
Plating sleeve (pin)		5.0µm Tin
Plating contact (clip)		Au 24c flash
TYPE	NP Nbr PIN	ORDERING NUMBERS
2002	20 32 64 (*1)	2002.NP.SP.F.0
2022	64 72 (*2)	2022.NP.SP.F.0
*1) Availability from 1 to 64 contacts		
*2) Availability from 2 to 72 contacts		

PLATING OPTIONS	
Sleeve (pin), change letter F (5.0µm standard Tin) by:	
➤ .C	0.25µm gold plating
➤ .O	gold flash
➤ .D	tin / lead non-RoHS
Contact (clip), change suffix 0 (standard Au 24c flash) by:	
➤ .1	0.25µm average Au
➤ .2	0.50µm average Au
➤ .3	0.75µm average Au
➤ .4	0.75µm minimum 24c Au (MIL STD)
➤ .6	5.0µm tin
➤ .00	5.0µm tin / lead non-RoHS

TECHNICAL DATA			
<b>Temperature range</b>	-55°C to +125°C		
<b>Insulator body</b>	Glass filled thermoplastic polyester, self-extinguishing, rated UL94V-0 PCB = standard PCT = high temperature (order with H) Example: 2002H28.CL.F.0		
<b>Outer shell (sleeve)</b>	Screw machined Brass CuZn36Pb3 (C36000)		
<b>Inner spring contact SC4</b>	Stamped and formed BeCu (C17200) gold or tin plated, accepts Ø0.40-0.56 or rectangular pin 0.25 x 0.45		
<b>Insertion / Extraction</b>	Ø0.43 test pin Other forces available upon request.		
Standard SC4		SC6.VLI	
Insertion	320g max.	Insertion	70g max.
Extraction	50g min.	Extraction	10g min.
To order with inner spring type SC6.VLI, add letter B after F instead of the mark. Example: 2002.20.CC.FB0			
<b>Other mating pin available upon request</b>			
To order with inner spring type SC6.065 (insertion Ø0.65-0.85), add letter C after F instead of the mark. Example: 2002.40.CC.FC0 (only right version)			
ELECTRICAL DATA			
<b>Rated current</b>	3A		
<b>Maxi working voltage</b>	100V <sub>RMS</sub> / 150 V <sub>dc</sub>		
<b>Contact resistance</b>	10 mΩ max		
<b>Dielectric strength</b>	1000 V <sub>RMS</sub> min		

SIP 2.54mm pitch / Sockets / Solder tail /  
Mating pin 0.47mm / Breakable / Elevated pin

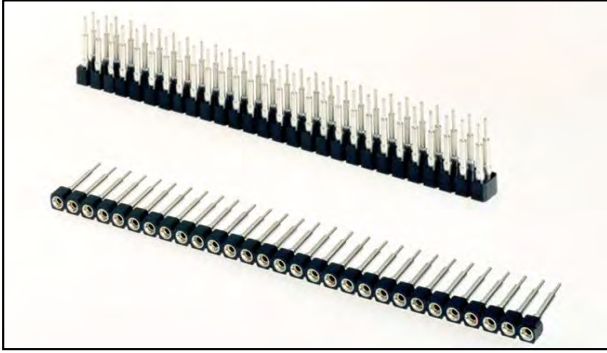

<p>NO OF CONTACT x 2.54</p> <p>2.54</p>	Pin style	LC
	Plating sleeve (pin)	5.0µm Tin
	Plating contact (clip)	Au 24c flash
TYPE	NP Nbr PIN	ORDERING NUMBERS
2002	20 32 64 (*1)	2002.NP.LC.F.0.LP
2022	64 72 (*2)	2022.NP.LC.F.0.LP
*1) Availability from 1 to 64 contacts		
*2) Availability from 2 to 72 contacts		

LP PIN LENGTH X (in mm) Other pin length X upon request					
5.6	6.0	7.0	8.0	9.0	10.2
12.0	13.5	15.1	16.3	18.0	22.0
29.0	33.0	35.0			

PLATING OPTIONS	
Sleeve (pin), change letter F (5.0µm standard Tin) by:	
➤ .C	0.25µm gold plating
➤ .O	gold flash
➤ .D	tin / lead non-RoHS
Contact (clip), change suffix 0 (standard Au 24c flash) by:	
➤ .1	0.25µm average Au
➤ .2	0.50µm average Au
➤ .3	0.75µm average Au
➤ .4	0.75µm minimum 24c Au (MIL STD)
➤ .6	5.0µm tin
➤ .00	5.0µm tin / lead non-RoHS

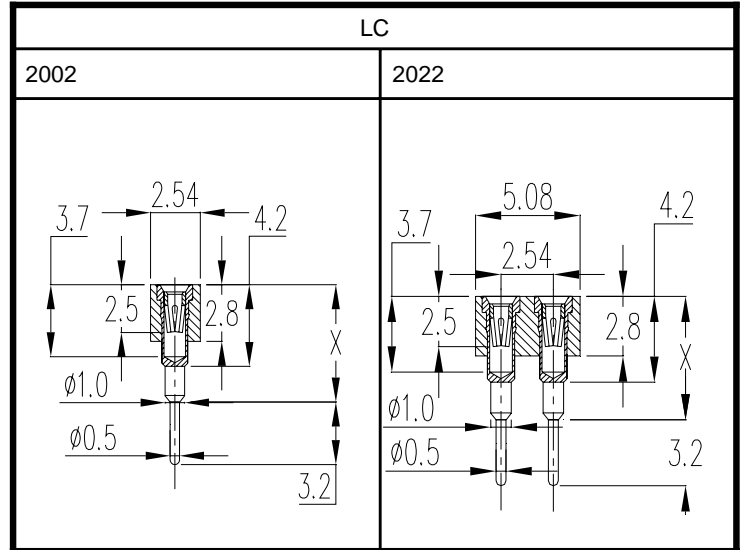

TECHNICAL DATA			
<b>Temperature range</b>	-55°C to +125°C		
<b>Insulator body</b>	Glass filled thermoplastic polyester, self-extinguishing, rated UL94V-0 PCB = standard PCT = high temperature (order with H) Example: 2022H28.LC.F.0.8.0		
<b>Outer shell (sleeve)</b>	Screw machined Brass CuZn36Pb3 (C36000)		
<b>Inner spring contact SC4</b>	Stamped and formed BeCu (C17200) gold or tin plated, accepts Ø0.40-0.56 or rectangular pin 0.25 x 0.45		
<b>Insertion / Extraction</b>	Ø0.43 test pin Other forces available upon request.		
	Standard SC4	SC6.VLI	
Insertion	320g max.	Insertion	70g max.
Extraction	50g min.	Extraction	10g min.
To order with inner spring type SC6.VLI, add letter B after F instead of the mark. Example: 2002H14.LC.FB0.6.0			

ELECTRICAL DATA	
<b>Rated current</b>	3A
<b>Maxi working voltage</b>	100V <sub>RMS</sub> / 150 V <sub>dc</sub>
<b>Contact resistance</b>	10 mΩ max
<b>Dielectric strength</b>	1000 V <sub>RMS</sub> min

SIP 2.54mm pitch / Sockets / Gull wing /  
 Floating pin / Mating pin 0.47mm / Breakable /  
 Surface mount



CC.SMH		CCST		CC.SMV	
2002		2002	2022	2002	2022
For Pick and Place, see Series 4001 PMH.SMHP		PCB Board $\phi$ 1.5			
		Floating pin			

Pin style		CC.SMH / CCST / CC.SMV
Plating sleeve (pin)		5.0 $\mu$ m Tin
Plating contact (clip)		Au 24c flash
TYPE	NP Nbr PIN	ORDERING NUMBERS
2002	20 32 64 (*1)	2002HNP.SP.F
2022	64 72 (*2)	2022.NP.SP.F
*1) Available from: 3 to 64 contacts		
*2) Available from: 4 to 72 contacts		

PLATING OPTIONS	
Sleeve (pin), change letter F (5.0 $\mu$ m standard Tin) by:	
➤ .C	0.25 $\mu$ m gold plating
➤ .O	gold flash
➤ .D	tin / lead non-RoHS

Contact (clip), change suffix 0 (standard Au 24c flash) by:	
➤ .1	0.25 $\mu$ m average Au
➤ .2	0.50 $\mu$ m average Au
➤ .3	0.75 $\mu$ m average Au
➤ .4	0.75 $\mu$ m minimum 24c Au (MIL STD)
➤ .6	5.0 $\mu$ m tin
➤ .00	5.0 $\mu$ m tin / lead non-RoHS

• Other height available: 7mm instead of 5.6mm  
 Please contact the customer service.

Available with Positioning options  
 (see GUIDE AND PAD description page 29)

TECHNICAL DATA							
<b>Temperature range</b>	-55°C to +125°C						
<b>Insulator body</b>	Glass filled thermoplastic polyester, self-extinguishing, rated UL94V-0 PCT = high temperature						
<b>Outer shell (sleeve)</b>	Screw machined Brass CuZn36Pb3 (C36000)						
<b>Inner spring contact SC4</b>	Stamped and formed BeCu (C17200) gold or tin plated, accepts $\phi$ 0.40-0.56 or rectangular pin 0.25 x 0.45						
<b>Insertion / Extraction</b>	$\phi$ 0.43 test pin Other forces available upon request.						
<table border="1"> <thead> <tr> <th colspan="2">Standard SC4</th> </tr> </thead> <tbody> <tr> <td>Insertion</td> <td>320g max.</td> </tr> <tr> <td>Extraction</td> <td>50g min.</td> </tr> </tbody> </table>		Standard SC4		Insertion	320g max.	Extraction	50g min.
Standard SC4							
Insertion	320g max.						
Extraction	50g min.						

ELECTRICAL DATA	
<b>Rated current</b>	3A
<b>Maxi working voltage</b>	100V <sub>RMS</sub> / 150 V <sub>dc</sub>
<b>Contact resistance</b>	10 m $\Omega$ max
<b>Dielectric strength</b>	1000 V <sub>RMS</sub> min



SIP 2.54mm pitch / Headers / Solder tail /  
Wire-wrap / Connecting pin 0.47mm / Right angle /  
Breakable / Turret and slotted head / Strip /  
Solder cup / Piggy-back

TC / WT / WU		FF / JJ / KK	
2002	2022	2002	2022
TT / TU		PB	
2002	2022	2002	2022
XX / LL / MM		RR / SS	
2002	2022	2002	2022
ML / MLS		MC	
2002	2022	2002	2022

## SERIES 2002,2022

SIP 2.54mm pitch / Headers / Solder tail / Wire-wrap / Connecting pin 0.47mm / Right angle / Breakable / Turret and slotted head / Strip / Solder cup / Piggy-back

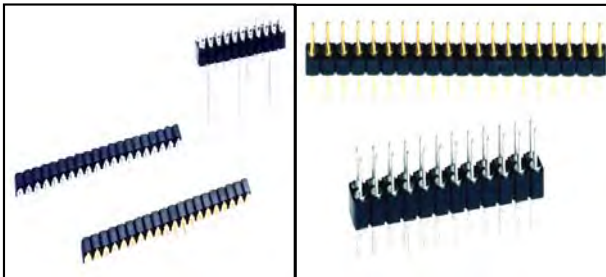
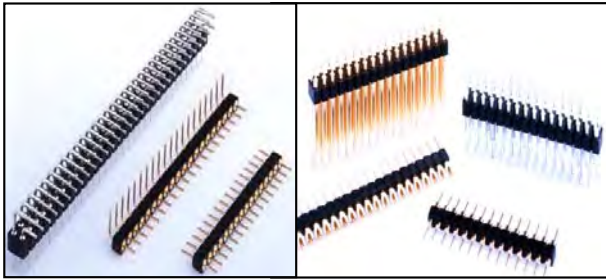

Pin style		TC / WT / WU / FF / JJ / KK / TT / TU / XX / LL / MM / RR / SS
Plating sleeve (pin)		5.0µm Tin
		For FF / JJ / KK: 5.0 µm Sn Tin / Lead
Plating contact (clip)		Au 24c flash
TYPE	NP Nbr PIN	ORDERING NUMBERS
2002	20 32 60 64 (*1)	2002HNP.SP.F
2022	64 72 (*2)	2022HNP.SP.F
*1) Availability from 1 to 64 contacts		
*2) Availability from 2 to 72 contacts		

mm	X	Y	Z
SP			
TC	3.9	Ø 0.5	-
WT	12.95	Sq 0.635	-
WU	6.4	Sq 0.635	-
FF	3.9	Ø 0.5	-
JJ	12.95	Sq 0.635	-
KK	9.4	Sq 0.635	-
TT	4.2	Ø 0.64	4.8
TU	3.7	Ø 0.5	4.3
PB	6.4 / 8.4 / 15.4 / 21.2 / 27.4	-	-
XX	3.9	Ø 0.5	-
LL	12.95	Sq 0.635	-
MM	9.4	Sq 0.635	-
RR	12.95	-	-
SS	9.4	-	-

### PLATING OPTIONS

Sleeve (pin), change letter F (5.0µm standard Tin) by:

- .C 0.25µm gold plating
- .O gold flash
- .D tin / lead non-RoHS
- .S 0.25µm gold plating (connecting side)  
5µm tin (PCB side)
- .S only available for TU style

### TECHNICAL DATA

**Temperature range** -55°C to +125°C

**Insulator body** Glass filled thermoplastic polyester, self-extinguishing, rated UL94V-0  
PCB = standard  
PCT = high temperature (order with H)  
Example: 2002H28.TT.F

**Outer shell (sleeve)** Screw machined Brass CuZn36Pb3 (C36000)

To order PB type, please add length X after the gold plating code  
Example: 2002.24.PB.F.8.4

### ELECTRICAL DATA

**Rated current** 3A

**Maxi working voltage** 100V<sub>RMS</sub> / 150 V<sub>dc</sub>

**Contact resistance** 10 mΩ max

**Dielectric strength** 1000 V<sub>RMS</sub> min

SIP 2.54mm pitch / Headers / Solder tail /  
Connecting pin 0.76mm

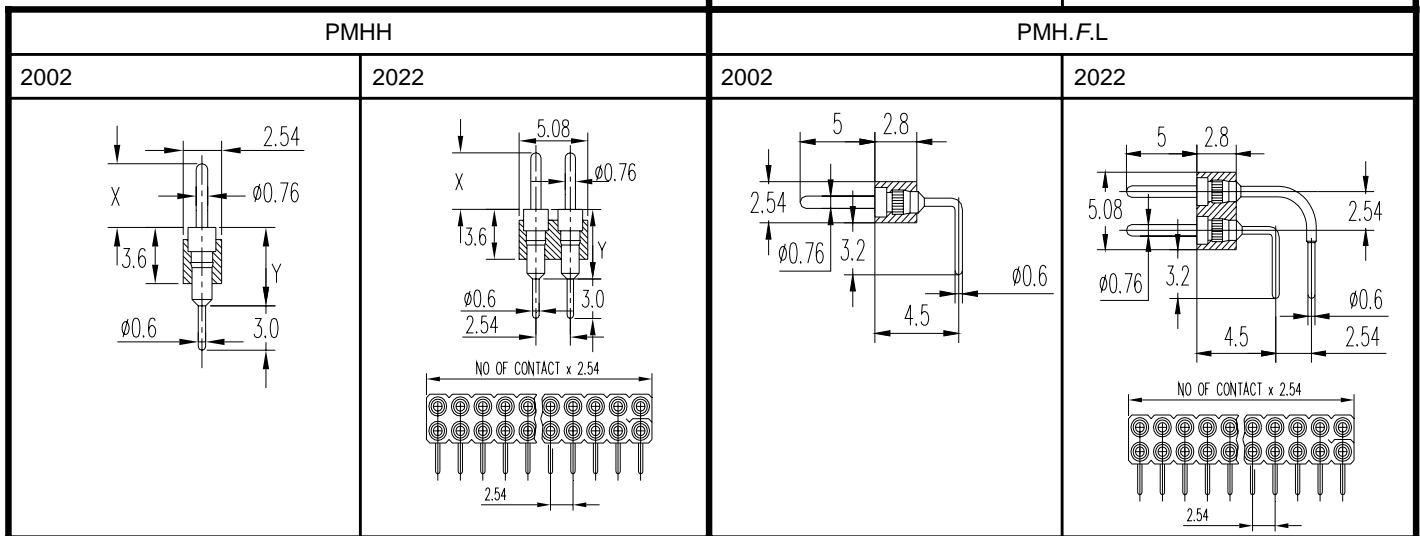
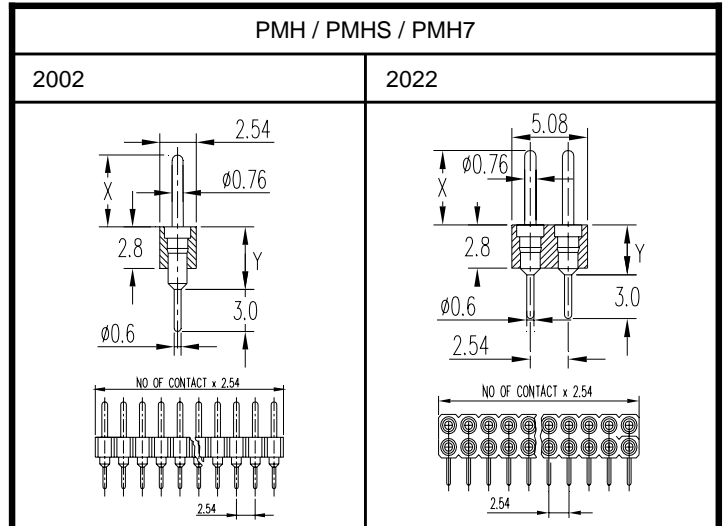
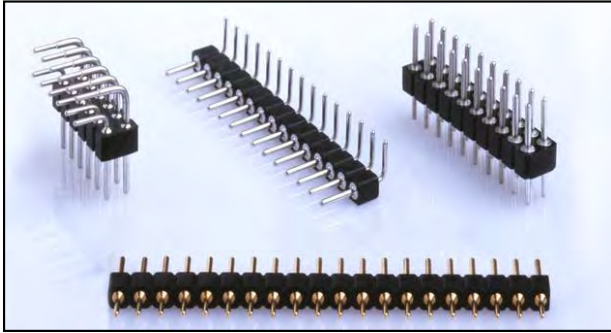

Pin style		PMH / PMHS / PMH7 / PMHH / PMH.F.L
Plating sleeve (pin)		5.0µm Tin
TYPE	NP Nbr PIN	ORDERING NUMBERS
2002	20 32 64 (*1)	2002.NP.SP.F
2022	64 72 (*2)	2022.NP.SP.F
2002	20 32 64 (*1)	2002.NP.PMH.F.L
2022	64 72 (*2)	2022.NP.PMH.F.L

\*1) Availability from 1 to 64 contacts

\*2) Availability from 2 to 72 contacts

SP	mm	X	Y
PMHS		3.6	3.2
PMH		5.0	3.2
PMHH		4.3	4.76 (=0.8+2.8+1.16)
PMH7		7	3.2

## TECHNICAL DATA

<b>Temperature range</b>	-55°C to +125°C
<b>Insulator body</b>	Glass filled thermoplastic polyester, self-extinguishing, rated UL94V-0 PCB = standard PCT = high temperature (order with H) Example: 2002H32.PMH.F
<b>Outer shell (sleeve)</b>	Screw machined Brass CuZn36Pb3 (C36000)

## ELECTRICAL DATA

<b>Rated current</b>	3A
<b>Maxi working voltage</b>	100V <sub>RMS</sub> / 150 V <sub>dc</sub>
<b>Contact resistance</b>	10 mΩ max
<b>Dielectric strength</b>	1000 V <sub>RMS</sub> min

## PLATING OPTIONS

Sleeve (pin), change letter F (5.0µm standard Tin) by:

- .C 0.25µm gold plating
- .O gold flash
- .D tin / lead non-RoHS
- .S 0.25µm gold plating (connecting side)  
5µm tin (PCB side)
- .S only available for PMH, PMHS and PMH7 style

SIP 2.54mm pitch / Headers / Gull wing /  
Floating pin / Connecting pin 0.76mm /  
Surface mount

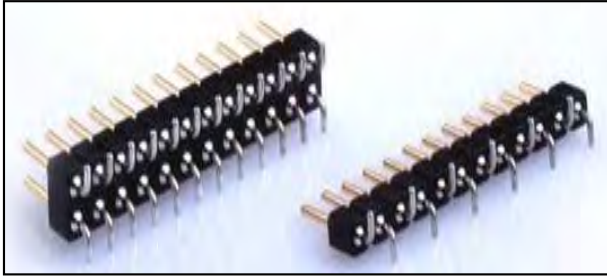

PMH.SMV / PMHS.SMV		PMH.SMH	PMHST / PMHSST
2002	2022	2002	2002      2022

SP	PMHST	PMHSST
PIN LENGTH X	5.0mm	3.6mm

PMH.SMHP
4001 (Pick and place)

\* You can get a 2.8mm instead of a 3.8mm one for the single row version by ordering 2502H....

Pin style		PMH.SMV / PMHS.SMV / PMH.SMH / PMH.SMHP / PMHST / PMHSST
Plating sleeve (pin)		5.0µm Tin
TYPE	NP Nbr PIN	ORDERING NUMBERS
2002	20 32 60 64 (*1)	2002HNP.SP.F
2022	40 44 56 64 72 (*2)	2022HNP.SP.F
2002	20 32 60 64 (*3)	2002HNP.SP.F
4001	48 (*4)	4001HNP.SP.F

- \*1) Available from: 3 to 64 contacts
- \*2) Available from: 4 to 72 contacts
- \*3) Available from: 2 to 64 contacts
- \*4) Available from: 1 to 48 contacts

Available with Positioning options  
(see GUIDE AND PAD description page 29)

PLATING OPTIONS	
Sleeve (pin), change letter F (5.0µm standard Tin) by:	
➤ .C	0.25µm gold plating
➤ .O	gold flash
➤ .D	tin / lead non-RoHS
➤ .S	0.25µm gold plating (connecting side) 5µm tin (PCB side)

TECHNICAL DATA	
Temperature range	-55°C to +125°C
Insulator body	Glass filled thermoplastic polyester, self-extinguishing, rated UL94V-0 PCT = high temperature (order with H) Example: 2002H32.PMH.SMV.F
Outer shell (sleeve)	Screw machined Brass CuZn36Pb3 (C36000)

ELECTRICAL DATA	
Rated current	3A
Maxi working voltage	100V <sub>RMS</sub> / 150 V <sub>dc</sub>
Contact resistance	10 mΩ max
Dielectric strength	1000 V <sub>RMS</sub> min

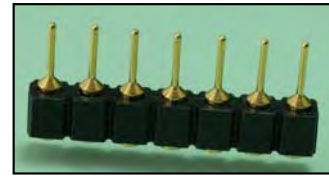
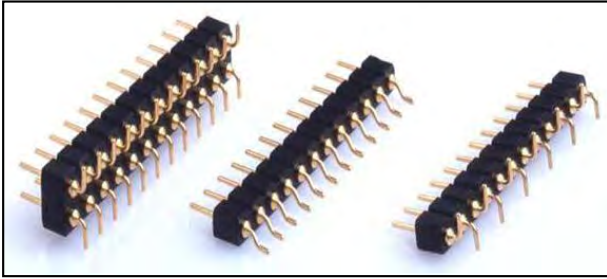

TU.SMV		TU.SMH	TU.SMHP	TUST
2002	2022	2002	2002	2022

Available with Positioning options  
(see GUIDE AND PAD description page 29)

Pin style		TU.SMV / TU.SMH / TU.SMHP / TUST
Plating sleeve (pin)		5.0µm Tin
TYPE	NP Nbr PIN	ORDERING NUMBERS
2002	20 32 60 64 (*1)	2002HNP.SP.F
2022	40 44 56 64 72 (*2)	2022.NP.SP.F
2002	20 32 60 64 (*3)	2002.NP.SP.F
4001	48 (*4)	4001HNP.SP.F

\*1) Available from: 3 to 64 contacts  
\*2) Available from: 4 to 72 contacts  
\*3) Available from: 1 to 64 contacts  
\*4) Available from: 1 to 48 contacts

### PLATING OPTIONS

Sleeve (pin), change letter F (5.0µm standard Tin) by:

- .C 0.25µm gold plating
- .O gold flash
- .D tin / lead non-RoHS
- .S 0.25µm gold plating (connecting side)  
5µm tin (PCB side)

### TU.SMHP

4001 (Pick and place)

\* You can get a 3mm instead of a 4mm one for the single row version by ordering 2502H....

### TECHNICAL DATA

Temperature range	-55°C to +125°C
Insulator body	Glass filled thermoplastic polyester, self-extinguishing, rated UL94V-0 PCT = high temperature
Outer shell (sleeve)	Screw machined Brass CuZn36Pb3 (C36000)

### ELECTRICAL DATA

Rated current	3A
Maxi working voltage	100V <sub>RMS</sub> / 150 V <sub>dc</sub>
Contact resistance	10 mΩ max
Dielectric strength	1000 V <sub>RMS</sub> min



SIP 2.54mm pitch / Sockets / Solder tail /  
Mating pin 0.47mm / Surface mount /  
Plastic carrier



CC.CC		CC.CK		CC.CCWT		CC.CKWT		CN.SWT / CN.SWU	
2002	2022	2002	2022	2002	2022	2002	2022	2002	2022

Pin style		CC.CC / CC.CK / CC.CCWT / CC.CKWT / CN.SWT / CN.SWU
Plating sleeve (pin)		5.0µm Tin
Plating contact (clip)		Au 24c flash
TYPE	NP Nbr PIN	ORDERING NUMBERS
2002	20 32 64 (*1)	2002HNP.SP.F
2022	64 72 (*2)	2022.NP.SP.F
*1) Availability from 1 to 64 contacts		
*2) Availability from 2 to 72 contacts		

SP	CN.SWT	CN.SWU
PIN LENGTH X	3.6mm	6.3mm
PIN LENGTH Y	3.2mm	5.9mm

TECHNICAL DATA	
<b>Temperature range</b>	-55°C to +125°C
<b>Insulator body</b>	Glass filled thermoplastic polyester, self-extinguishing, rated UL94V-0 PCB = standard PCT = high temperature (order with H) Example: 2022H28.CC.CK.F.0
<b>Outer shell (sleeve)</b>	Screw machined Brass CuZn36Pb3 (C36000)
<b>Inner spring contact SC4</b>	Stamped and formed BeCu (C17200) gold or tin plated, accepts Ø0.40-0.56 or rectangular pin 0.25 x 0.45
<b>Insertion / Extraction</b>	Ø0.43 test pin Other forces available upon request.

PLATING OPTIONS	
Sleeve (pin), change letter F (5.0µm standard Tin) by:	
➤ .C	0.25µm gold plating
➤ .O	gold flash
➤ .D	tin / lead non-RoHS
Contact (clip), change suffix 0 (standard Au 24c flash) by:	
➤ .1	0.25µm average Au
➤ .2	0.50µm average Au
➤ .3	0.75µm average Au
➤ .4	0.75µm minimum 24c Au (MIL STD)
➤ .6	5.0µm tin
➤ .00	5.0µm tin / lead non-RoHS

Standard SC4		SC6.VLI	
Insertion	320g max.	Insertion	70g max.
Extraction	50g min.	Extraction	10g min.

To order with inner spring type SC6.VLI, add letter B after F instead of the mark.

Example: 2022.32.CC.CK.FB0

ELECTRICAL DATA	
<b>Rated current</b>	3A
<b>Maxi working voltage</b>	100V <sub>RMS</sub> / 150 V <sub>dc</sub>
<b>Contact resistance</b>	10 mΩ max
<b>Dielectric strength</b>	1000 V <sub>RMS</sub> min



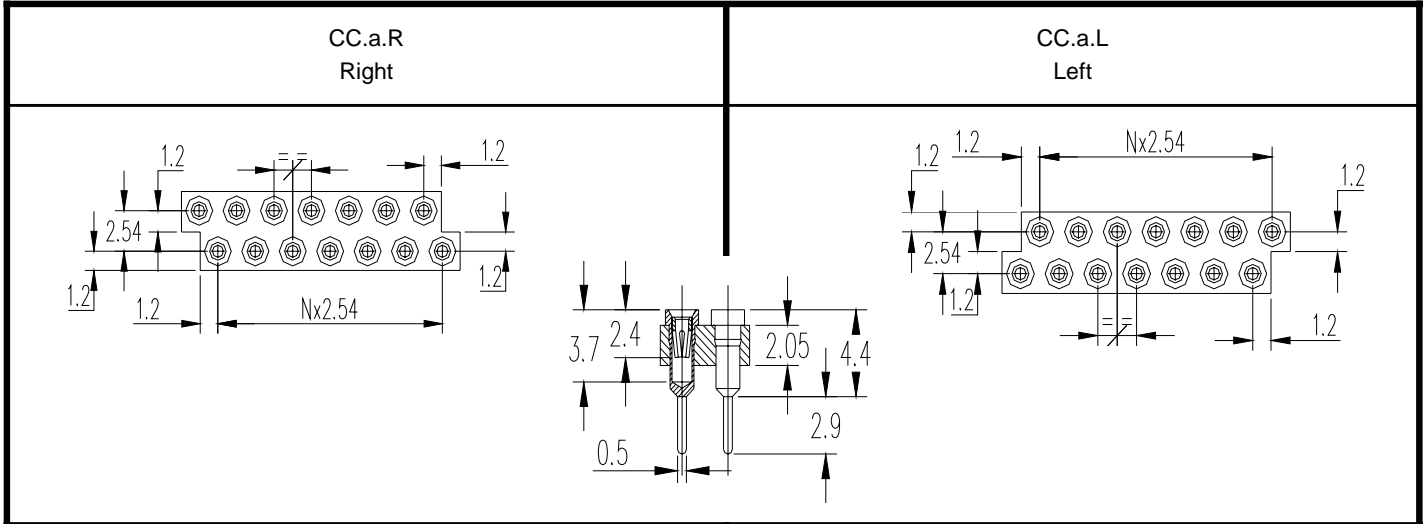
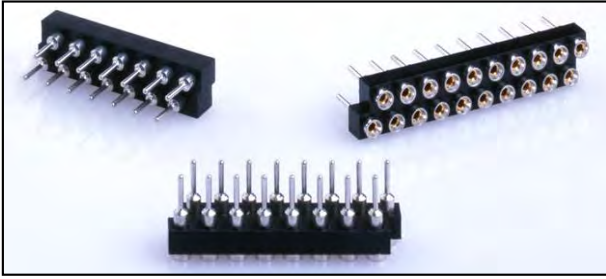

Pin style		CC.a.R / CC.a.L
Plating sleeve (pin)		5.0µm Tin
Plating contact (clip)		Au 24c flash
TYPE	NP Nbr PIN	ORDERING NUMBERS
2022	14* 16 20 24 28 30 40	2022.ZZ.NP.CC.F.0.R 2022.ZZ.NP.CC.F.0.L
	14* : pin strips are not stackable end to end	
Pin CC can be changed by all pins suitable for series 2002 and 2022 in straight version.		

### PLATING OPTIONS

Sleeve (pin), change letter F (5.0µm standard Tin) by:

- .C 0.25µm gold plating
- .O gold flash
- .D tin / lead non-RoHS

Contact (clip), change suffix 0 (standard Au 24c flash) by:

- .1 0.25µm average Au
- .2 0.50µm average Au
- .3 0.75µm average Au
- .4 0.75µm minimum 24c Au (MIL STD)
- .6 5.0µm tin
- .00 5.0µm tin / lead non-RoHS

### TECHNICAL DATA

**Temperature range** -55°C to +125°C

**Insulator body** Glass filled thermoplastic polyester, self-extinguishing, rated UL94V-0  
PCB = standard  
PCT = high temperature (order with H)  
Example: 2022.ZZH28.CC.F.0.R

**Outer shell (sleeve)** Screw machined Brass CuZn36Pb3 (C36000)

**Inner spring contact SC4** Stamped and formed BeCu (C17200) gold or tin plated, accepts Ø0.40-0.56 or rectangular pin 0.25 x 0.45

**Insertion / Extraction** Ø0.43 test pin  
Other forces available upon request.

Standard SC4		SC6.VLI	
Insertion	320g max.	Insertion	70g max.
Extraction	50g min.	Extraction	10g min.

To order with inner spring type SC6.VLI, add letter B after F instead of the mark.  
Example: 2022.ZZ.24.CC.FB0.R

### ELECTRICAL DATA

**Rated current** 3A

**Maxi working voltage** 100V<sub>RMS</sub> / 150 V<sub>dc</sub>

**Contact resistance** 10 mΩ max

**Dielectric strength** 1000 V<sub>RMS</sub> min

SIP 2.54mm pitch / Sockets and Headers /  
Solder tail / Mating pin 0.47mm / Ultra low profile /  
Breakable

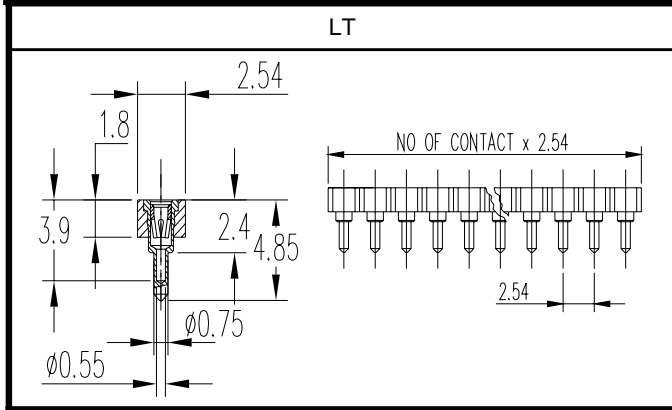
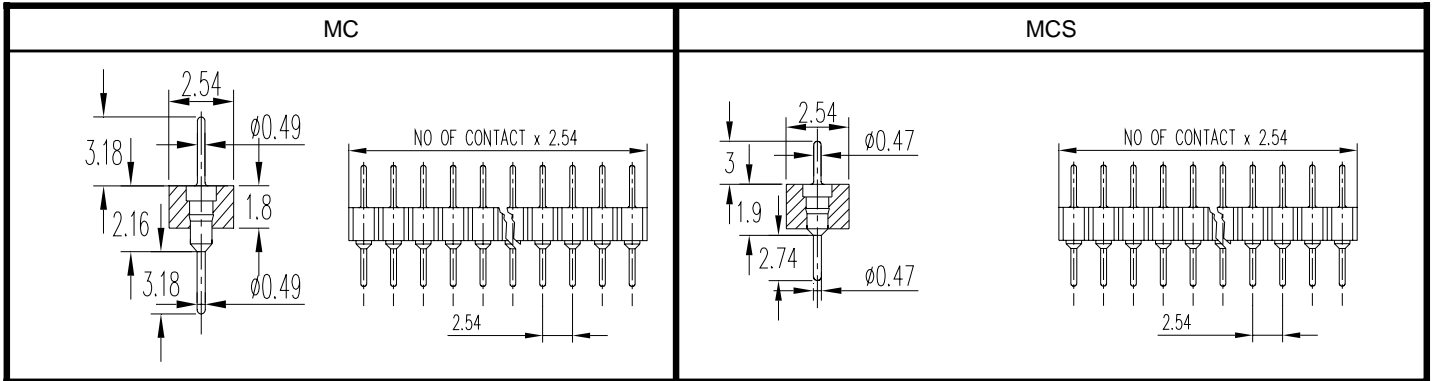
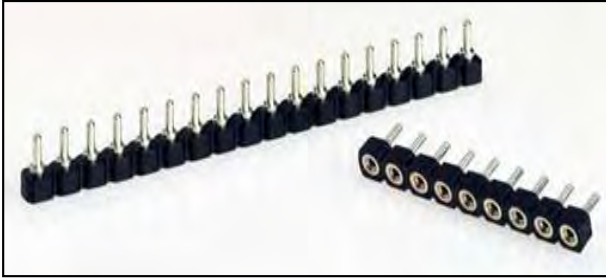

Pin style	LT / MC / MCS	
Plating sleeve (pin)	5.0µm Tin	
Plating contact (clip)	Au 24c flash	
TYPE	NP Nbr PIN	ORDERING NUMBERS
2502	56 64 (*1)	2502.NP.SP.F.0

\*1) Availability from 1 to 64 contacts

## PLATING OPTIONS

Sleeve (pin), change letter F (5.0µm standard Tin) by:

- .C 0.25µm gold plating
- .O gold flash
- .D tin / lead non-RoHS

Contact (clip), change suffix 0 (standard Au 24c flash) by:

- .1 0.25µm average Au
- .2 0.50µm average Au
- .3 0.75µm average Au
- .4 0.75µm minimum 24c Au (MIL STD)
- .6 5.0µm tin
- .00 5.0µm tin / lead non-RoHS

## TECHNICAL DATA

<b>Temperature range</b>	-55°C to +125°C
<b>Insulator body</b>	Glass filled thermoplastic polyester, self-extinguishing, rated UL94V-0 PCB = standard PCT = high temperature (order with H) Example: 2502H64.MC.F.0
<b>Outer shell (sleeve)</b>	Screw machined Brass CuZn36Pb3 (C36000)
<b>Inner spring contact SC4</b>	Stamped and formed BeCu (C17200) gold or tin plated, accepts Ø0.40-0.56 or rectangular pin 0.25 x 0.45
<b>Insertion / Extraction</b>	Ø0.43 test pin Other forces available upon request.

Standard SC4.SH		SC4	
Insertion	350g max.	Insertion	320g max.
Extraction	100g min.	Extraction	50g min.

To order with inner spring type SC4, add letter A after F instead of the mark.

Example: 2502.56.LT.FA0

## ELECTRICAL DATA

<b>Rated current</b>	3A
<b>Maxi working voltage</b>	100V <sub>RMS</sub> / 150 V <sub>dc</sub>
<b>Contact resistance</b>	10 mΩ max
<b>Dielectric strength</b>	1000 V <sub>RMS</sub> min

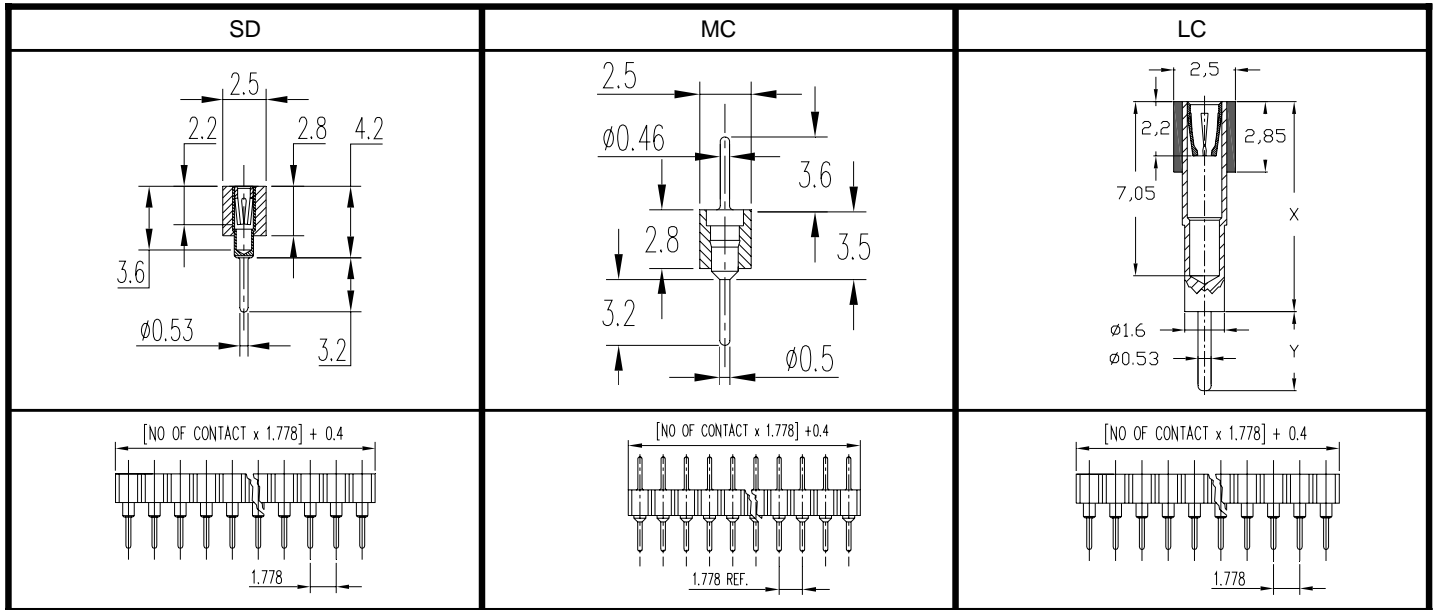
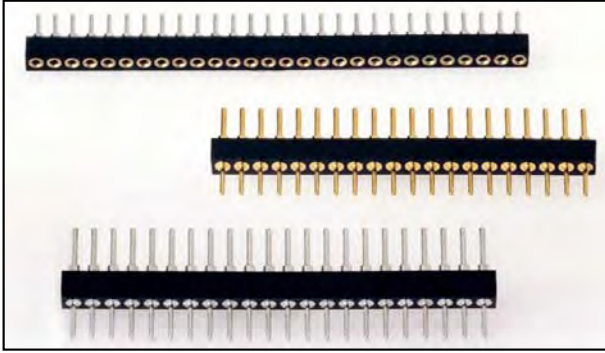

Pin style		SD / MC / LC
Plating sleeve (pin)		5.0µm Tin
Plating contact (clip)		Au 24c flash
TYPE	NP Nbr PIN	ORDERING NUMBERS
SD	21 38 (*1)	2700.NP.SP.F.0
MC	21 38 (*1)	2700.NP.SP.F
LC	21 38 (*1)	2700.NP.SP.F.0.LP
*1) Availability from 1 to 38 contacts		

	SP	LC
PIN LENGTH X	8.5mm	10.0mm
PIN LENGTH Y	3.2mm	4.0mm

### PLATING OPTIONS

Sleeve (pin), change letter F (5.0µm standard Tin) by:

- .C 0.25µm gold plating
- .O gold flash
- .D tin / lead non-RoHS

Contact (clip), change suffix 0 (standard Au 24c flash) by:

- .1 0.25µm average Au
- .4 0.75µm minimum 24c Au (MIL STD)
- .6 5.0µm tin
- .00 5.0µm tin / lead non-RoHS

### TECHNICAL DATA

**Temperature range** -55°C to +125°C

**Insulator body** Glass filled thermoplastic polyester, self-extinguishing, rated UL94V-0  
PCT = high temperature  
Example: 2700H32.SD.F.0

**Outer shell (sleeve)** Screw machined Brass CuZn36Pb3 (C36000)

**Inner spring contact SC4** Stamped and formed BeCu (C17200) gold or tin plated, accepts Ø0.40-0.56 or rectangular pin 0.25 x 0.45

Standard SC4	
Insertion	320g max.
Extraction	50g min.

### ELECTRICAL DATA

<b>Rated current</b>	1A
<b>Maxi working voltage</b>	100V <sub>RMS</sub> / 150 V <sub>dc</sub>
<b>Contact resistance</b>	10 mΩ max
<b>Dielectric strength</b>	1000 V <sub>RMS</sub> min

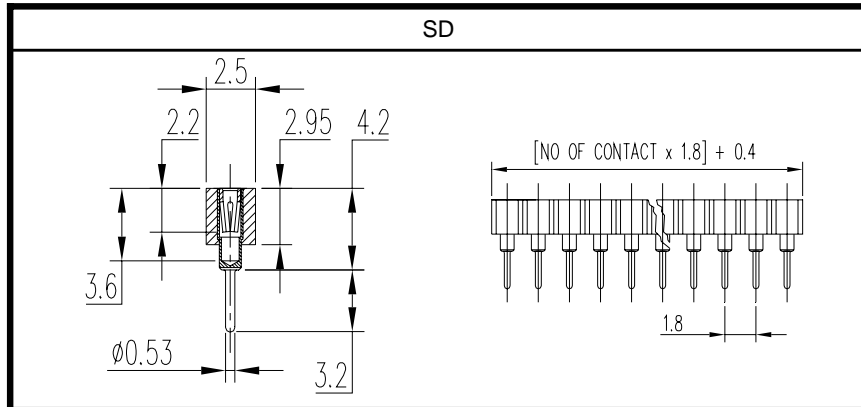
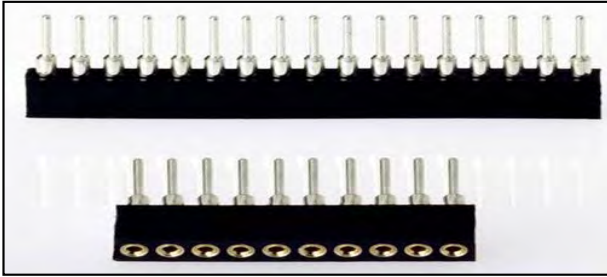

Pin style		SD
Plating sleeve (pin)		5.0µm Tin
Plating contact (clip)		Au 24c flash
TYPE	NP Nbr PIN	ORDERING NUMBERS
2800	42 (*1)	2800.NP.SP.F.0
*1) Availability from 1 to 42 contacts		

PLATING OPTIONS	
Sleeve (pin), change letter F (5.0µm standard Tin) by:	
➤ .C	0.25µm gold plating
➤ .O	gold flash
➤ .D	tin / lead non-RoHS
Contact (clip), change suffix 0 (standard Au 24c flash) by:	
➤ .1	0.25µm average Au
➤ .4	0.75µm minimum 24c Au (MIL STD)
➤ .6	5.0µm tin
➤ .00	5.0µm tin / lead non-RoHS

TECHNICAL DATA							
<b>Temperature range</b>	-55°C to +125°C						
<b>Insulator body</b>	Glass filled thermoplastic polyester, self-extinguishing, rated UL94V-0 PCT = high temperature Example: 2800H32.SD.F.0						
<b>Outer shell (sleeve)</b>	Screw machined Brass CuZn36Pb3 (C36000)						
<b>Inner spring contact SC4</b>	Stamped and formed BeCu (C17200) gold or tin plated, accepts Ø0.40-0.56 or rectangular pin 0.25 x 0.45						
<table border="1"> <thead> <tr> <th colspan="2">Standard SC4</th> </tr> </thead> <tbody> <tr> <td>Insertion</td> <td>320g max.</td> </tr> <tr> <td>Extraction</td> <td>50g min.</td> </tr> </tbody> </table>		Standard SC4		Insertion	320g max.	Extraction	50g min.
Standard SC4							
Insertion	320g max.						
Extraction	50g min.						
ELECTRICAL DATA							
<b>Rated current</b>	1A						
<b>Maxi working voltage</b>	100V <sub>RMS</sub> / 150 V <sub>dc</sub>						
<b>Contact resistance</b>	10 mΩ max						
<b>Dielectric strength</b>	1000 V <sub>RMS</sub> min						

SIP 2mm pitch / Sockets / Solder tail /  
Mating pin 0.47mm / Square 0.50mm /  
Breakable

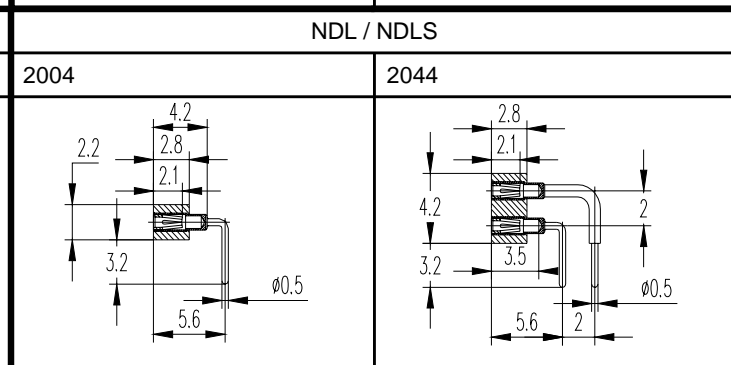
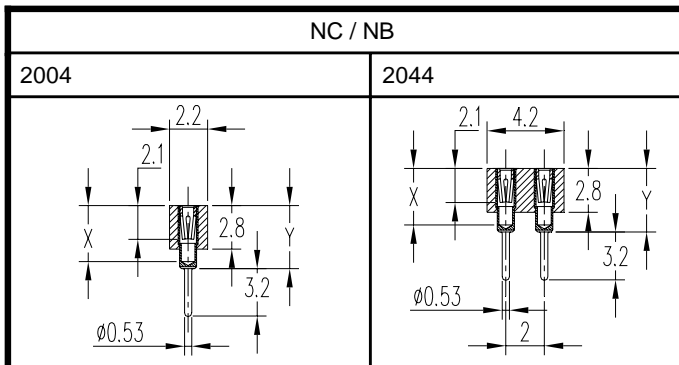
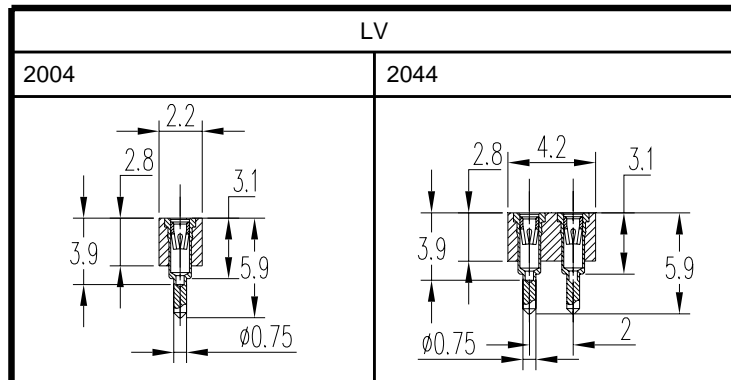
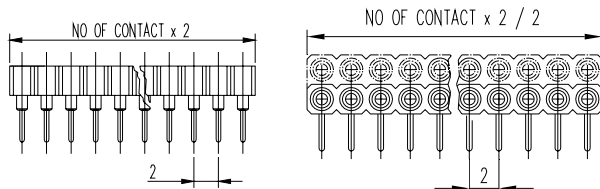
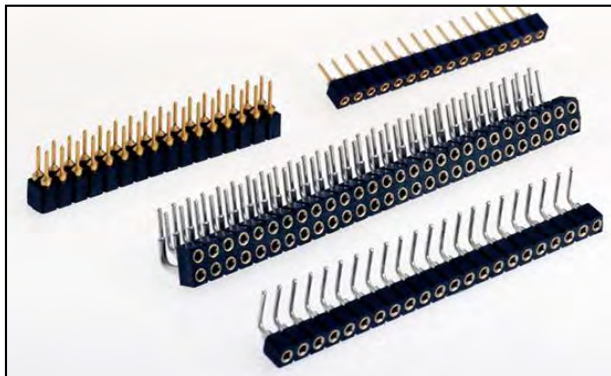

SP	NC	NB
X	3.2mm	3.6mm
Y	3.8mm	4.2mm

Pin style		NC / NB / NDL / NDLS / LV
Plating Sleeve (pin)		5.0µm Tin
Plating contact (clip)		Au 24c flash
TYPE	NP Nbr PIN	ORDERING NUMBERS
2004	50 (*1)	2004HNP.SP.F.0
2044	100 (*2)	2044HNP.SP.F.0

\*1) Availability from 1 to 50 contacts  
\*2) Availability from 4 to 100 contacts

## PLATING OPTIONS

Sleeve (pin), change letter F (5.0µm standard Tin) by:

- .C 0.25µm gold plating
- .O gold flash
- .D tin / lead non-RoHS

Contact (clip), change suffix 0 (standard Au 24c flash) by:

- .1 0.25µm average Au
- .2 0.50µm average Au
- .3 0.75µm average Au
- .4 0.75µm minimum 24c Au (MIL STD)
- .6 5.0µm tin
- .00 5.0µm tin / lead non-RoHS

## TECHNICAL DATA

- Temperature range** -55°C to +125°C
- Insulator body** Glass filled thermoplastic polyester, self-extinguishing, rated UL94V-0  
LCP = high temperature
- Outer shell (sleeve)** Screw machined Brass CuZn36Pb3 (C36000)
- Inner spring contact SC4** Stamped and formed BeCu (C17200) gold or tin plated, accepts Ø0.40-0.56 or rectangular pin 0.25 x 0.45 and for square 0.50mm with SC6.VLI
- Insertion / Extraction** Ø0.43 test pin  
Other forces available upon request.

Standard SC4		SC6.VLI For square 0.50mm	
Insertion	320g max.	Insertion	70g max.
Extraction	50g min.	Extraction	10g min.

To order with inner spring type SC6.VLI (strongly advised mating pin square 0.50mm), add letter B after F instead of the mark.

Example: 2004H28.ND.FB0

The NC serie is available in the press-fit version NCPF.

For solderless mount in a PCB of thickness 1.5-2.4 mm, with plated thru-holes Ø 0.71+/- 0.06 mm.

## ELECTRICAL DATA

- Rated current** 3A
- Maxi working voltage** 100V<sub>RMS</sub> / 150 V<sub>dc</sub>
- Contact resistance** 10 mΩ max
- Dielectric strength** 1000 V<sub>RMS</sub> min



SIP 2mm pitch / Sockets and Headers /  
Solder tail / Mating pin 0.47mm / Breakable

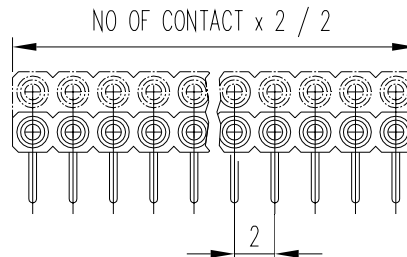
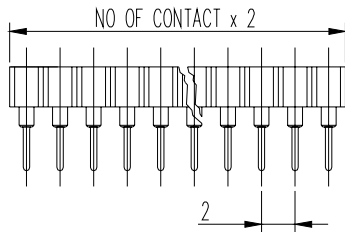
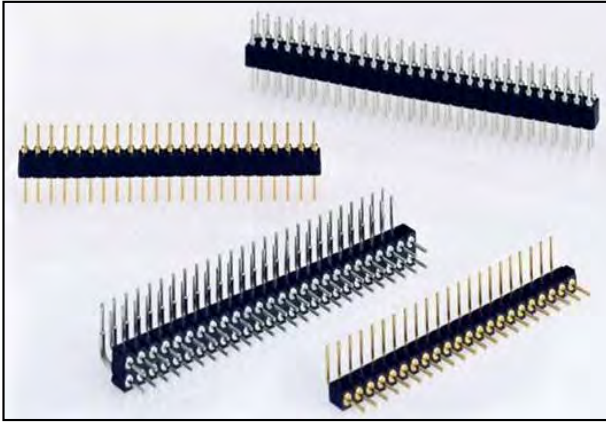

MD		MDL	MDLS
2004	2044	2004	2044

Pin style		MD / MDL / MDLS /
Plating Sleeve (pin)		5.0µm Tin
Plating contact (clip)		Au 24c flash
TYPE	NP Nbr PIN	ORDERING NUMBERS
2004	50 (*1)	2004HNP.SP.F
2044	100 (*2)	2044HNP.SP.F

\*1) Availability from 1 to 50 contacts  
\*2) Availability from 4 to 100 contacts

### PLATING OPTIONS

Sleeve (pin), change letter F (5.0µm standard Tin) by:

- .C 0.25µm gold plating
- .O gold flash
- .D tin / lead non-RoHS
- .S 0.25µm gold plating (connecting side)  
5µm tin (PCB side)
- .S only available for MC style

### TECHNICAL DATA

**Temperature range** -55°C to +125°C  
**Insulator body** Glass filled thermoplastic polyester, self-extinguishing, rated UL94V-0  
LCP = high temperature  
**Outer shell (sleeve)** Screw machined Brass CuZn36Pb3 (C36000)

### ELECTRICAL DATA

**Rated current** 3A  
**Maxi working voltage** 100V<sub>RMS</sub> / 150 V<sub>dc</sub>  
**Contact resistance** 10 mΩ max  
**Dielectric strength** 1000 V<sub>RMS</sub> min



SIP 2mm pitch / Sockets and Headers /  
Gull wing / Mating pin 0.47mm / Square 0.50mm /  
Breakable / Surface mount



Available with Positioning options  
(see GUIDE AND PAD description page 29)

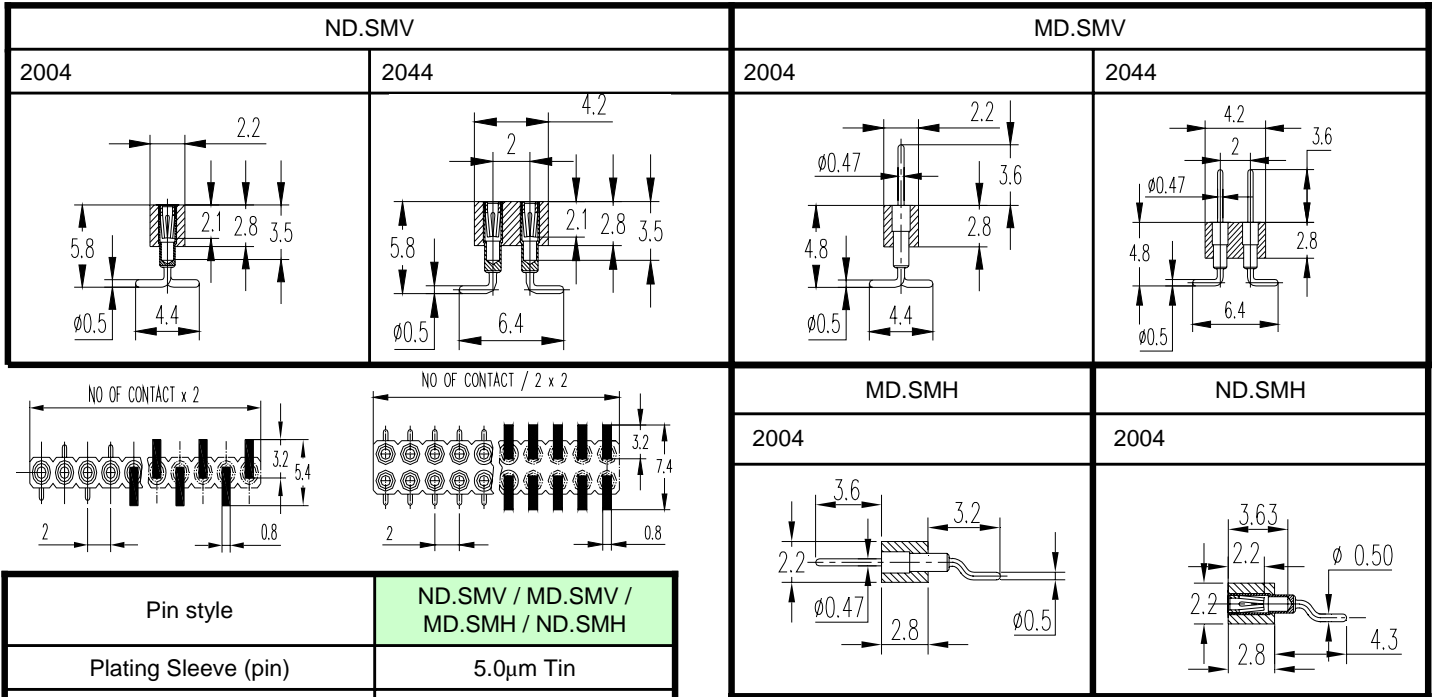

Pin style		ND.SMV / MD.SMV / MD.SMH / ND.SMH
Plating Sleeve (pin)		5.0µm Tin
Plating contact (clip)		Au 24c flash
TYPE	NP Nbr PIN	ORDERING NUMBERS
2004 ND	50 (*1)	2004HNP.SP.F.0
2044 ND	100 (*2)	2044HNP.SP.F.0
2004 MD	50 (*1)	2004HNP.SP.F
2044 MD	100 (*2)	2044HNP.SP.F

\*1) Availability from 3 to 50 contacts  
\*2) Availability from 4 to 100 contacts

## PLATING OPTIONS

Sleeve (pin), change letter F (5.0µm standard Tin) by:

- .C 0.25µm gold plating
- .O gold flash
- .D tin / lead non-RoHS
- .S 0.25µm gold plating (connecting side)  
5µm tin (PCB side)
- .S only available for MD style

Contact (clip), change suffix 0 (standard Au 24c flash) by:

- .1 0.25µm average Au
- .2 0.50µm average Au
- .3 0.75µm average Au
- .4 0.75µm minimum 24c Au (MIL STD)
- .6 5.0µm tin
- .00 5.0µm tin / lead non-RoHS

## TECHNICAL DATA

<b>Temperature range</b>	-55°C to +125°C
<b>Insulator body</b>	Glass filled thermoplastic polyester, self-extinguishing, rated UL94V-0 LCP = high temperature
<b>Outer shell (sleeve)</b>	Screw machined Brass CuZn36Pb3 (C36000)
<b>Inner spring contact SC4</b>	Stamped and formed BeCu (C17200) gold or tin plated, accepts Ø0.40-0.56 or rectangular pin 0.25 x 0.45 and for square 0.50mm with SC6.VLI
<b>Insertion / Extraction</b>	Ø0.43 test pin Other forces available upon request.

Standard SC4		SC6.VLI	
Insertion	320g max.	Insertion	70g max.
Extraction	50g min.	Extraction	10g min.

To order with inner spring type SC6.VLI (strongly advised mating pin square 0.50mm), add letter B after F instead of the mark.  
Example: 2004H28.ND.SMV.FB0

For reverse layout, write R after SMV  
Example: 2004H28.ND.SMVR.FB0

## ELECTRICAL DATA

<b>Rated current</b>	3A
<b>Maxi working voltage</b>	100V <sub>RMS</sub> / 150 V <sub>dc</sub>
<b>Contact resistance</b>	10 mΩ max
<b>Dielectric strength</b>	1000 V <sub>RMS</sub> min

SIP 1.27mm pitch / Sockets / Gull wing /  
Mating pin 0.43mm / Breakable / Surface mount

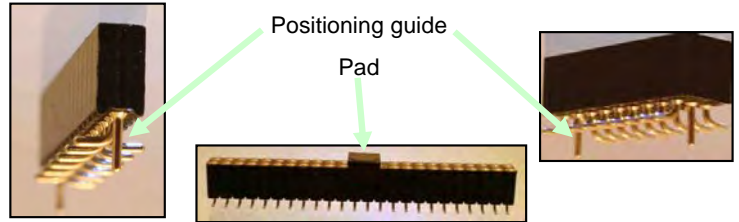
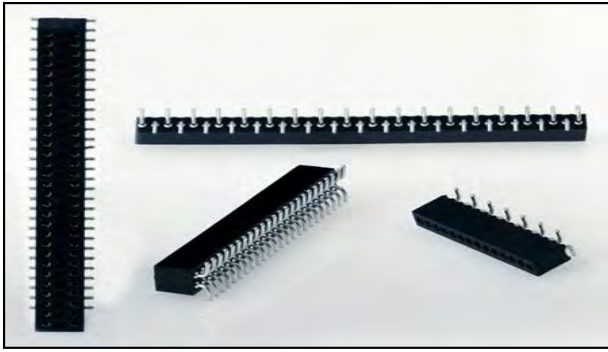

## FH.SMV

4002	4022	4042

Pin style		FH.SMV
Plating Sleeve (pin)		5.0µm Tin
Plating contact (clip)		Au 24c flash
TYPE	NP Nbr PIN	ORDERING NUMBERS
4002	50 (*1)	4002HNP.FH.SMV.F.0
4022	100 (*2)	4022HNP.FH.SMV.F.0
4042	100 (*2)	4042HNP.FH.SMV.F.0

\*1) Availability from 3 to 50 contacts  
\*2) Availability from 4 to 100 contacts

PLATING OPTIONS	
Sleeve (pin), change letter F (5.0µm standard Tin) by:	
➤ .C	0.25µm gold plating
➤ .O	gold flash
➤ .D	tin / lead non-RoHS
Contact (clip), change suffix 0 (standard Au 24c flash) by:	
➤ .1	0.25µm average Au
➤ .2	0.50µm average Au
➤ .3	0.75µm average Au
➤ .4	0.75µm minimum 24c Au (MIL STD)
➤ .6	5.0µm tin
➤ .00	5.0µm tin / lead non-RoHS

Available with Positioning options  
(see GUIDE AND PAD description page 29)

TECHNICAL DATA	
<b>Temperature range</b>	-55°C to +125°C
<b>Insulator body</b>	Glass filled thermoplastic polyester, self-extinguishing, rated UL94V-0 PCT = high temperature
<b>Outer shell (sleeve)</b>	Screw machined Brass CuZn36Pb3 (C36000)
<b>Inner spring contact SC3</b>	Stamped and formed BeCu (C17200) gold or tin plated, accepts Ø0.35-0.50
<b>Insertion / Extraction</b>	Ø0.43 test pin Other forces available upon request.
Standard SC3	
Insertion	150g max.
Extraction	30g min.

ELECTRICAL DATA	
<b>Rated current</b>	1A
<b>Maxi working voltage</b>	100V <sub>RMS</sub> / 150 V <sub>dc</sub>
<b>Contact resistance</b>	20 mΩ max
<b>Dielectric strength</b>	500 V <sub>RMS</sub> min

SIP 1.27mm pitch / Headers / Gull wing / Breakable / Surface mount

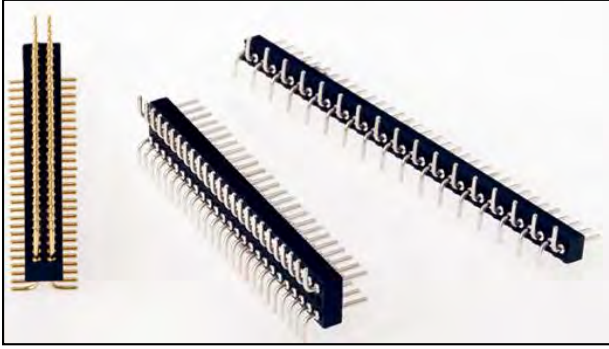

## MH.SMV

4002	4022	4042

\*For a whole insulator: tolerance = +0.41

\*For a cut insulator: tolerance = ±0.2

Available with Positioning options  
(see GUIDE AND PAD description page 29)

Pin style		FH.SMV
Plating Sleeve (pin)		5.0µm Tin
Plating contact (clip)		Au 24c flash
TYPE	NP Nbr PIN	ORDERING NUMBERS
4002	50 (*1)	4002HNP.MH.SMV.F.0
4022	100 (*2)	4022HNP.MH.SMV.F.0
4042	100 (*2)	4042HNP.MH.SMV.F.0

\*1) Availability from 3 to 50 contacts

\*2) Availability from 4 to 100 contacts

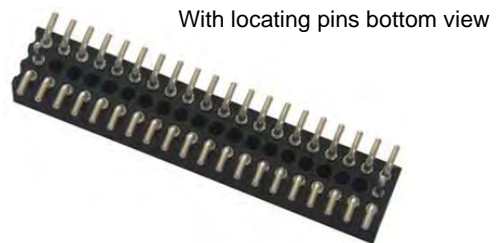

## TECHNICAL DATA

<b>Temperature range</b>	-55°C to +125°C
<b>Insulator body</b>	Glass filled thermoplastic polyester, self-extinguishing, rated UL94V-0 PCT = high temperature
<b>Outer shell (sleeve)</b>	Screw machined Brass CuZn36Pb3 (C36000)

## ELECTRICAL DATA

<b>Rated current</b>	1A
<b>Maxi working voltage</b>	100V <sub>RMS</sub> / 150 V <sub>dc</sub>
<b>Contact resistance</b>	20 mΩ max
<b>Dielectric strength</b>	500 V <sub>RMS</sub> min

## PLATING OPTIONS

Sleeve (pin), change letter F (5.0µm standard Tin) by:

- .C 0.25µm gold plating
- .O gold flash
- .D tin / lead non-RoHS

SIP 1.27mm pitch / Sockets and Headers / Breakable / Surface mount horizontal

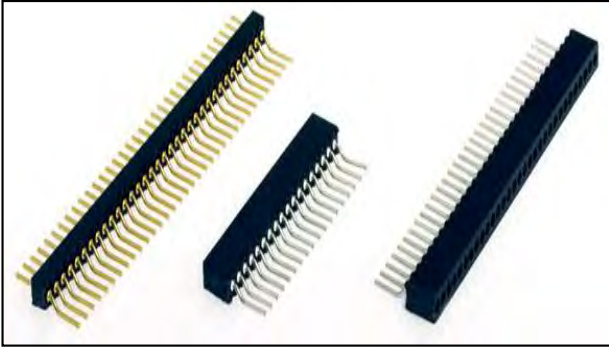

## PACKAGING OPTIONS

Box	Standard Example: 4002HNP.MH.SMH.F.0
Tape & Reel	Change the dash after NP into B Example: 4002HNPBMH.SMH.F.0
Tube	Change the dash after NP into T Example: 4002HNPTMH.SMH.F.0
Tray	Change the dash after NP into R Example: 4002HNPRMH.SMH.F.0

Please contact the customer service for availability

MH.SMH	MH.SMHP	MH.SMHS	FH.SMH / FH.SMHS

\*For a whole insulator: tolerance = +0.41  
\*For a cut insulator: tolerance = ±0.2

Pin style		MH. SMH / MH.SMHP / MH.SMHS / FH.SMH / FH.SMHS
Plating Sleeve (pin)		5.0µm Tin
Plating contact (clip)		Au 24c flash
TYPE	NP Nbr PIN	ORDERING NUMBERS
4002	50 (*1)	4002HNP.FH.SMH.F.0
4002	50 (*1)	4022HNP.MH.SMH.C

\*1) Availability from 1 to 50 contacts

SP	FH.SMH	FH.SMHS
PIN LENGTH X	4.8	3.7

## TECHNICAL DATA

<b>Temperature range</b>	-55°C to +125°C
<b>Insulator body</b>	Glass filled thermoplastic polyester, self-extinguishing, rated UL94V-0 PCT = high temperature
<b>Outer shell (sleeve)</b>	Screw machined Brass CuZn36Pb3 (C36000)
<b>Inner spring contact SC3</b>	Stamped and formed BeCu (C17200) gold or tin plated, accepts Ø0.35-0.50
<b>Insertion / Extraction</b>	Ø0.43 test pin Other forces available upon request.

### Standard SC3

Insertion	150g max.
Extraction	30g min.

## ELECTRICAL DATA

<b>Rated current</b>	1A
<b>Maxi working voltage</b>	100V <sub>RMS</sub> / 150 V <sub>dc</sub>
<b>Contact resistance</b>	20 mΩ max
<b>Dielectric strength</b>	500 V <sub>RMS</sub> min

## PLATING OPTIONS

Sleeve (pin), change letter F (5.0µm standard Tin) by:

- .C 0.25µm gold plating
- .O gold flash
- .D tin / lead non-RoHS

Contact (clip), change suffix 0 (standard Au 24c flash) by:

- .1 0.25µm average Au
- .2 0.50µm average Au
- .3 0.75µm average Au
- .4 0.75µm minimum 24c Au (MIL STD)
- .6 5.0µm tin
- .00 5.0µm tin / lead non-RoHS

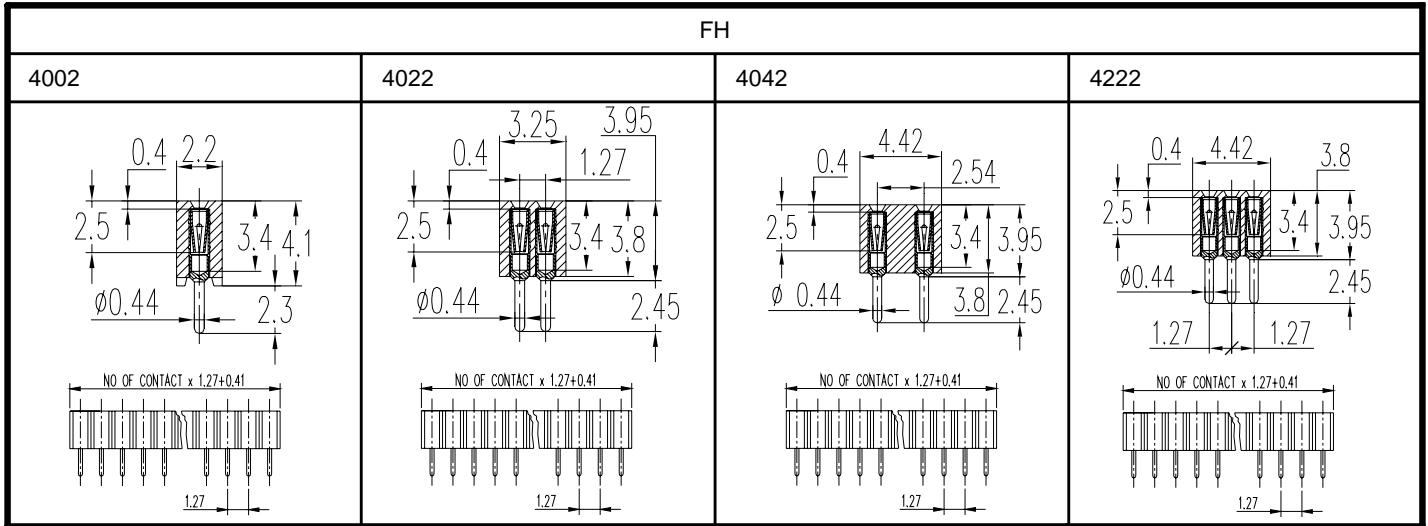
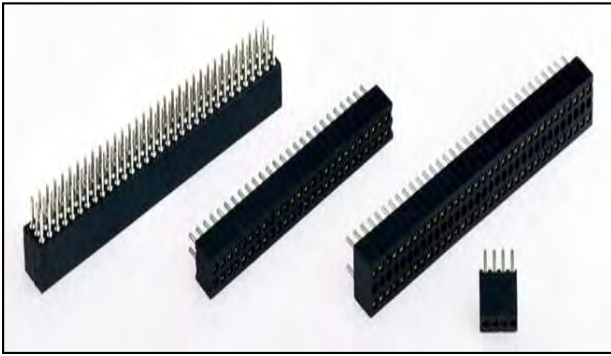

Pin style		FH
Plating Sleeve (pin)		5.0µm Tin
Plating contact (clip)		Au 24c flash
TYPE	NP Nbr PIN	ORDERING NUMBERS
4002	50 (*1)	4002HNP.FH.F.0
4022	100 (*2)	4022HNP.FH.F.0
4042	100 (*2)	4042HNP.FH.F.0
4222	150 (*3)	4222HNP.FH.F.0

- \*1) Availability from 1 to 50 contacts
- \*2) Availability from 4 to 100 contacts
- \*3) Availability from 9 to 150 contacts

### PLATING OPTIONS

Sleeve (pin), change letter F (5.0µm standard Tin) by:

- .C 0.25µm gold plating
- .O gold flash
- .D tin / lead non-RoHS

Contact (clip), change suffix 0 (standard Au 24c flash) by:

- .1 0.25µm average Au
- .2 0.50µm average Au
- .3 0.75µm average Au
- .4 0.75µm minimum 24c Au (MIL STD)
- .6 5.0µm tin
- .00 5.0µm tin / lead non-RoHS

### TECHNICAL DATA

**Temperature range** -55°C to +125°C

**Insulator body** Glass filled thermoplastic polyester, self-extinguishing, rated UL94V-0  
PCT = high temperature

**Outer shell (sleeve)** Screw machined Brass CuZn36Pb3 (C36000)

**Inner spring contact SC3** Stamped and formed BeCu (C17200) gold or tin plated, accepts Ø0.35-0.50

**Insertion / Extraction** Ø0.43 test pin  
Other forces available upon request.

Standard SC3	
Insertion	150g max.
Extraction	30g min.

### ELECTRICAL DATA

<b>Rated current</b>	1A
<b>Maxi working voltage</b>	100V <sub>RMS</sub> / 150 V <sub>dc</sub>
<b>Contact resistance</b>	20 mΩ max
<b>Dielectric strength</b>	500 V <sub>RMS</sub> min



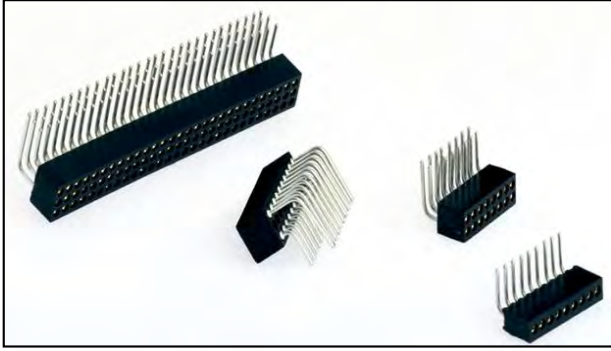

FH.F.L

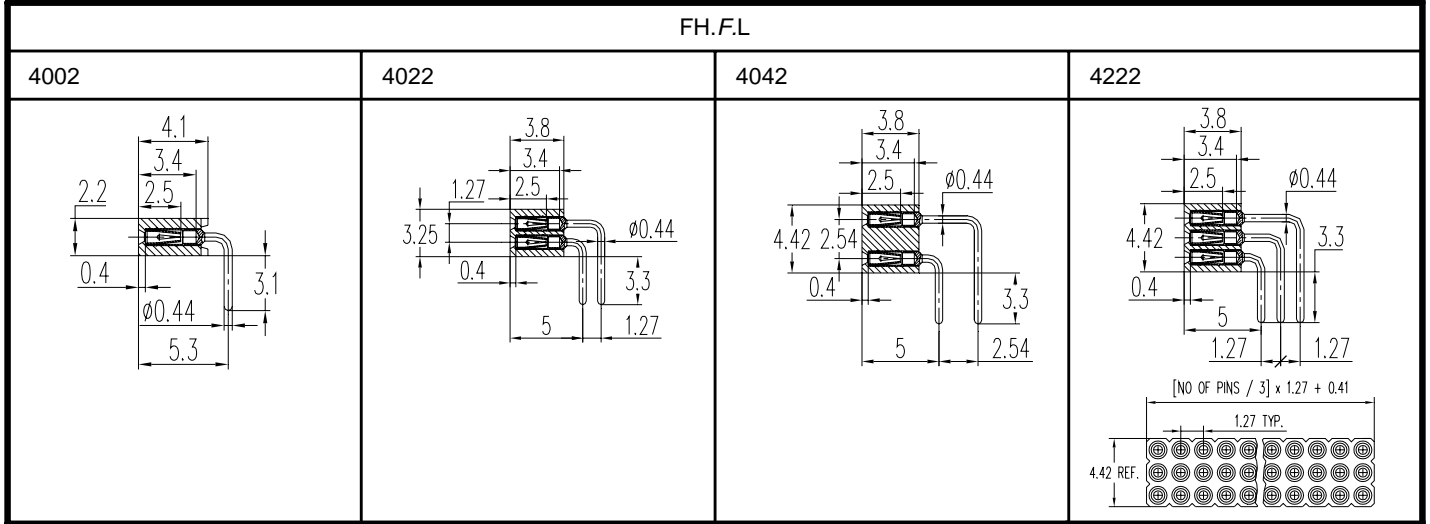

Pin style		FH.F.L
Plating Sleeve (pin)		5.0µm Tin
Plating contact (clip)		Au 24c flash
TYPE	NP Nbr PIN	ORDERING NUMBERS
4002	50 (*1)	4002HNP.FH.F.L.0
4022	100 (*2)	4022HNP.FH.F.L.0
4042	100 (*2)	4042HNP.FH.F.L.0
4222	150 (*3)	4222HNP.FH.F.L.0

- \*1) Availability from 1 to 50 contacts
- \*2) Availability from 4 to 100 contacts
- \*3) Availability from 6 to 150 contacts

### PLATING OPTIONS

Sleeve (pin), change letter F (5.0µm standard Tin) by:

- .C 0.25µm gold plating
- .O gold flash
- .D tin / lead non-RoHS

Contact (clip), change suffix 0 (standard Au 24c flash) by:

- .1 0.25µm average Au
- .2 0.50µm average Au
- .3 0.75µm average Au
- .4 0.75µm minimum 24c Au (MIL STD)
- .6 5.0µm tin
- .00 5.0µm tin / lead non-RoHS

### TECHNICAL DATA

- Temperature range** -55°C to +125°C
- Insulator body** Glass filled thermoplastic polyester, self-extinguishing, rated UL94V-0  
PCT = high temperature
- Outer shell (sleeve)** Screw machined Brass CuZn36Pb3 (C36000)
- Inner spring contact SC3** Stamped and formed BeCu (C17200) gold or tin plated, accepts Ø0.35-0.50
- Insertion / Extraction** Ø0.43 test pin  
Other forces available upon request.

Standard SC4.SM	
Insertion	150g max.
Extraction	30g min.

### ELECTRICAL DATA

- Rated current** 1A
- Maxi working voltage** 100V<sub>RMS</sub> / 150 V<sub>dc</sub>
- Contact resistance** 20 mΩ max
- Dielectric strength** 500 V<sub>RMS</sub> min



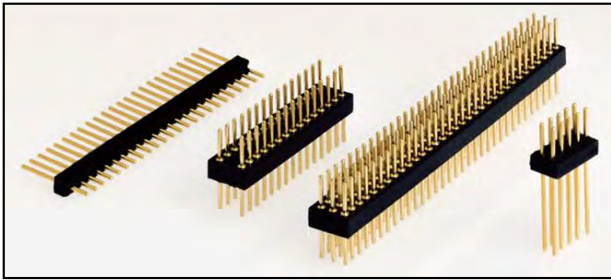

MH			
4002	4022	4042	4222
<div style="border: 1px solid black; padding: 5px; display: inline-block;"> <p>*For a whole insulator: tolerance = +0.41</p> <p>*For a cut insulator: tolerance = ±0.2</p> </div>			

Pin style		MH
Plating Sleeve (pin)		5.0µm Tin
TYPE	NP Nbr PIN	ORDERING NUMBERS
4002	50 (*1)	4002HNP.MH.C.LP
4022	100 (*2)	4022HNP.MH.C.LP
4042	100 (*2)	4042HNP.MH.C
4222	150 (*3)	4222HNP.MH.C

- \*1) Availability from 1 to 50 contacts
- \*2) Availability from 4 to 100 contacts
- \*3) Availability from 9 to 150 contacts

LP	X
08	3.2mm
09	3.6mm
12	6.6mm
13	7.9mm
15	10.0mm
Other pin length X upon request.	

TECHNICAL DATA	
<b>Temperature range</b>	-55°C to +125°C
<b>Insulator body</b>	Glass filled thermoplastic polyester, self-extinguishing, rated UL94V-0 PCT = high temperature (order with H) Example: 2700H32.SD.F.0
<b>Outer shell (sleeve)</b>	Screw machined Brass CuZn36Pb3 (C36000)

ELECTRICAL DATA	
<b>Rated current</b>	1A
<b>Maxi working voltage</b>	100V <sub>RMS</sub> / 150 V <sub>dc</sub>
<b>Contact resistance</b>	20 mΩ max
<b>Dielectric strength</b>	500 V <sub>RMS</sub> min

## PLATING OPTIONS

Sleeve (pin), change letter F (5.0µm standard Tin) by:

- .C 0.25µm gold plating
- .O gold flash

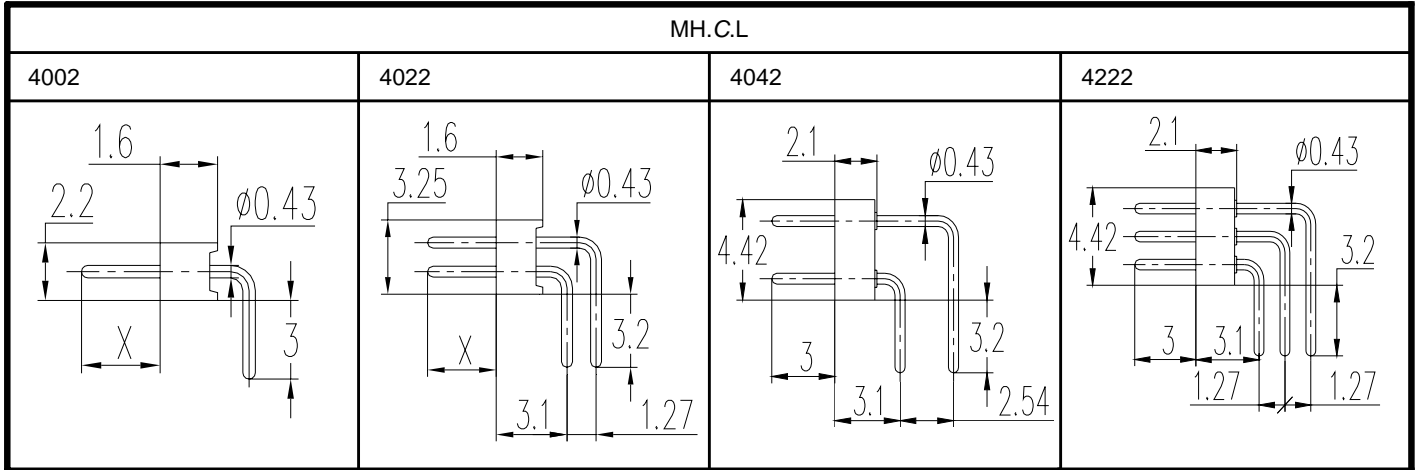
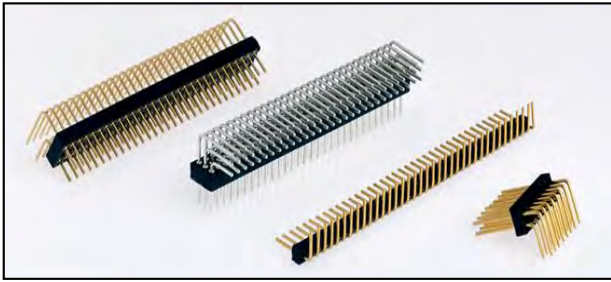

LP	X
08	3.2mm
09	3.6mm
12	6.6mm
13	7.9mm
15	10.0mm
Other pin length X upon request.	

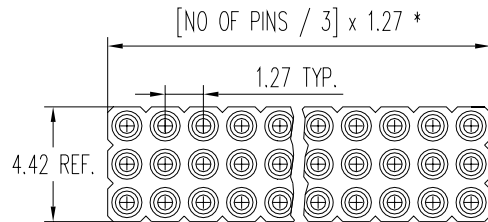

\*For a whole insulator: tolerance = +0.41  
 \*For a cut insulator: tolerance = ±0.2

Pin style		MH.C.L
Plating Sleeve (pin)		5.0µm Tin
TYPE	NP Nbr PIN	ORDERING NUMBERS
4002	50 (*1)	4002.NP.MH.C.L.LP
4022	100 (*2)	4022.NP.MH.C.L.LP
4042	100 (*2)	4042.NP.MH.C.L
4222	150 (*3)	4222.NP.MH.C.L

\*1) Availability from 1 to 50 contacts  
 \*2) Availability from 4 to 100 contacts  
 \*3) Availability from 6 to 150 contacts

### TECHNICAL DATA

<b>Temperature range</b>	-55°C to +125°C
<b>Insulator body</b>	Glass filled thermoplastic polyester, self-extinguishing, rated UL94V-0 PBT = Standard PCT = high temperature (order with H) Example: 4022H32.MH.C.L
<b>Outer shell (sleeve)</b>	Screw machined Brass CuZn36Pb3 (C36000)

### PLATING OPTIONS

Sleeve (pin), change letter F (5.0µm standard Tin) by:

- .C 0.25µm gold plating
- .O gold flash

### ELECTRICAL DATA

<b>Rated current</b>	1A
<b>Maxi working voltage</b>	100V <sub>RMS</sub> / 150 V <sub>dc</sub>
<b>Contact resistance</b>	20 mΩ max
<b>Dielectric strength</b>	500 V <sub>RMS</sub> min

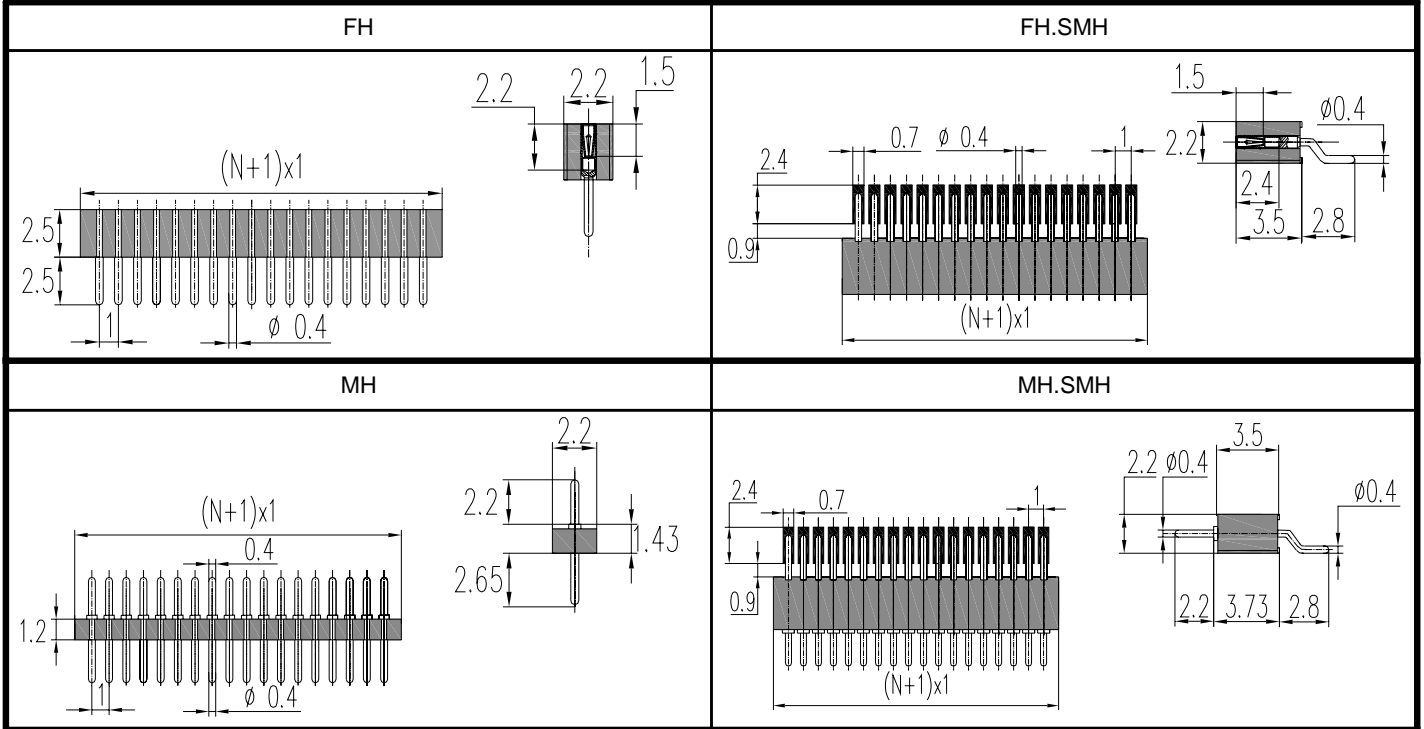
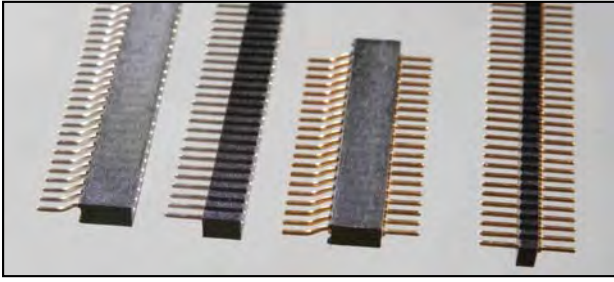

Pin style		FH / FH.SMH / MH / MH.SMH
Plating Sleeve (pin)		5.0 $\mu$ m Tin (socket) 0.25 $\mu$ m Au (head)
Plating contact (clip)		Au 24c flash
TYPE	NP Nbr PIN	ORDERING NUMBERS
2006 (FH)	50 (*1)	2006HNP.FH.F.0
2006 (FH.SMH)	50 (*1)	2006HNP.FH.SMH.F.0
2006 (MH)	50 (*1)	2006HNP.MH.C
2006 (MH.SMH)	50 (*1)	2006HNP.MH.SMH.C

\*1) Availability from 2 to 50 contacts

## PLATING OPTIONS

Sleeve (pin), change letter F (5.0 $\mu$ m standard Tin) by:

- .C 0.25 $\mu$ m gold plating
- .O gold flash
- .D tin / lead non-RoHS

Contact (clip), change suffix 0 (standard Au 24c flash) by:

- .1 0.25 $\mu$ m average Au
- .4 0.75 $\mu$ m minimum 24c Au (MIL STD)
- .6 5.0 $\mu$ m tin

## TECHNICAL DATA

<b>Temperature range</b>	-55°C to +125°C
<b>Insulator body</b>	Glass filled thermoplastic polyester, self-extinguishing, rated UL94V-0 PCT = high temperature
<b>Outer shell (sleeve)</b>	Screw machined Brass CuZn36Pb3 (C36000)
<b>Inner spring contact SC4</b>	Stamped and formed BeCu (C17200) gold or tin plated, accepts $\phi 0.36-0.46$
<b>Insertion / Extraction</b>	$\phi 0.40$ test pin

Standard	
Insertion	25g medium
Extraction	15g medium

## ELECTRICAL DATA

<b>Rated current</b>	1A
<b>Maxi working voltage</b>	100V <sub>RMS</sub> / 150 V <sub>dc</sub>
<b>Contact resistance</b>	10 m $\Omega$ max
<b>Dielectric strength</b>	500 V <sub>RMS</sub> min

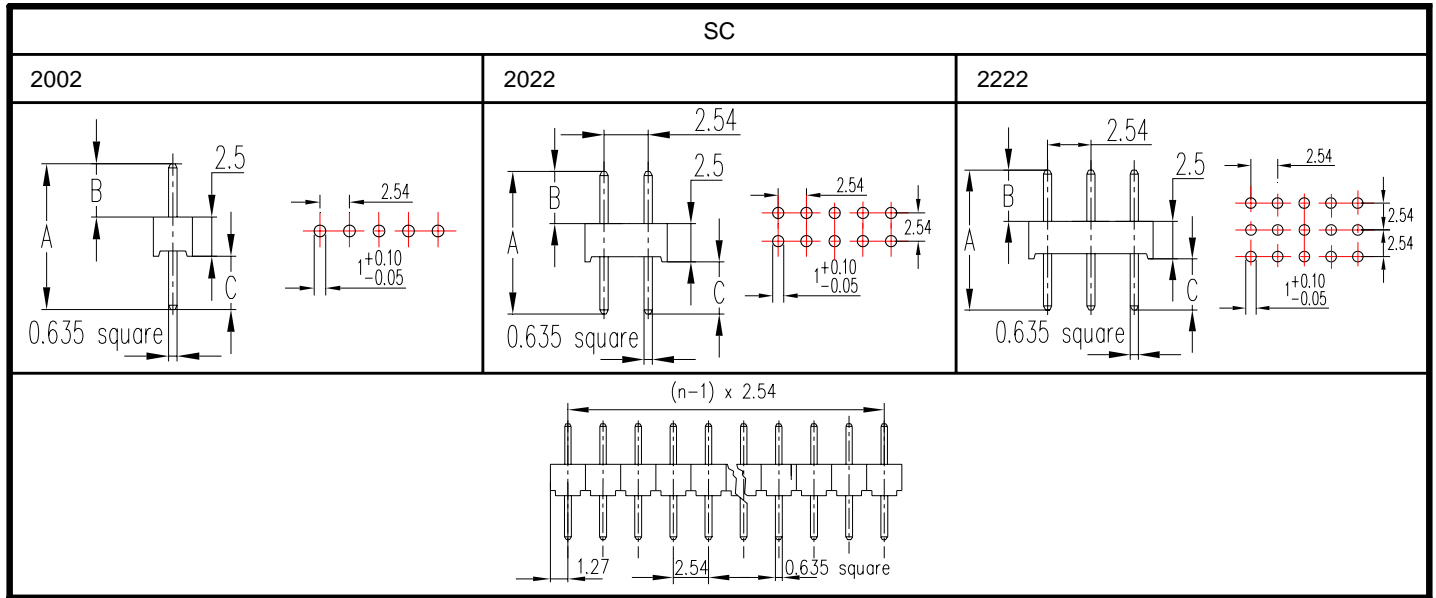
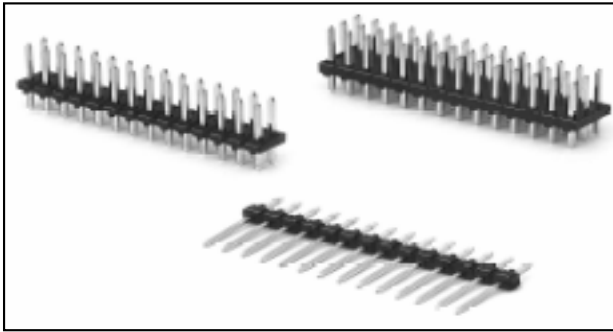

LP	A	B	C
10	10.2mm	5.2mm	2.5mm
11	10.8mm	5.8mm	2.5mm
12	11.3mm	5.3mm	3.3mm
13	12.6mm	6.8mm	3.3mm
14	13.9mm	8.1mm	3.3mm
15	14.7mm	8.9mm	3.3mm
16	17.7mm	11.9mm	3.3mm
17	19.8mm	14.0mm	3.3mm
18	21.6mm	15.8mm	3.3mm
19	22.8mm	17.0mm	3.3mm
20	24.9mm	19.1mm	3.3mm

Other pin length X upon request.

Pin style		SC
Plating sleeve (pin)		Au 24c flash
TYPE	NP Nbr PIN	ORDERING NUMBERS
4002	50 (*1)	2002HNP.SC.C.LP
4022	100 (*2)	2022HNP.SC.C.LP
4222	150 (*3)	2222HNP.SC.C.LP

\*1) Availability from 1 to 50 contacts  
\*2) Availability from 4 to 100 contacts  
\*3) Availability from 9 to 150 contacts

## PLATING OPTIONS

Sleeve (pin), change letter F (5.0µm standard Tin) by:

- .C 0.25µm gold plating
- .O gold flash
- .B 0.75µm gold plating
- .S 0.25µm gold plating (connecting side)  
5µm tin (PCB side)
- .S2 0.75µm gold plating (connecting side)  
5µm tin (PCB side)

## TECHNICAL DATA

<b>Temperature range</b>	-55°C to +125°C
<b>Insulator body</b>	Glass filled thermoplastic polyester, self-extinguishing, rated UL94V-0
<b>Outer shell (sleeve)</b>	Square pin 0.635mm, CuZn30 acc. To Din 17660

## ELECTRICAL DATA

<b>Rated current</b>	3A
<b>Current voltage</b>	250V AC
<b>Contact resistance</b>	20 mΩ max
<b>Dielectric strength</b>	1000 V <sub>RMS</sub> min

SIP 2.54mm pitch / Headers / Solder tail /  
Mating pin square 0.635mm / Right angle /  
Breakable

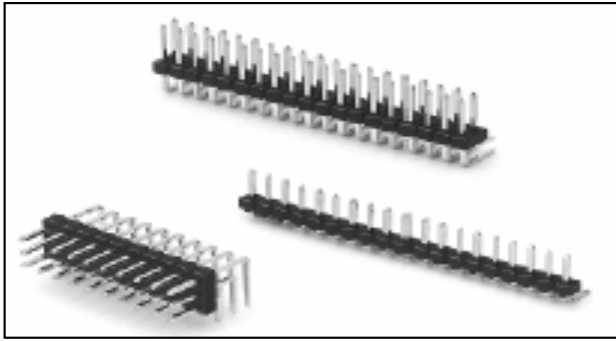

## SL

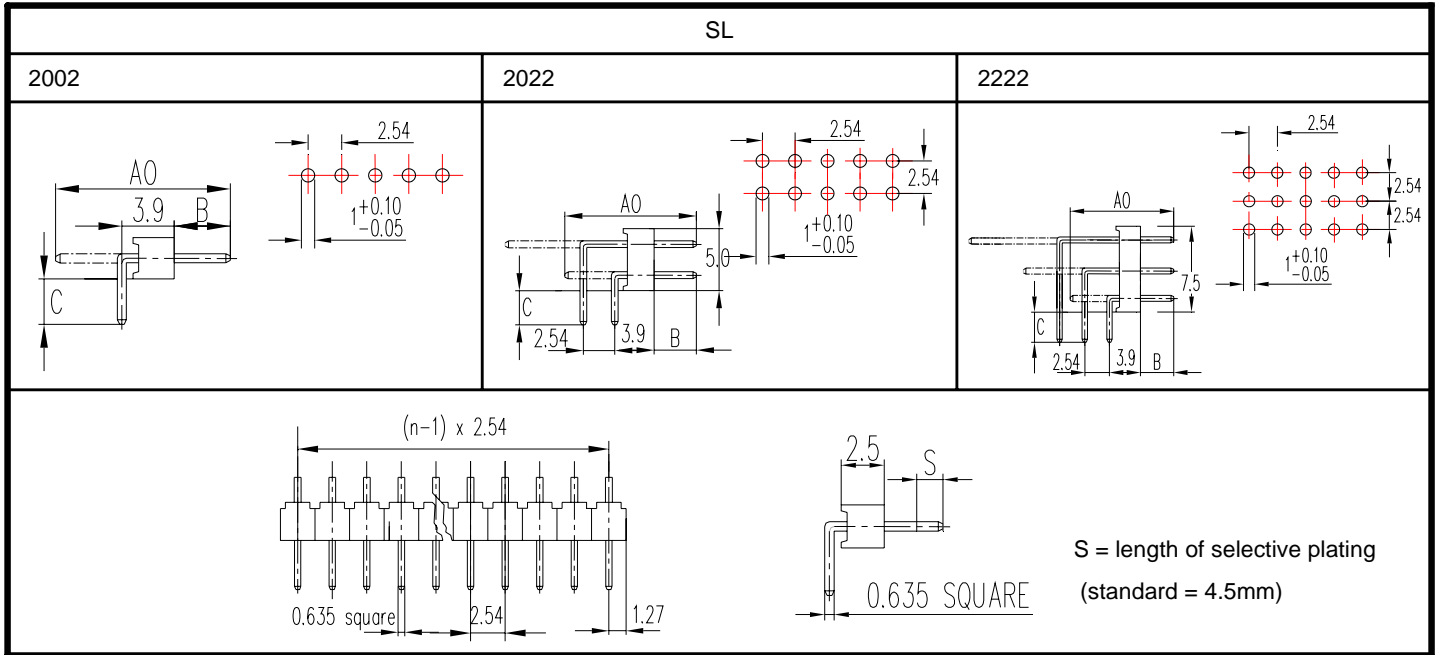

Pin style		SL
Plating sleeve (pin)		Au 24c flash
TYPE	NP Nbr PIN	ORDERING NUMBERS
4002	50 (*1)	2002HNP.SL.C.LP
4022	100 (*2)	2022HNP.SL.C.LP
4222	150 (*3)	2222HNP.SL.C.LP

\*1) Availability from 1 to 50 contacts

\*2) Availability from 4 to 100 contacts

\*3) Availability from 9 to 150 contacts

LP	AO	B	C
12	11.3mm	3.5mm	3.3mm
13	12.6mm	4.8mm	3.3mm
14	13.9mm	6.1mm	3.3mm
15	14.7mm	6.9mm	3.3mm
16	17.7mm	9.9mm	3.3mm
17	19.8mm	12.0mm	3.3mm
18	21.6mm	13.8mm	3.3mm
19	22.8mm	15.0mm	3.3mm
20	24.9mm	17.1mm	3.3mm

Other pin length X upon request.

## PLATING OPTIONS

Sleeve (pin), change letter C (0.25µm gold plating) by:

- .O gold flash
- .F 5.0µm standard Tin
- .B 0.75µm gold plating
- .S 0.25µm gold plating (connecting side)  
5µm tin (PCB side)
- .S2 0.75µm gold plating (connecting side)  
5µm tin (PCB side)

## TECHNICAL DATA

Temperature range	-55°C to +125°C
Insulator body	Glass filled thermoplastic polyester, self-extinguishing, rated UL94V-0
Outer shell (sleeve)	Square pin 0.635mm, CuZn30 acc. To Din 17660

## ELECTRICAL DATA

Rated current	3A
Current voltage	250V AC
Contact resistance	20 mΩ max
Dielectric strength	1000 V <sub>RMS</sub> min

SIP 2mm pitch / Headers / Solder tail /  
Mating pin square 0.5mm /  
Straight and right angle / Breakable

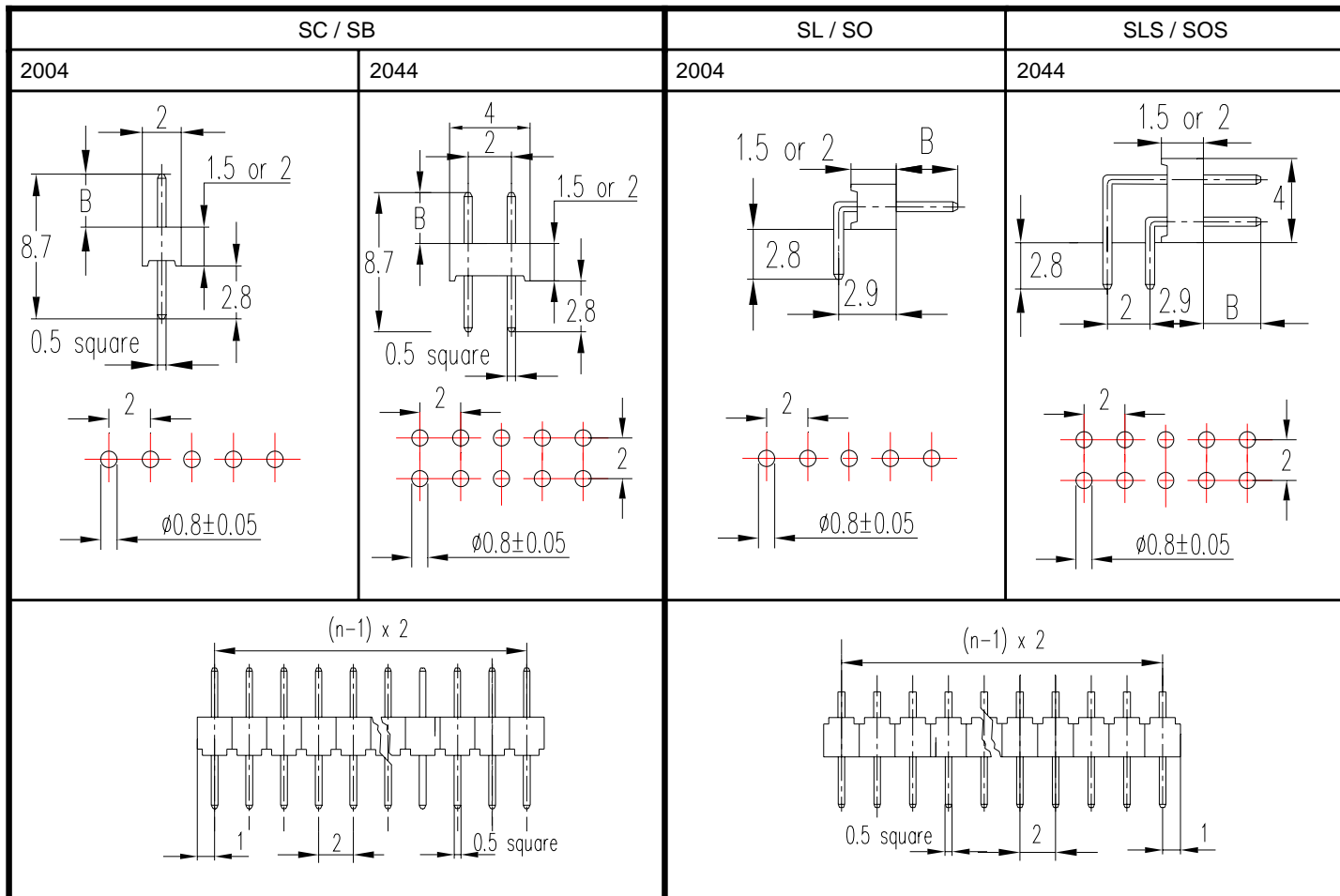

Pin style		SC / SB / SL / SO / SLS / SOS
Plating Sleeve (pin)		Au 24c flash
TYPE	NP Nbr PIN	ORDERING NUMBERS
2004	40 (*1)	2004.NP.SP.0
2044	100 (*2)	2044.NP.SP.0

\*1) Availability from 1 to 40 contacts  
\*2) Availability from 2 to 80 contacts

SP	SC	SB	SL	SO	SLS	SOS
PIN LENGTH B	4.4mm	3.9mm	4.4mm	3.9mm	4.4mm	3.9mm
INSULATOR HEIGHT	1.5mm	2mm	1.5mm	2mm	1.5mm	2mm

TECHNICAL DATA	
Temperature range	-55°C to +125°C
Insulator body	Glass filled thermoplastic polyester, self-extinguishing, rated UL94V-0
Outer shell (sleeve)	Square pin 0.635mm, CuZn30 acc. To Din 17660

PLATING OPTIONS	
Sleeve (pin), change letter O (gold flash) by:	
➤ .F	5.0µm standard Tin
➤ .S	0.25µm gold plating (connecting side) 5µm tin (PCB side)

ELECTRICAL DATA	
Rated current	3A
Current voltage	250V AC
Contact resistance	20 mΩ max
Dielectric strength	500 V <sub>RMS</sub> min



PCB

SERIES		2001 / 2011 / 2111	3001 / 3011 / 3111 / 3211	4001 / 4011	5001 / 5011 / 6001 / 6011	7001 / 7011
		Height 7mm	Height 4.2mm	Height 2.95mm	Height 8-8.5mm	
SP						
SOCKETS	PFH	60	63	64	66	67
	PFHW	60				
	PFH.F.L	61		64		
	PFA	60				
	PFB	60				
	PFH.SMV	62		65		
	PFH.SMH PFH.SMHP	62		65		
	GCP			64		

## Standard PCB

2001 . NP . SP . F . 0 . LP

Series.  
For insulator without center bar  
replace 0 by 1 at the serie n° end.

.	Standard
A	Automatic (Only with pin CC)
H	High temperature insulator
HA	High temperature Automatic ass.

Number of pins

Type of contacts

.-standard

For pitch x2, x3,x4, or other pitch:

Example: 2001H20.PFH2F.0 (2.54X2=5.08)

Length code  
(only for series for those is needed)

Clip plating option

.	Standard on catalog page
A	SC4
B	SC6.VLI
C	SC6.065
?	Etc.

Pin plating option

Available with Positioning options (see GUIDE AND PAD description page 29)

## Custom PCB

2001 . NP / 16 . SP . F . 0 . LP

Series  
For insulator without center bar  
replace 0 by 1 at the serie n°

.	Standard
A	Automatic (Only with pin CC)
H	High temperature
HA	High temperature Automatic

Number of pins

/ = first version, B,C,... next versions

Number of positions

2011.8/16.PFH.F.0

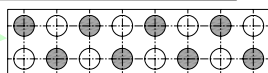

Length code  
(only for series for those is needed)

Clip plating option

.	Standard on catalog page
A	SC4
B	SC6.VLI
?	Etc.

Pin plating option

.-standard

For pitch x2, x3,x4, or other pitch:

Example: 2001H20/16.PFH2F.0 (2.54X2=5.08)

Type of contacts

Available with Positioning options (see GUIDE AND PAD description page 29)

To order a special PCB

Customer			
Address			
ZIP	City		
Country			
Phone			
Fax			
E-mail			

Series	
Type of construction	
Number of pins	
Number of positions	
Type of contact (can be yours)	
Pin plating option	
Type of clip (can be yours)	
Clip plating option	
Length code (if requested)	

## PCB

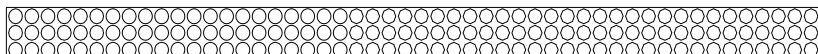

Fill in the holes where you want the contacts. If your request isn't standard, please send us a detailed drawing. For the very specific design, insulator is made in Epoxy.

PCB 2.54mm pitch / Sockets / Solder tail /  
Wire-wrap / Mating pin 0.47mm / 0.76mm / 1mm /  
Strip / Height 7mm

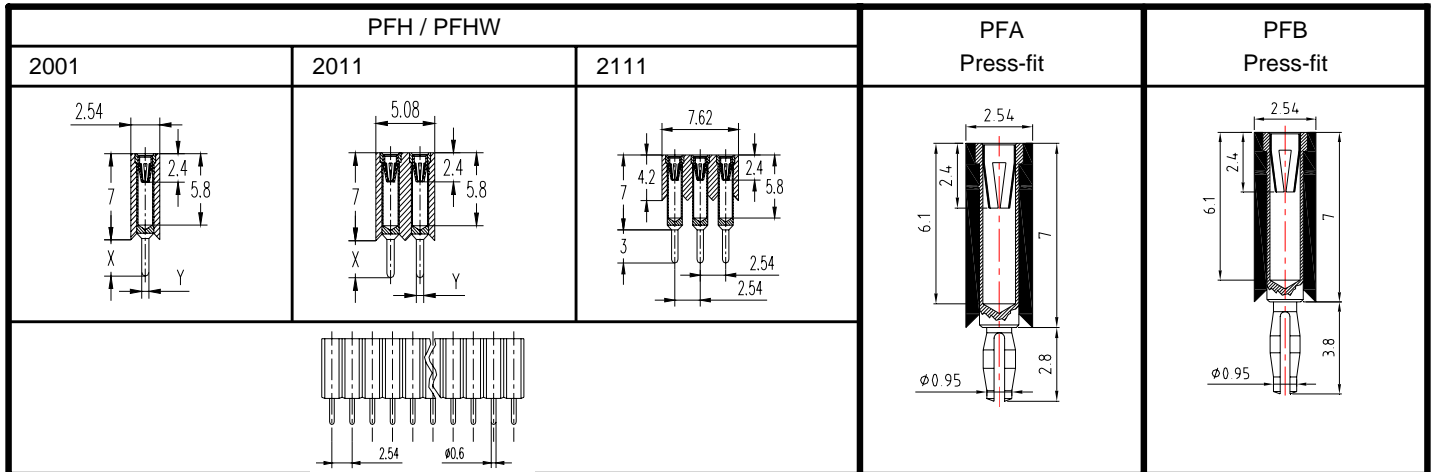

SP	PFH Solder tail straight	PFHW Wire-wrap
X	3mm	*4mm
Y	Ø0.60mm	
*For 4mm, add 4 after F Example: 2001.36.PFH.F4.0		

Pin style		PFH / PFHW / PFA / PFB
Plating Sleeve (pin)		5.0µm Tin
Plating contact (clip)		Au 24c flash
TYPE	NP Nbr PIN	ORDERING NUMBERS
2001	36 50 (*1)	2001.NP.SP.F.LP.0
2011	72 100 (*2)	2011.NP.SP.F.LP.0
2111	96 (*3)	2111.NP.SP.F.LP.0

\*1) Availability from 1 to 50 contacts

\*2) Availability from 2 to 100 contacts

\*3) Availability from 3 to 96 contacts

## PLATING OPTIONS

Sleeve (pin), change letter F (5.0µm standard Tin) by:

- .C 0.25µm gold plating
- .O gold flash

Contact (clip), change suffix 0 (standard Au 24c flash) by:

- .1 0.25µm average Au
- .4 0.75µm minimum 24c Au (MIL STD)
- .6 5.0µm tin
- .00 5.0µm tin / lead non-RoHS

## TECHNICAL DATA

<b>Temperature range</b>	-55°C to +125°C
<b>Insulator body</b>	Glass filled thermoplastic polyester, self-extinguishing, rated UL94V-0 PCB = standard PCT = high temperature (order with H) Example: 2001H28.PFH.F.0
<b>Outer shell (sleeve)</b>	Screw machined Brass CuZn36Pb3 (C36000)
<b>Inner spring contact SC6.065</b>	Stamped and formed BeCu (C17200) gold or tin plated, accepts Ø0.65-0.85 or rectangular pin 0.65 x 0.65
<b>Insertion / Extraction</b>	Per line Other forces available upon request.

Standard SC6.065	
Insertion	100g max.
Extraction	30g min.

### Other hard forces available upon request

Insertion max 375gr and extraction min 100gr.

To order with hard force add letter V after the F instead of the mark.

Example: 2001.50.PFH.FV0

### Other mating pin available upon request

To order with inner spring type SC4 (insertion Ø0.40-0.56) or SC6.VLI (insertion Ø0.40-0.56), add letter A (SC4) or B (SC6.VLI) after F instead of the mark. For insertion Ø0.95-1.05, add letter I.

Examples: 2001.50.PFH.FA0 or 2001.50.PFH.FI0

A, B and I available only for straight type.

## ELECTRICAL DATA

<b>Rated current</b>	3A
<b>Maxi working voltage</b>	100V <sub>RMS</sub> / 150 V <sub>dc</sub>
<b>Contact resistance</b>	10 mΩ max
<b>Dielectric strength</b>	1000 V <sub>RMS</sub> min

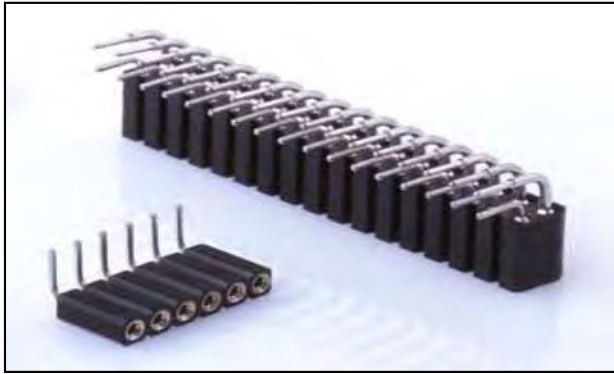

## SERIES 2001,2011

PCB 2.54mm pitch / Sockets / Solder tail /  
Wire-wrap / Mating pin 0.47mm / 0.76mm / 1mm /  
Strip / Height 7mm

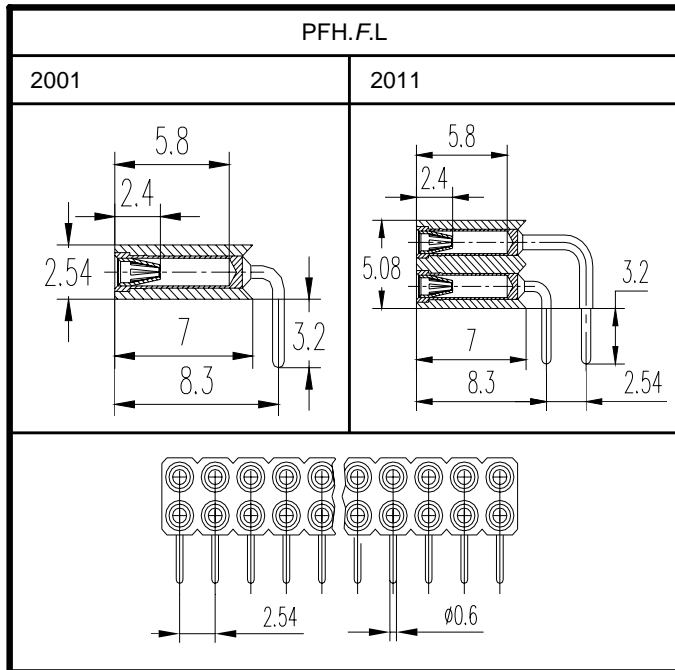

Pin style		PFH.F.L
Plating Sleeve (pin)		5.0µm Tin
Plating contact (clip)		Au 24c flash
TYPE	NP Nbr PIN	ORDERING NUMBERS
2001	36 50 (*1)	2001.NP.SP.F.L.0
2011	72 100 (*2)	2011.NP.SP.F.L.0

\*1) Availability from 1 to 50 contacts  
\*2) Availability from 2 to 100 contacts

PLATING OPTIONS	
Sleeve (pin), change letter F (5.0µm standard Tin) by:	
➤ .C	0.25µm gold plating
➤ .O	gold flash
➤ .D	tin / lead non-RoHS
Contact (clip), change suffix 0 (standard Au 24c flash) by:	
➤ .1	0.25µm average Au
➤ .4	0.75µm minimum 24c Au (MIL STD)
➤ .6	5.0µm tin
➤ .00	5.0µm tin / lead non-RoHS

### TECHNICAL DATA

<b>Temperature range</b>	-55°C to +125°C
<b>Insulator body</b>	Glass filled thermoplastic polyester, self-extinguishing, rated UL94V-0 PCB = standard PCT = high temperature (order with H) Example: 2001H28.PFH.F.L.0
<b>Outer shell (sleeve)</b>	Screw machined Brass CuZn36Pb3 (C36000)
<b>Inner spring contact SC6.065</b>	Stamped and formed BeCu (C17200) gold or tin plated, accepts Ø0.65-0.85 or rectangular pin 0.65 x 0.65
<b>Insertion / Extraction</b>	Per line Other forces available upon request.

Standard SC6.065	
Insertion	100g max.
Extraction	30g min.

**Other hard forces available upon request**  
Insertion max 375gr and extraction min 100gr.  
To order with hard force add letter V after the L instead of the mark.  
Example: 2001.50.PFH.F.LV0

**Other mating pin available upon request**  
To order with inner spring type SC4 (insertion Ø0.40-0.56) or SC6.VLI (insertion Ø0.40-0.56), add letter A (SC4) or B (SC6.VLI) after L instead of the mark. For insertion Ø0.95-1.05, add letter I.  
Examples: 2001.50.PFH.F.LA0 or 2001.50.PFH.F.LI0  
A, B and I available only for straight type.

### ELECTRICAL DATA

<b>Rated current</b>	3A
<b>Maxi working voltage</b>	100V <sub>RMS</sub> / 150 V <sub>dc</sub>
<b>Contact resistance</b>	10 mΩ max
<b>Dielectric strength</b>	1000 V <sub>RMS</sub> min

PCB 2.54mm pitch / Sockets /  
Mating pin 0.47mm / 0.76mm / 1mm / Strip /  
Height 7mm / Surface mount

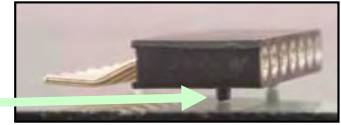
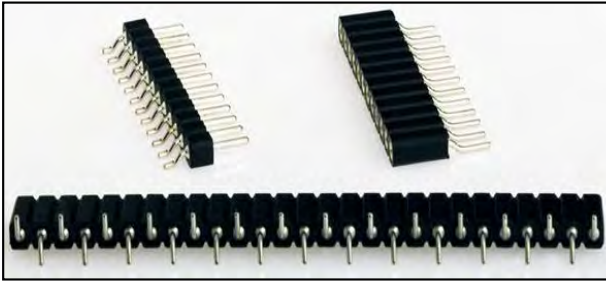

With locating pegs

PFH.SMV		PFH.SMH	PFH.SMHP
2001	2011	2001	2001

Available with Positioning options  
(see GUIDE AND PAD description page 29)

Pin style		PFH.SMV / PFH.SMH / PFH.SMHP
Plating Sleeve (pin)		5.0µm Tin
Plating contact (clip)		Au 24c flash
TYPE	NP Nbr PIN	ORDERING NUMBERS
2001	36 50 (*1)	2001HNP.PFH.SMV.F.0
2011	72 100 (*2)	2011HNP.PFH.SMV.F.0
2001	36 50 (*3)	2001HNP.PFH.SMH.F.0
2001	48 (*4)	2001HNP.PFH.SMHP.F.0

- \*1) Availability from 3 to 50 contacts
- \*2) Availability from 4 to 100 contacts
- \*3) Availability from 1 to 50 contacts
- \*4) Availability from 1 to 48 contacts

## PLATING OPTIONS

Sleeve (pin), change letter F (5.0µm standard Tin) by:

- .C 0.25µm gold plating
- .O gold flash
- .D tin / lead non-RoHS

Contact (clip), change suffix 0 (standard Au 24c flash) by:

- .1 0.25µm average Au
- .4 0.75µm minimum 24c Au (MIL STD)
- .6 5.0µm tin
- .00 5.0µm tin / lead non-RoHS

## TECHNICAL DATA

<b>Temperature range</b>	-55°C to +125°C
<b>Insulator body</b>	Glass filled thermoplastic polyester, self-extinguishing, rated UL94V-0 PCT = high temperature
<b>Outer shell (sleeve)</b>	Screw machined Brass CuZn36Pb3 (C36000)
<b>Inner spring contact SC6.065</b>	Stamped and formed BeCu (C17200) gold or tin plated, accepts Ø0.65-0.85 or rectangular pin 0.65 x 0.65
<b>Insertion / Extraction</b>	Per line Other forces available upon request.

### Standard SC6.065

Insertion	100g max.
Extraction	30g min.

### Other hard forces available upon request

Insertion max 375gr and extraction min 100gr.

To order with hard force add letter V after the F instead of the mark.

Example: 2001H50.PFH.SMV.FV0

### Other mating pin available upon request

To order with inner spring type SC4 (insertion Ø0.40-0.56) or SC6.VLI (insertion Ø0.40-0.56), add letter A (SC4) or B (SC6.VLI) after L instead of the mark. For insertion Ø0.95-1.05, add letter I.

Examples: 2001.50.PFH.SMV.FA0 or 2001.50.PFH.SMV.FI0

A, B and I available only for SMV type.

## ELECTRICAL DATA

<b>Rated current</b>	3A
<b>Maxi working voltage</b>	100V <sub>RMS</sub> / 150 V <sub>dc</sub>
<b>Contact resistance</b>	10 mΩ max
<b>Dielectric strength</b>	1000 V <sub>RMS</sub> min

PCB 2.54mm pitch / Sockets / Solder tail /  
Wire-wrap / Mating pin 0.47mm / 0.76mm / 1mm /  
Strip / Height 4.2mm

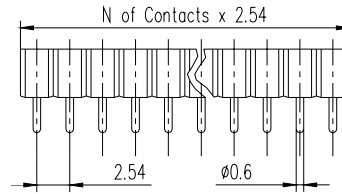
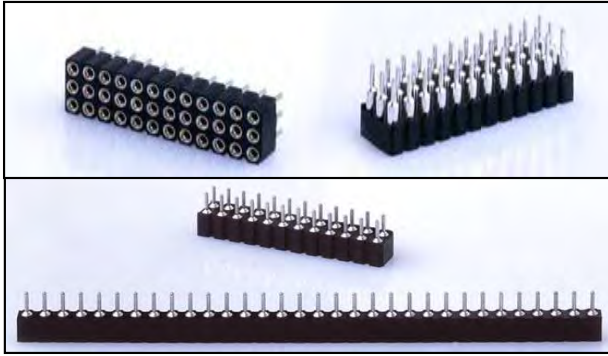

## PFH

3001	3011	3111	3211

Pin style		PFH
Plating Sleeve (pin)		5.0µm Tin
Plating contact (clip)		Au 24c flash
TYPE	NP Nbr PIN	ORDERING NUMBERS
3001	14 20 32 (*1)	3001.NP.PFH.F.0
3011	64 (*2)	3011.NP.PFH.F.0
3111	96 (*3)	3111.NP.PFH.F.0
3211	96 (*3)	3211.NP.PFH.F.0

\*1) Availability from 1 to 32 contacts  
\*2) Availability from 4 to 64 contacts  
\*3) Availability from 9 to 96 contacts

## TECHNICAL DATA

<b>Temperature range</b>	-55°C to +125°C
<b>Insulator body</b>	Glass filled thermoplastic polyester, self-extinguishing, rated UL94V-0 PCB = standard PCT = high temperature (order with H) Example: 3001H28.PFH.F.0
<b>Outer shell (sleeve)</b>	Screw machined Brass CuZn36Pb3 (C36000)
<b>Inner spring contact SC6.065</b>	Stamped and formed BeCu (C17200) gold or tin plated, accepts Ø0.65-0.85 or rectangular pin 0.65 x 0.65
<b>Insertion / Extraction</b>	Per line Other forces available upon request.

Standard SC6.065	
Insertion	100g max.
Extraction	30g min.

### Other hard forces available upon request

Insertion max 375gr and extraction min 100gr.  
To order with hard force add letter V after the F instead of the mark.  
Example: 3001.50.PFH.FV0

### Other mating pin available upon request

To order with inner spring type SC4 (insertion Ø0.40-0.56) or SC6.VLI (insertion Ø0.40-0.56), add letter A (SC4) or B (SC6.VLI) after L instead of the mark. For insertion Ø0.95-1.05, add letter I.  
Examples: 3001.50.PFH.FA0 or 3001.50.PFH.FI0

## PLATING OPTIONS

Sleeve (pin), change letter F (5.0µm standard Tin) by:

- .C 0.25µm gold plating
- .O gold flash
- .D tin / lead non-RoHS

Contact (clip), change suffix 0 (standard Au 24c flash) by:

- .1 0.25µm average Au
- .4 0.75µm minimum 24c Au (MIL STD)
- .6 5.0µm tin
- .00 5.0µm tin / lead non-RoHS

## ELECTRICAL DATA

<b>Rated current</b>	3A
<b>Maxi working voltage</b>	100V <sub>RMS</sub> / 150 V <sub>dc</sub>
<b>Contact resistance</b>	10 mΩ max
<b>Dielectric strength</b>	1000 V <sub>RMS</sub> min



PCB 2.54mm pitch / Sockets / Solder tail /  
Wire-wrap / Mating pin 0.47mm / 0.76mm / 1mm /  
Strip / Height 2.9mm

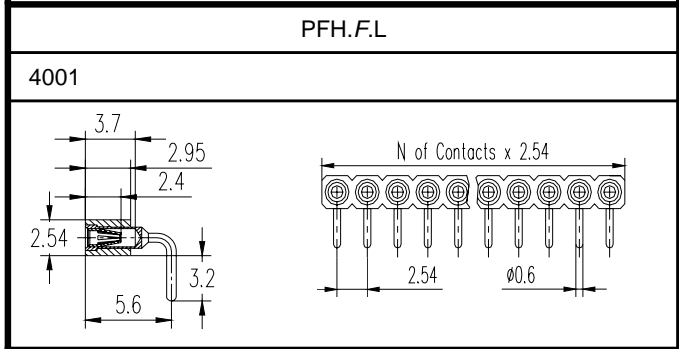
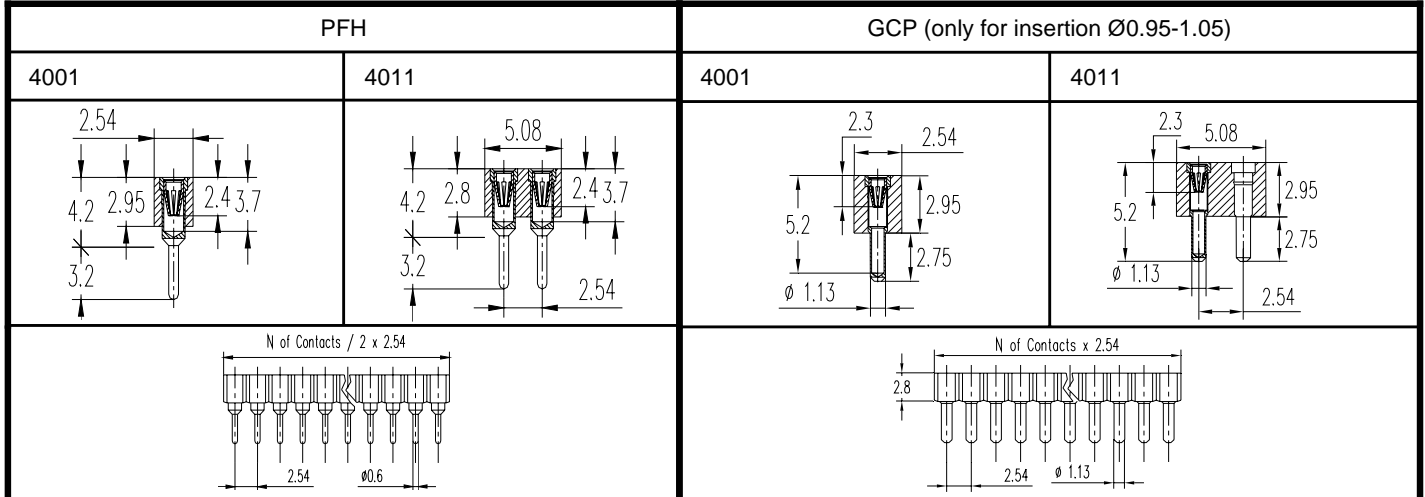
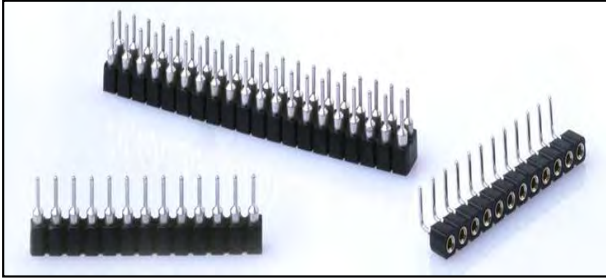

Pin style		PFH / PFH.F.L / GCP
Plating Sleeve (pin)		5.0µm Tin
Plating contact (clip)		Au 24c flash
TYPE	NP Nbr PIN	ORDERING NUMBERS
4001	64 (*1)	4001.NP.PFH.F.0
4011	64 (*2)	4011.NP.PFH.F.0
4001	64 (*1)	4001.NP.PFH.F.L.0

\*1) Availability from 1 to 64 contacts  
\*2) Availability from 4 to 72 contacts

**PLATING OPTIONS**

Sleeve (pin), change letter F (5.0µm standard Tin) by:

- .C 0.25µm gold plating
- .O gold flash
- .D tin / lead non-RoHS

Contact (clip), change suffix 0 (standard Au 24c flash) by:

- .1 0.25µm average Au
- .4 0.75µm minimum 24c Au (MIL STD)
- .6 5.0µm tin
- .00 5.0µm tin / lead non-RoHS

**TECHNICAL DATA**

**Temperature range** -55°C to +125°C

**Insulator body** Glass filled thermoplastic polyester, self-extinguishing, rated UL94V-0  
PCB = standard  
PCT = high temperature (order with H)  
Example: 4001H28.PFH.F.0

**Outer shell (sleeve)** Screw machined Brass CuZn36Pb3 (C36000)

**Inner spring contact SC6.065** Stamped and formed BeCu (C17200) gold or tin plated, accepts Ø0.65-0.85 or rectangular pin 0.65 x 0.65

**Insertion / Extraction** Per line  
Other forces available upon request.

Standard SC6.065	
Insertion	100g max.
Extraction	30g min.

**Other hard forces available upon request**  
Insertion max 375gr and extraction min 100gr.  
To order with hard force add letter V after the F instead of the mark.  
Example: 4001.50.PFH.FV0

**Other mating pin available upon request**  
To order with inner spring type SC4 (insertion Ø0.40-0.56) or SC6.VLI (insertion Ø0.40-0.56), add letter A (SC4) or B (SC6.VLI) after L instead of the mark. For insertion Ø0.95-1.05, add letter I.  
Examples: 4001.50.PFH.FA0 or 4001.50.PFH.FI0  
A, B and I available only for straight type.

**ELECTRICAL DATA**

**Rated current** 3A

**Maxi working voltage** 100V<sub>RMS</sub> / 150 V<sub>dc</sub>

**Contact resistance** 10 mΩ max

**Dielectric strength** 1000 V<sub>RMS</sub> min

PCB 2.54mm pitch / Sockets /  
Mating pin 0.47mm / 0.76mm / Strip /  
Height 2.9mm / Surface mount

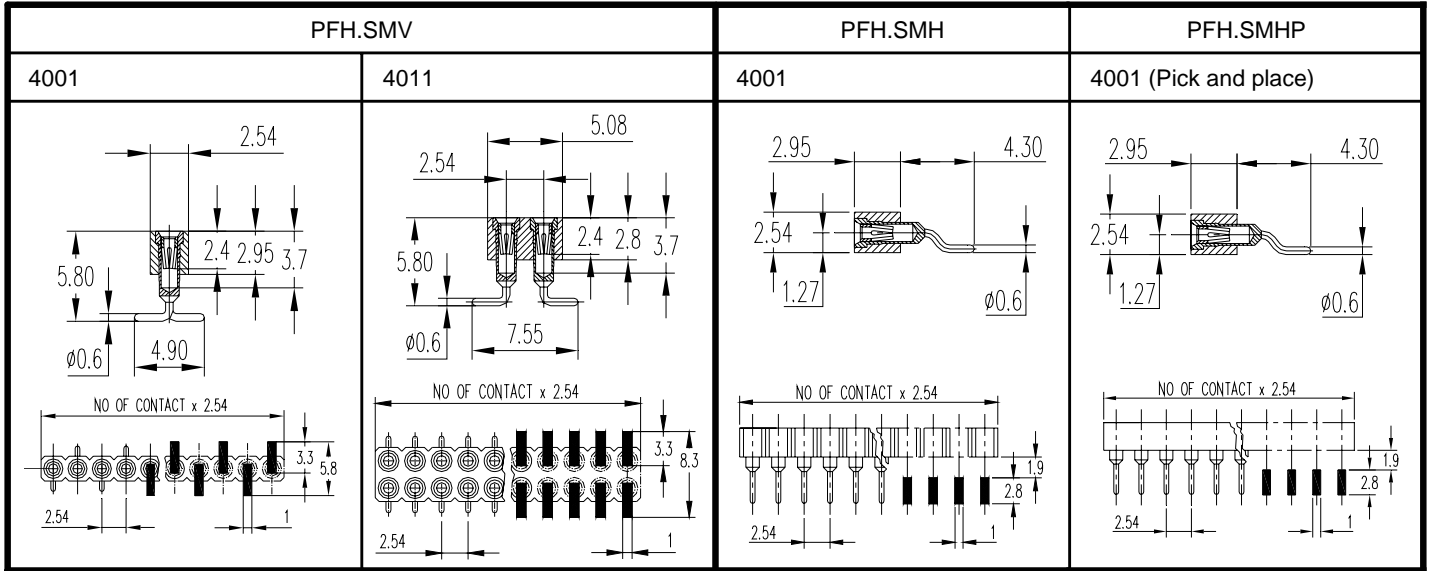
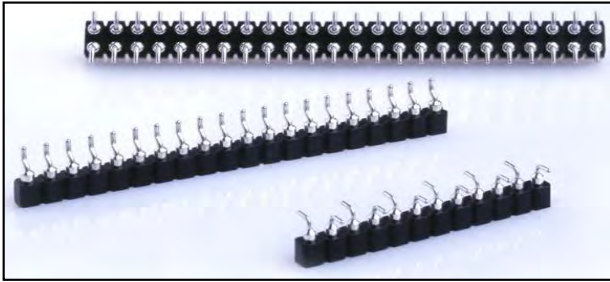

Pin style		PFH.SMV / PFH.SMH / PFH.SMHP
Plating Sleeve (pin)		5.0µm Tin
Plating contact (clip)		Au 24c flash
TYPE	NP Nbr PIN	ORDERING NUMBERS
4001	64 (*1)	4001HNP.PFH.SMV.F.0
4011	40 72 (*2)	4011HNP.PFH.SMV.F.0
4001	64 (*3)	4001HNP.PFH.SMH.F.0
4001	4/ (*4)	4001HNP.PFH.SMHP.F.0

Available with Positioning options  
(see GUIDE AND PAD description page 29)

- \*1) Availability from 3 to 50 contacts
- \*2) Availability from 4 to 72 contacts
- \*3) Availability from 1 to 64 contacts
- \*4) Availability from 1 to 48 contacts

PLATING OPTIONS	
Sleeve (pin), change letter F (5.0µm standard Tin) by:	
➤ .C	0.25µm gold plating
➤ .O	gold flash
➤ .D	tin / lead non-RoHS
Contact (clip), change suffix 0 (standard Au 24c flash) by:	
➤ .1	0.25µm average Au
➤ .4	0.75µm minimum 24c Au (MIL STD)
➤ .6	5.0µm tin
➤ .00	5.0µm tin / lead non-RoHS

TECHNICAL DATA	
Temperature range	-55°C to +125°C
Insulator body	Glass filled thermoplastic polyester, self-extinguishing, rated UL94V-0 PCT = high temperature
Outer shell (sleeve)	Screw machined Brass CuZn36Pb3 (C36000)
Inner spring contact SC6.065	Stamped and formed BeCu (C17200) gold or tin plated, accepts Ø0.65-0.85 or rectangular pin 0.65 x 0.65
Insertion / Extraction	Per line

Standard SC6.065	
Insertion	100g max.
Extraction	30g min.

ELECTRICAL DATA	
Rated current	3A
Maxi working voltage	100V <sub>RMS</sub> / 150 V <sub>dc</sub>
Contact resistance	10 mΩ max
Dielectric strength	1000 V <sub>RMS</sub> min

PCB 2.54mm pitch / Sockets / Solder tail /  
Wire-wrap / Mating pin 0.47mm / 0.76mm / 1mm /  
Strip / Height 8mm and 8.5mm

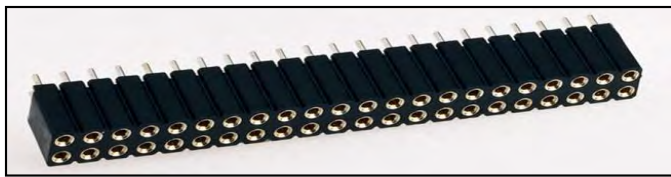
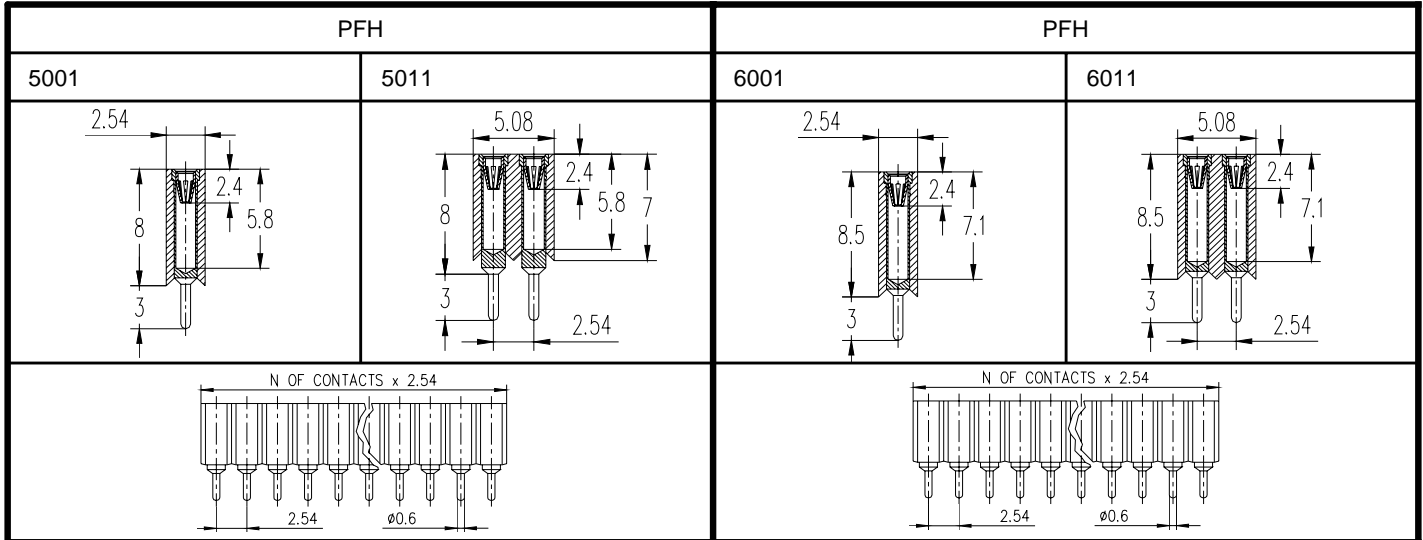
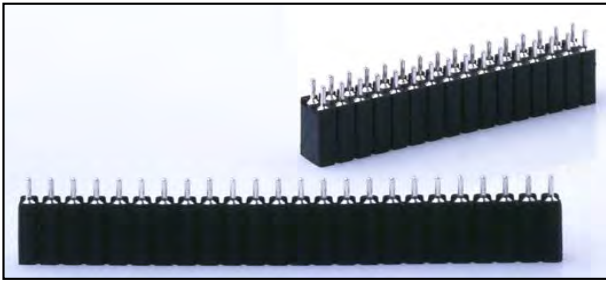

Pin style		PFH
Plating Sleeve (pin)		5.0µm Tin
Plating contact (clip)		Au 24c flash
TYPE	NP Nbr PIN	ORDERING NUMBERS
5001	36 (*1)	5001.NP.PFH.F.0
5011	72 100 (*2)	5011.NP.PFH.F.0
6001	36 (*1)	6001.NP.PFH.F.0
6011	72 100 (*2)	6011.NP.PFH.F.0

\*1) Availability from 1 to 36 contacts  
\*2) Availability from 4 to 100 contacts

## PLATING OPTIONS

Sleeve (pin), change letter F (5.0µm standard Tin) by:

- .C 0.25µm gold plating
- .O gold flash
- .D tin / lead non-RoHS

Contact (clip), change suffix 0 (standard Au 24c flash) by:

- .1 0.25µm average Au
- .4 0.75µm minimum 24c Au (MIL STD)
- .6 5.0µm tin
- .00 5.0µm tin / lead non-RoHS

## TECHNICAL DATA

**Temperature range** -55°C to +125°C  
**Insulator body** Glass filled thermoplastic polyester, self-extinguishing, rated UL94V-0  
 PCB = standard  
 PCT = high temperature (order with H)  
 Example: 5001H36.PFH.F.0  
**Outer shell (sleeve)** Screw machined Brass CuZn36Pb3 (C36000)  
**Inner spring contact SC6.065** Stamped and formed BeCu (C17200) gold or tin plated, accepts Ø0.65-0.85 or rectangular pin 0.65 x 0.65  
**Insertion / Extraction** Per line  
 Other forces available upon request.

Standard SC6.065	
Insertion	100g max.
Extraction	30g min.

### Other hard forces available upon request

Insertion max 375gr and extraction min 100gr.  
 To order with hard force add letter V after the F instead of the mark.  
 Example: 6001.50.PFH.FV0

### Other mating pin available upon request

To order with inner spring type SC4 (insertion Ø0.40-0.56) or SC6.VLI (insertion Ø0.40-0.56), add letter A (SC4) or B (SC6.VLI) after L instead of the mark. For insertion Ø0.95-1.05, add letter I.  
 Examples: 5001.36.PFH.FA0 or 6011.100.PFH.FI0

## ELECTRICAL DATA

**Rated current** 3A  
**Maxi working voltage** 100V<sub>RMS</sub> / 150 V<sub>dc</sub>  
**Contact resistance** 10 mΩ max  
**Dielectric strength** 1000 V<sub>RMS</sub> min



## SERIES 7001,7011

PCB 2.54mm pitch / Sockets / Solder tail /  
Wire-wrap / Mating pin 0.47mm / 0.76mm / 1mm /  
Strip / Height xx

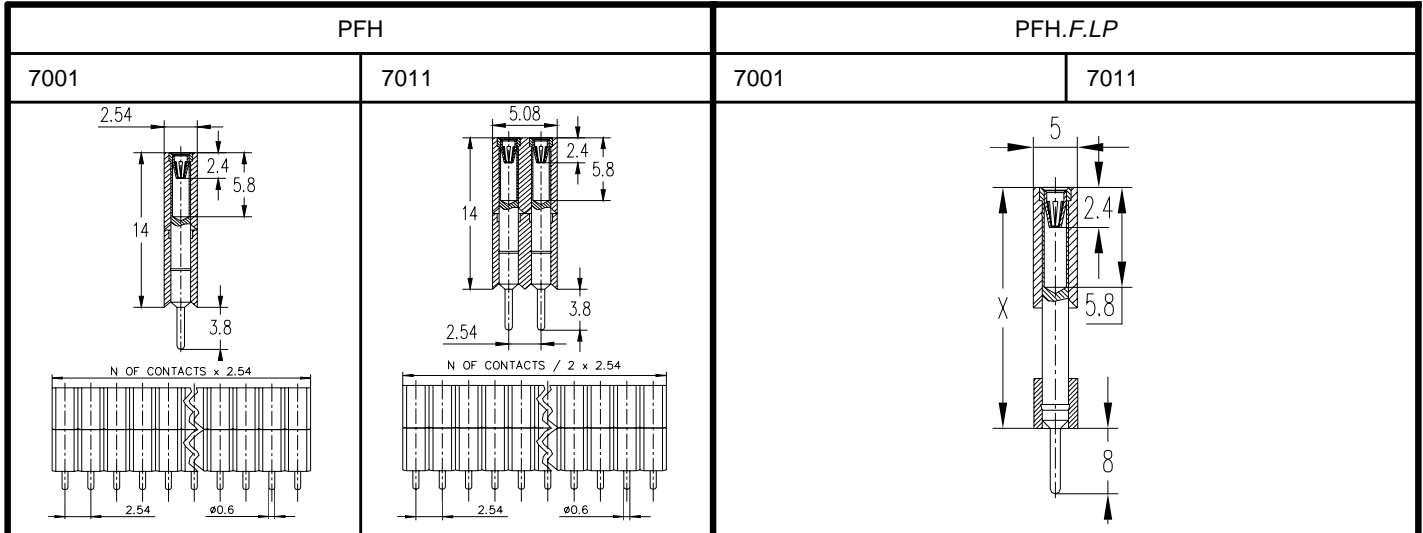

**LP PIN LENGTH X (in mm)**  
Other pin length X upon request

14.0	17.0	-	-	-	-
------	------	---	---	---	---

Pin style		PFH / PFH.F.LP
Plating Sleeve (pin)		5.0µm Tin
Plating contact (clip)		Au 24c flash
TYPE	NP Nbr PIN	ORDERING NUMBERS
7001	50 (*1)	7001.NP.PFH.F.0.LP
7011	72 100 (*2)	7011.NP.PFH.F.0.LP

\*1) Availability from 1 to 50 contacts

\*2) Availability from 4 to 72 contacts or 100 contacts (according to the LP)

### PLATING OPTIONS

Sleeve (pin), change letter F (5.0µm standard Tin) by:

- .C 0.25µm gold plating
- .O gold flash
- .D tin / lead non-RoHS

Contact (clip), change suffix 0 (standard Au 24c flash) by:

- .1 0.25µm average Au
- .4 0.75µm minimum 24c Au (MIL STD)
- .6 5.0µm tin
- .00 5.0µm tin / lead non-RoHS

### TECHNICAL DATA

<b>Temperature range</b>	-55°C to +125°C
<b>Insulator body</b>	Glass filled thermoplastic polyester, self-extinguishing, rated UL94V-0 PCB = standard PCT = high temperature (order with H) Example: 7001H36.PFH.F.0.14
<b>Outer shell (sleeve)</b>	Screw machined Brass CuZn36Pb3 (C36000)
<b>Inner spring contact SC6.065</b>	Stamped and formed BeCu (C17200) gold or tin plated, accepts Ø0.65-0.85 or rectangular pin 0.65 x 0.65
<b>Insertion / Extraction</b>	Per line Other forces available upon request.

Standard SC6.065

Insertion	100g max.
Extraction	30g min.

#### Other hard forces available upon request

Insertion max 375gr and extraction min 100gr.

To order with hard force add letter V after the F instead of the mark.

Example: 7001.50.PFH.FV0.14

#### Other mating pin available upon request







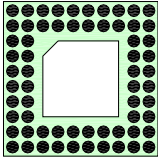
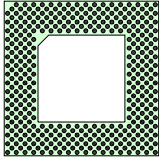
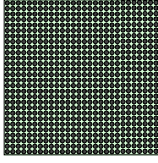
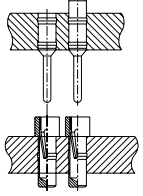
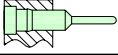
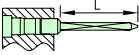
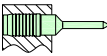
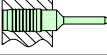
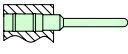

To order with inner spring type SC4 (insertion Ø0.40-0.56) or SC6.VLI (insertion Ø0.40-0.56), add letter A (SC4) or B (SC6.VLI) after L instead of the mark. For insertion Ø0.95-1.05, add letter I.

Examples: 7001.36.PFH.FA0.17 or 7011.100.PFH.FI0.14

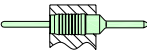
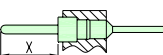
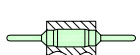
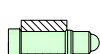
### ELECTRICAL DATA

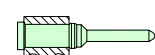
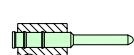
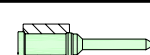
<b>Rated current</b>	3A
<b>Maxi working voltage</b>	100V <sub>RMS</sub> / 150 V <sub>dc</sub>
<b>Contact resistance</b>	10 mΩ max
<b>Dielectric strength</b>	1000 V <sub>RMS</sub> min

## PGA

SERIES		PGA 700 / 701	PGA 703 / 705	PGA 704	BGA 706 / 707 / 709
		2.54mm pitch	2.54mm pitch Zig-zag	1.27mm pitch Chip saver	1.27, 1 or 1.5mm pitch
SP					
SOCKETS	CC				
	AA				
	NC		74		
	NCS		74		
	FH			78	79
	CCWT		74		
	CCST <i>floating</i>		74		
HEADERS	ME		74		
	TT			78	
	AD				79
	BD				79
BALLS	BE				79
	BF				79
	BG				79
	BH				79
	BK				79
	BI				79
	BJ				79

You can choose almost all the headers and sockets of Series 610 and 2002 (2.54mm pitch)  
Please contact the customer service.

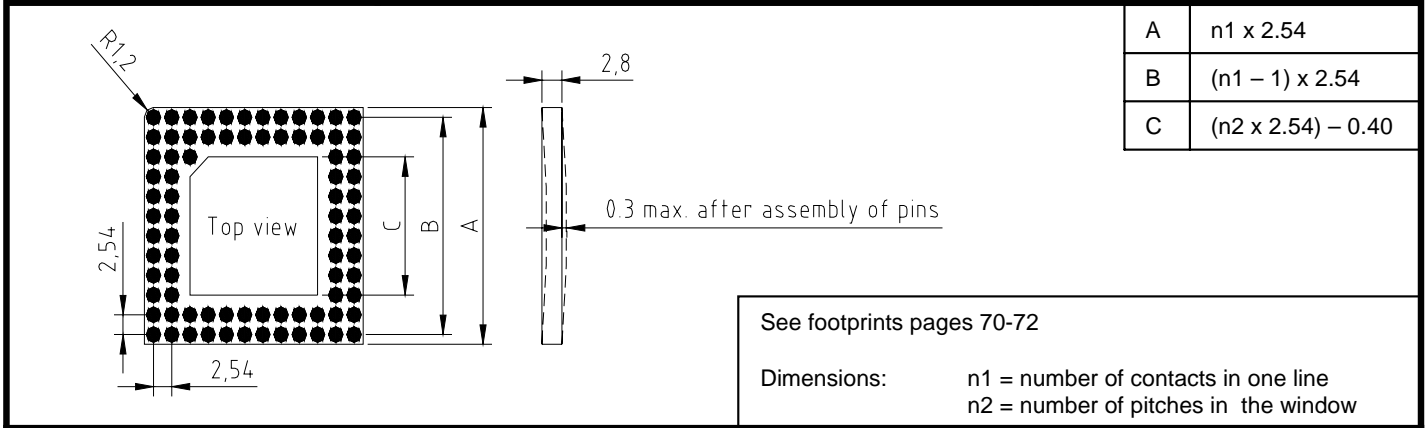
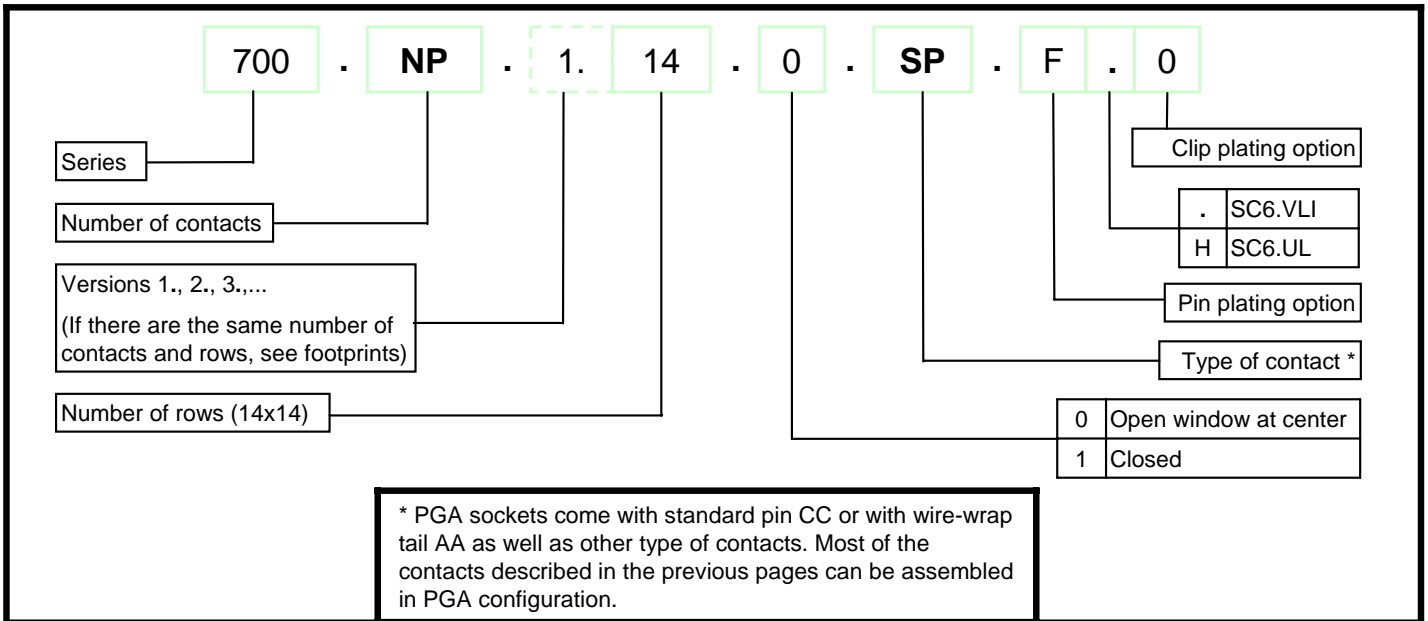

### PLATING OPTIONS

Sleeve (pin), change letter F (5.0µm standard Tin) by:

- .C 0.25µm gold plating
- .O gold flash
- .D tin / lead non-RoHS

Contact (clip), change suffix 0 (standard Au 24c flash) by:

- .1 0.25µm average Au
- .2 0.50µm average Au
- .3 0.75µm average Au
- .4 0.75µm minimum 24c Au (MIL STD)
- .6 5.0µm tin
- .00 5.0µm tin / lead non-RoHS

### TECHNICAL DATA

**Temperature range** -55°C to +125°C

**Insulator body** Glass filled thermoplastic polyester, self-extinguishing, rated UL94V-0  
PCT = série 700  
Epoxy FR-4 = série 701

**Outer shell (sleeve)** Screw machined Brass CuZn36Pb3 (C36000)

**Inner spring contact SC6.VLI** Stamped and formed BeCu (C17200) gold or tin plated, accepts Ø0.40-0.56 or rectangular pin 0.25 x 0.45

**Insertion / Extraction** Ø0.43 test pin (SC6.VLI) or Ø0.46 test pin (SC6.UL)  
Other forces available upon request.

SC6.VLI		SC6.UL	
Insertion	70g max.	Insertion	20g max.
Extraction	10g min.	Extraction	5g min.

### ELECTRICAL DATA

**Rated current** 1A

**Maxi working voltage** 100V<sub>RMS</sub> / 150 V<sub>dc</sub>

**Contact resistance** 10 mΩ max

**Dielectric strength** 1000 V<sub>RMS</sub> min

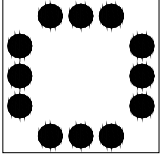
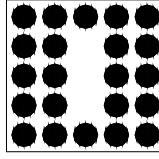
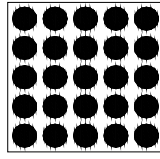
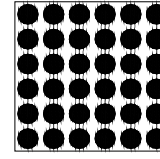
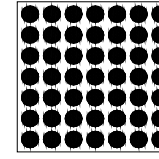
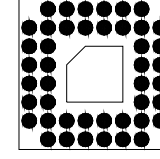
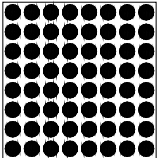
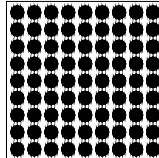
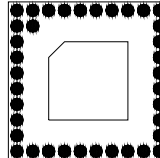
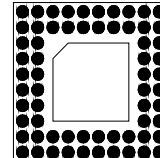
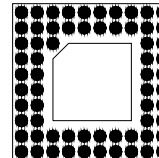
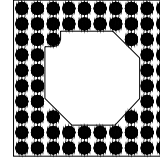
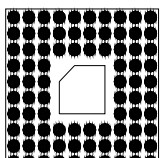
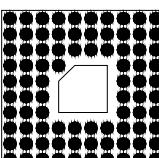
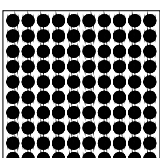
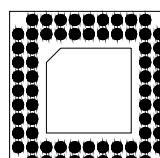
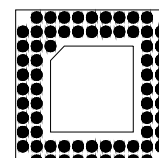
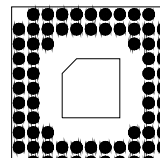
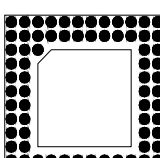
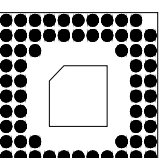
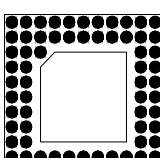
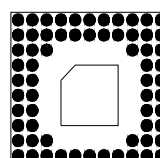
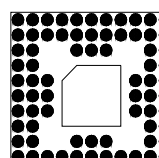
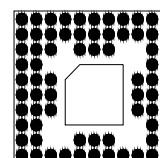
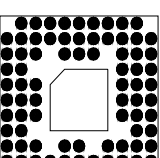
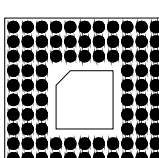
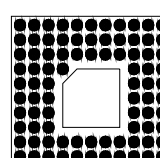
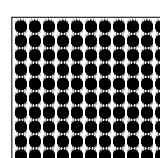
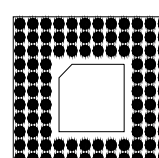
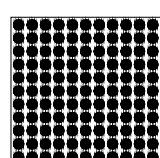
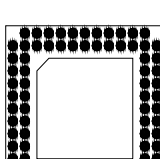
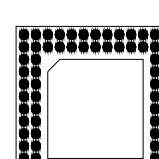
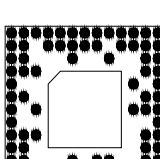
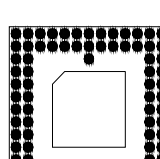
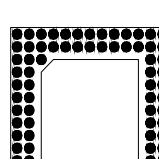
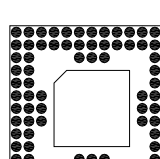

		5x5		6x6	7x7	8x8
						
700.012.5.1.SP.F.0		700.022.5.1.SP.F.0		700.025.5.1.SP.F.0	700.036.6.1.SP.F.0	700.049.7.1.SP.F.0
8x8		9x9	10x10			
						
700.064.8.1.SP.F.0		700.081.9.1.SP.F.0	700.037.10.0.SP.F.0	700.064.10.0.SP.F.0	700.065.10.0.SP.F.0	700.068.10.0.SP.F.0
10x10			11x11			
						
700.084.10.0.SP.F.0		700.085.10.0.SP.F.0	700.100.10.1.SP.F.0	700.068.11.0.SP.F.0	700.069.11.0.SP.F.0	700.072.1.11.0.SP.F.0
11x11						
						
700.072.2.11.0.SP.F.0		700.073.1.11.0.SP.F.0	700.073.2.11.0.SP.F.0	700.076.11.0.SP.F.0	700.084.11.0.SP.F.0	700.085.1.11.0.SP.F.0
11x11			12x12			
						
700.085.2.11.1.SP.F.0		700.096.11.0.SP.F.0	700.097.11.0.SP.F.0	700.121.11.1.SP.F.0	700.108.12.0.SP.F.0	700.144.12.1.SP.F.0
13x13						
						
700.084.13.0.SP.F.0		700.088.1.13.0.SP.F.0	700.088.2.13.0.SP.F.0	700.089.13.0.SP.F.0	700.089.1.13.0.SP.F.0	700.100.13.0.SP.F.0

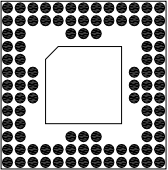
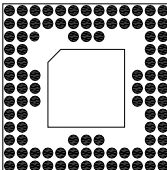
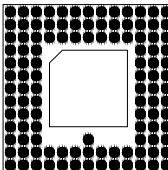
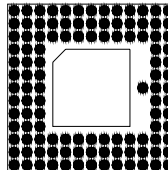
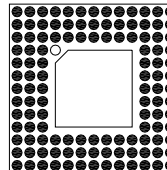
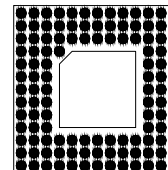
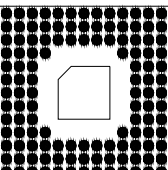
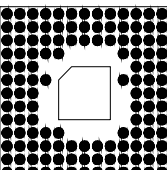
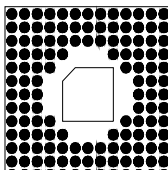
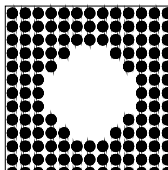
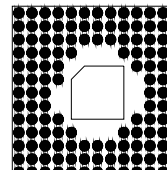
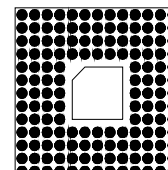
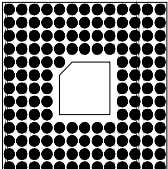
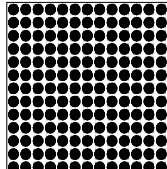
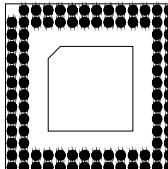
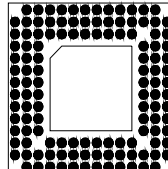
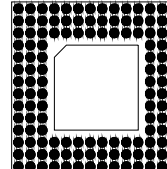
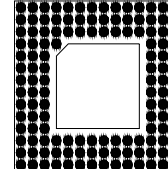
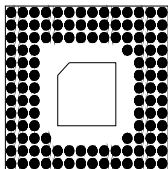
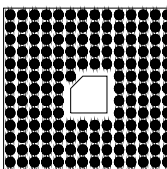
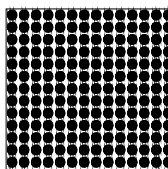
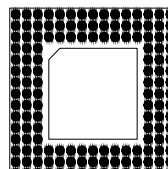
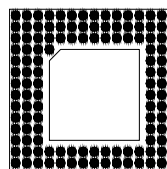
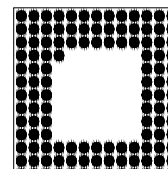
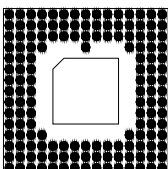
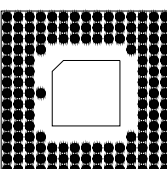
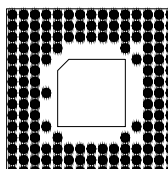
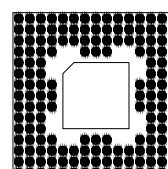
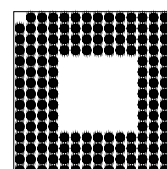
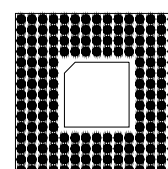
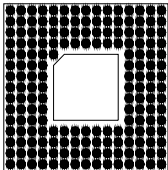
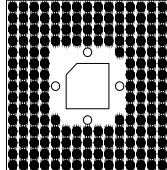
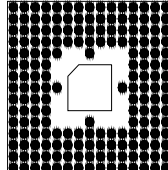
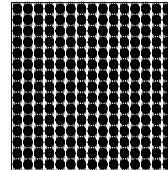
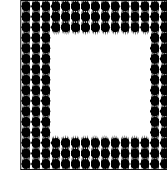
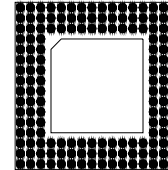
13x13					
					
700.100.2.13.0.SP.F.0	700.101.13.0.SP.F.0	700.114.1.13.0.SP.F.0	700.114.2.13.0.SP.F.0	700.120.13.0.SP.F.0	700.121.13.0.SP.F.0
13x13					
					
700.124.13.0.SP.F.0	700.128.13.0.SP.F.0	700.132.13.0.SP.F.0	700.132.13.1.SP.F.0	700.133.13.0.SP.F.0	700.144.13.0.SP.F.0
13x13			14x14		
					
700.145.13.0.SP.F.0	700.169.13.1.SP.F.0	700.095.14.0.SP.F.0	700.125.14.0.SP.F.0	700.132.14.0.SP.F.0	700.133.14.0.SP.F.0
14x14			15x15		
					
700.135.14.0.SP.F.0	700.181.14.0.SP.F.0	700.196.14.1.SP.F.0	700.144.15.0.SP.F.0	700.145.15.0.SP.F.0	700.145.15.1.SP.F.0
15x15					
					
700.149.1.15.0.SP.F.0	700.149.2.15.0.SP.F.0	700.153.15.0.SP.F.0	700.160.15.0.SP.F.0	700.175.15.1.SP.F.0	700.176.15.0.SP.F.0
15x15			16x16		
					
700.177.15.0.SP.F.0	700.179.15.0.SP.F.0	700.181.15.0.SP.F.0	700.225.15.1.SP.F.0	700.155.16.1.SP.F.0	700.156.16.0.SP.F.0

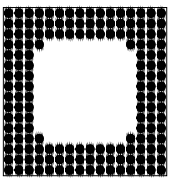
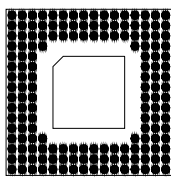
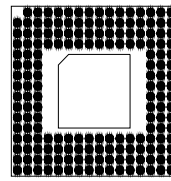
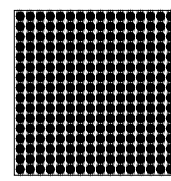
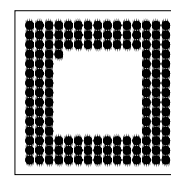
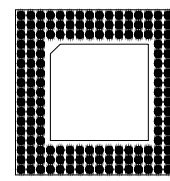
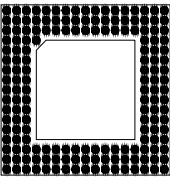
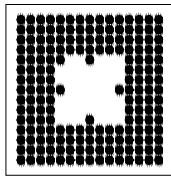
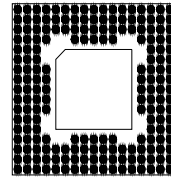
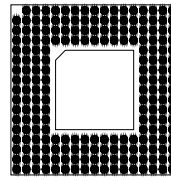
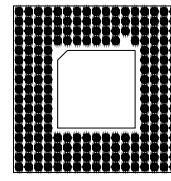
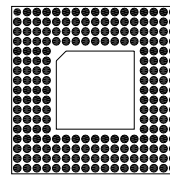
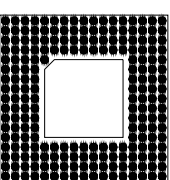
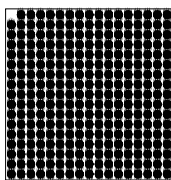
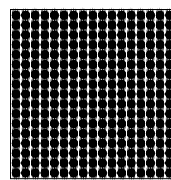
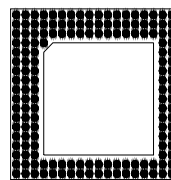
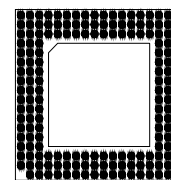
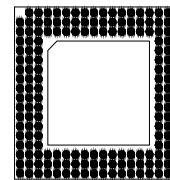
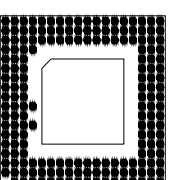
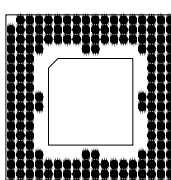
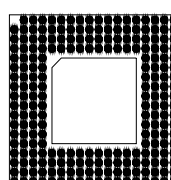
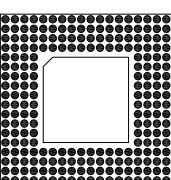
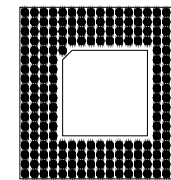
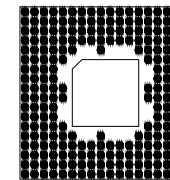
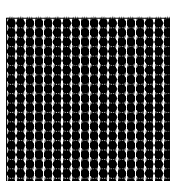
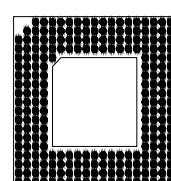
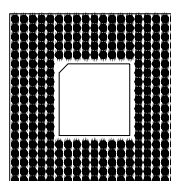
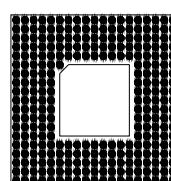
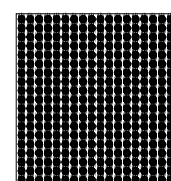
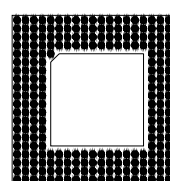
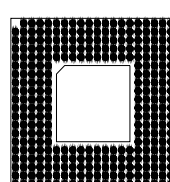
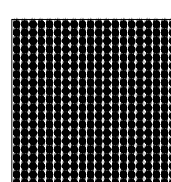
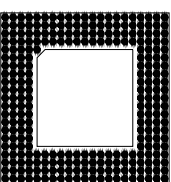
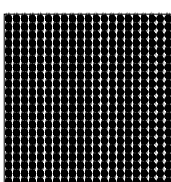
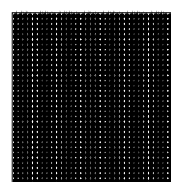
16x16				17x17	
					
700.159.16.1.SP.F.0	700.160.16.0.SP.F.0	700.175.16.0.SP.F.0	700.256.16.1.SP.F.0	700.145.17.1.SP.F.0	700.168.17.0.SP.F.0
17x17					
					
700.169.17.0.SP.F.0	700.181.17.1.SP.F.0	700.192.17.0.SP.F.0	700.207.1.17.0.SP.F.0	700.207.2.17.0.SP.F.0	700.208.17.0.SP.F.0
17x17			18x18		
					
700.209.17.0.SP.F.0	700.288.17.1.SP.F.0	700.289.17.1.SP.F.0	700.155.18.0.SP.F.0	700.179.1.18.0.SP.F.0	700.179.2.18.0.SP.F.0
18x18					
					
700.182.18.0.SP.F.0	700.191.18.0.SP.F.0	700.223.18.0.SP.F.0	700.224.18.0.SP.F.0	700.225.18.0.SP.F.0	700.241.18.0.SP.F.0
18x18	19x19				20x20
					
700.324.18.1.SP.F.0	700.238.19.0.SP.F.0	700.280.19.0.SP.F.0	700.281.19.0.SP.F.0	700.361.19.1.SP.F.0	700.257.20.0.SP.F.0
20x20		21x21		33x33	
					
700.299.20.0.SP.F.0	700.400.20.1.SP.F.0	700.273.21.0.SP.F.0	700.441.21.1.SP.F.0	701.1089.33.1.SP.F.0	

# DRAW YOUR OWN DESIGN

	1	2	3	4	5	6	7	8	9	10	11	12	13	14	15	16	17	18	19	20	21	
A	○	○	○	○	○	○	○	○	○	○	○	○	○	○	○	○	○	○	○	○	○	○
B	○	○	○	○	○	○	○	○	○	○	○	○	○	○	○	○	○	○	○	○	○	○
C	○	○	○	○	○	○	○	○	○	○	○	○	○	○	○	○	○	○	○	○	○	○
D	○	○	○	○	○	○	○	○	○	○	○	○	○	○	○	○	○	○	○	○	○	○
E	○	○	○	○	○	○	○	○	○	○	○	○	○	○	○	○	○	○	○	○	○	○
F	○	○	○	○	○	○	○	○	○	○	○	○	○	○	○	○	○	○	○	○	○	○
G	○	○	○	○	○	○	○	○	○	○	○	○	○	○	○	○	○	○	○	○	○	○
H	○	○	○	○	○	○	○	○	○	○	○	○	○	○	○	○	○	○	○	○	○	○
I	○	○	○	○	○	○	○	○	○	○	○	○	○	○	○	○	○	○	○	○	○	○
J	○	○	○	○	○	○	○	○	○	○	○	○	○	○	○	○	○	○	○	○	○	○
K	○	○	○	○	○	○	○	○	○	○	○	○	○	○	○	○	○	○	○	○	○	○
L	○	○	○	○	○	○	○	○	○	○	○	○	○	○	○	○	○	○	○	○	○	○
M	○	○	○	○	○	○	○	○	○	○	○	○	○	○	○	○	○	○	○	○	○	○
N	○	○	○	○	○	○	○	○	○	○	○	○	○	○	○	○	○	○	○	○	○	○
O	○	○	○	○	○	○	○	○	○	○	○	○	○	○	○	○	○	○	○	○	○	○
P	○	○	○	○	○	○	○	○	○	○	○	○	○	○	○	○	○	○	○	○	○	○
Q	○	○	○	○	○	○	○	○	○	○	○	○	○	○	○	○	○	○	○	○	○	○
R	○	○	○	○	○	○	○	○	○	○	○	○	○	○	○	○	○	○	○	○	○	○
S	○	○	○	○	○	○	○	○	○	○	○	○	○	○	○	○	○	○	○	○	○	○
T	○	○	○	○	○	○	○	○	○	○	○	○	○	○	○	○	○	○	○	○	○	○
U	○	○	○	○	○	○	○	○	○	○	○	○	○	○	○	○	○	○	○	○	○	○

Customer			
Address			
ZIP		City	
Country			
Phone			
Fax			
E-mail			

Series (700 or 701)	
Number of contacts	
Number of rows	
Open or Closed	
Type of contact (can be yours)	
Pin plating option	
Type of clip (can be yours)	
Clip plating option	

## PGA 700,701

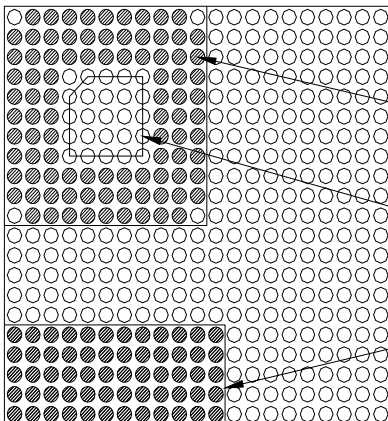

Mark positions where you want pins

Mark window

Odd shapes also possible

Fill in the holes where you want the contacts. If your request isn't standard, please send us a detailed drawing. For the very specific design, insulator is made in Epoxy, from 22x22 to 33x33.



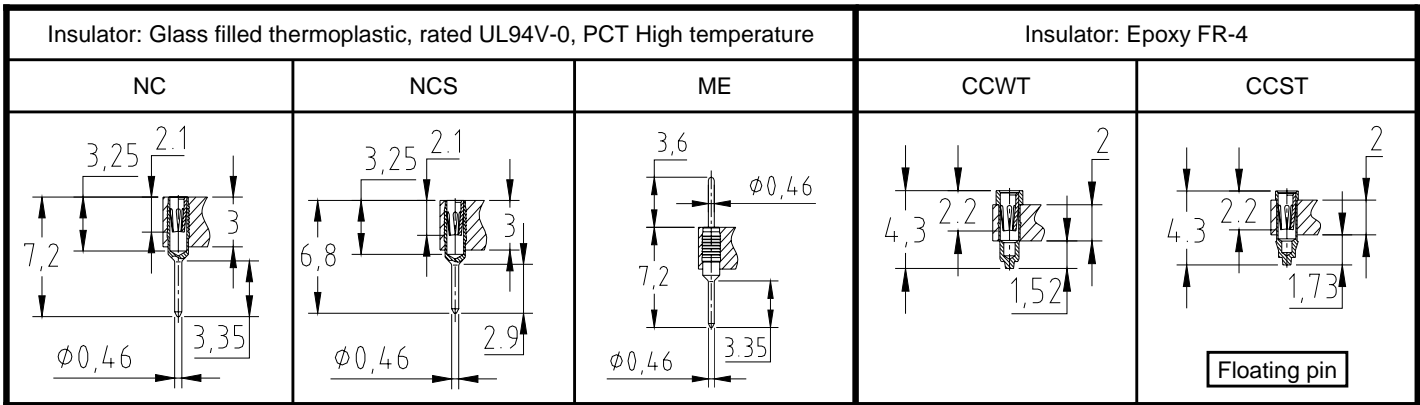
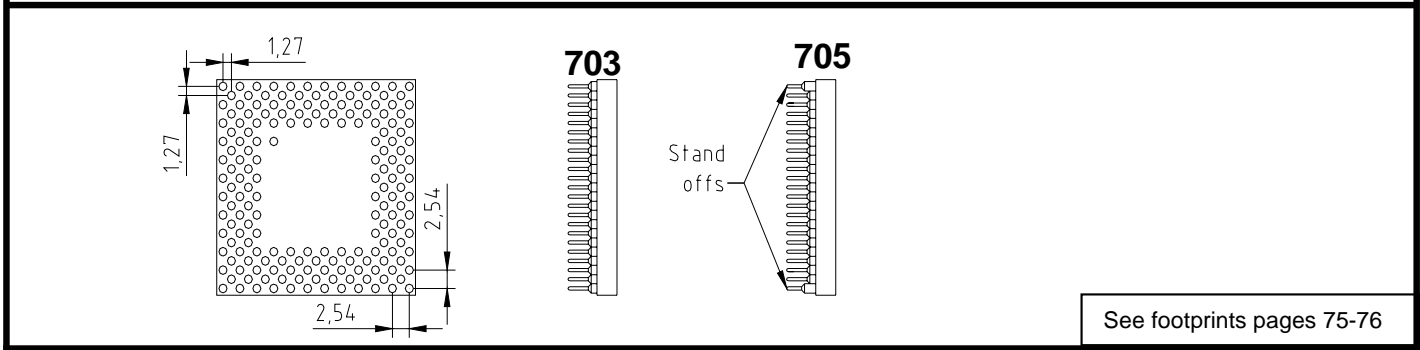
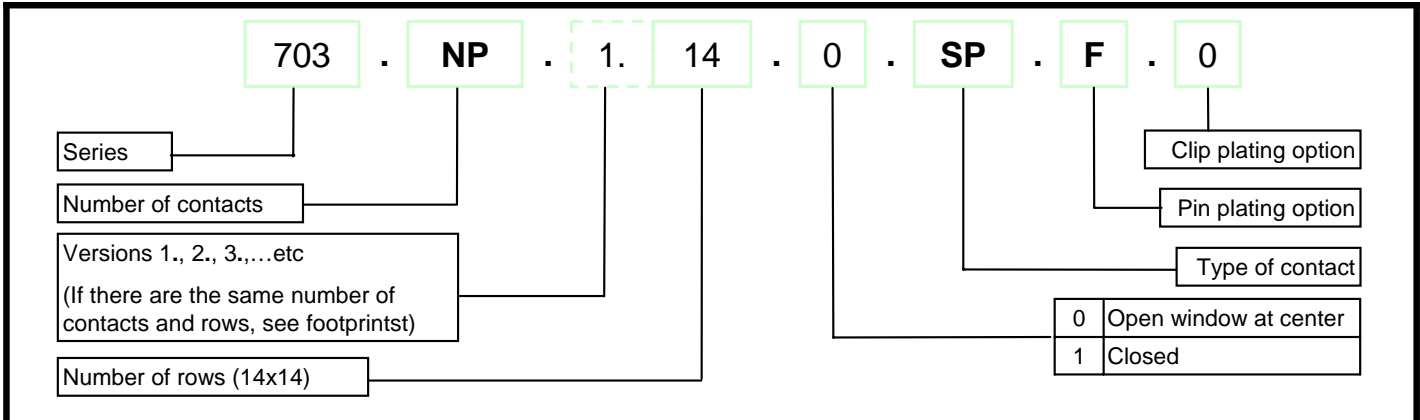

### PLATING OPTIONS

Sleeve (pin), change letter F (5.0µm standard Tin) by:

- .C 0.25µm gold plating
- .O gold flash
- .D tin / lead non-RoHS

Contact (clip), change suffix 0 (standard Au 24c flash) by:

- .1 0.25µm average Au
- .2 0.50µm average Au
- .3 0.75µm average Au
- .4 0.75µm minimum 24c Au (MIL STD)
- .6 5.0µm tin
- .00 5.0µm tin / lead non-RoHS

### TECHNICAL DATA

**Temperature range** -55°C to +125°C

**Outer shell (sleeve)** Screw machined Brass CuZn36Pb3 (C36000)

**Inner spring contact SC6.UL** Stamped and formed BeCu (C17200) gold or tin plated, accepts Ø0.35-0.50 or rectangular pin 0.25 x 0.45

**Insertion / Extraction** Ø0.46 test pin  
Other forces available upon request.

SC6.UL	
Insertion	20g max.
Extraction	5g min.

### ELECTRICAL DATA

**Rated current** 1A

**Maxi working voltage** 100V<sub>RMS</sub> / 150 V<sub>dc</sub>

**Contact resistance** 10 mΩ max

**Dielectric strength** 700 V<sub>RMS</sub> min

14x14			16x16	17x17		
703.183.14.0.SP.F.0	703.304.14.0.SP.F.0	703.365.14.1.SP.F.0	703.299.16.0.SP.F.0	703.321.17.0.SP.F.0	703.364.17.0.SP.F.0	
17x17		18x18				
703.365.17.0.SP.F.0	703.545.17.1.SP.F.0	703.280.18.0.SP.F.0	703.293.18.0.SP.F.0	703.305.18.0.SP.F.0	703.325.18.0.SP.F.0	
18x18					19x19	
703.361.18.0.SP.F.0	703.369.18.0.SP.F.0	703.391.18.0.SP.F.0	703.391.18.1.SP.F.0	703.431.18.0.SP.F.0	703.296.19.0.SP.F.0	
19x19						
703.320.19.0.SP.F.0	703.321.19.0.SP.F.0	703.370.1.19.0.SP.F.0	703.370.2.19.0.SP.F.0	703.372.19.0.SP.F.0	703.401.19.0.SP.F.0	
19x19						
703.403.19.0.SP.F.0	703.419.19.0.SP.F.0	703.420.19.0.SP.F.0	703.428.19.0.SP.F.0	703.429.19.0.SP.F.0	703.463.19.0.SP.F.0	
20x20			21x21			
703.411.20.0.SP.F.0	703.447.20.0.SP.F.0	703.539.20.0.SP.F.0	703.557.20.0.SP.F.0	703.475.21.0.SP.F.0	703.528.21.0.SP.F.0	

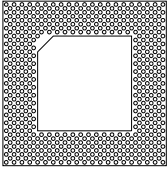
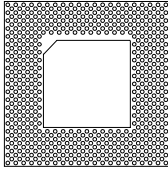
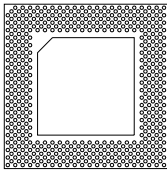
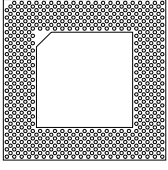
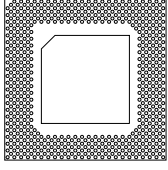
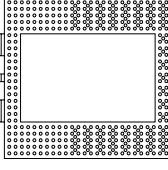

21x21		22x22		24x24	24x26
					
703.529.21.0.SP.F.0	703.565.20.0.SP.F.0	703.503.22.0.SP.F.0	703.559.22.0.SP.F.0	703.599.24.0.SP.F.0	703.387.24.0.SP.F.0

# DRAW YOUR OWN DESIGN

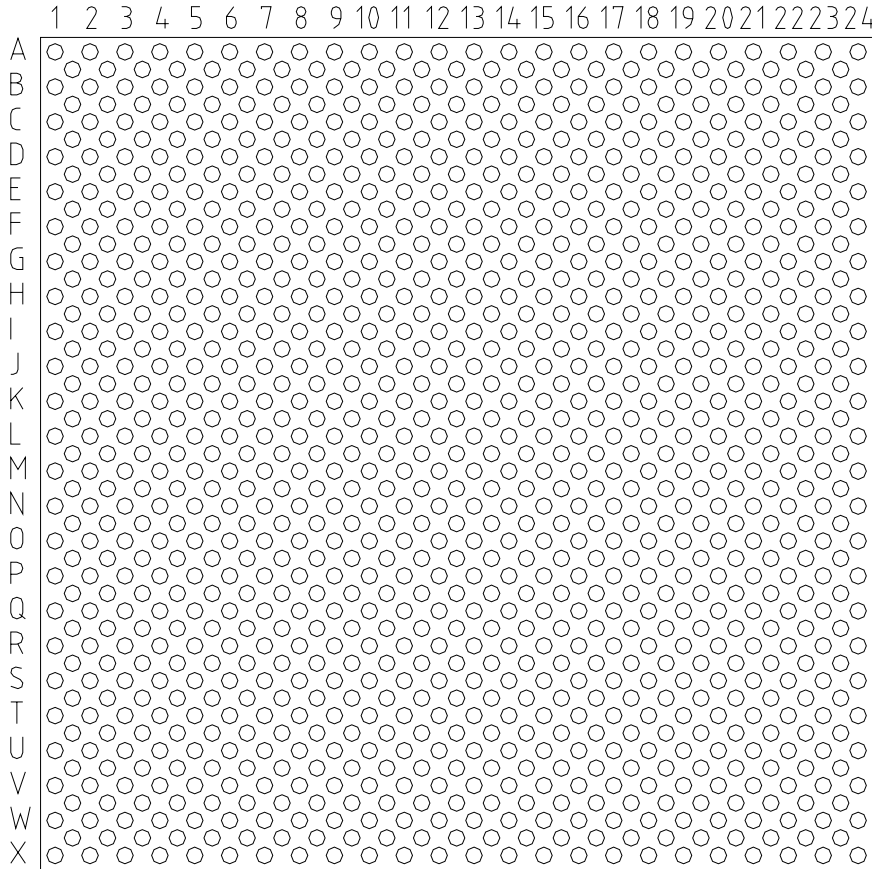

Customer			
Address			
ZIP		City	
Country			
Phone			
Fax			
E-mail			

Series (703 or 705)	
Number of contacts	
Number of rows	
Open or Closed	
Type of contact (can be yours)	
Pin plating option	
Type of clip (can be yours)	
Clip plating option	

## PGA 703,705

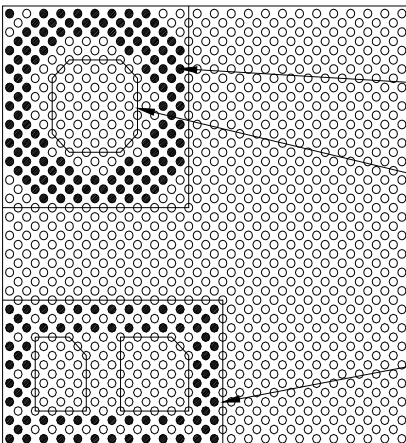

Mark positions where you want pins

Mark window

Odd shapes also possible

Fill in the holes where you want the contacts. If your request isn't standard, please send us a detailed drawing. For the very specific design, insulator is made in Epoxy, from 24x24 to 33x33 and more.

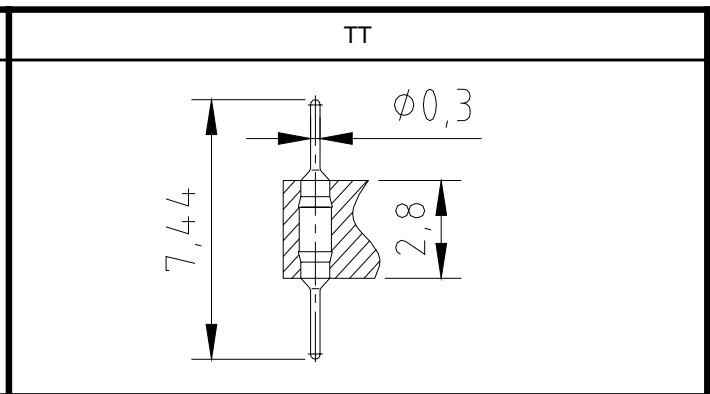
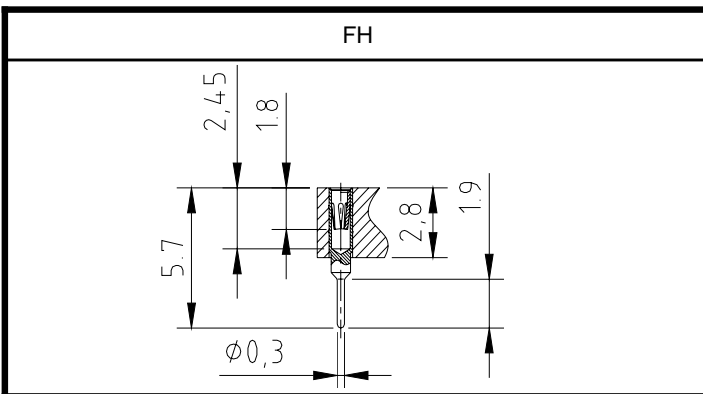
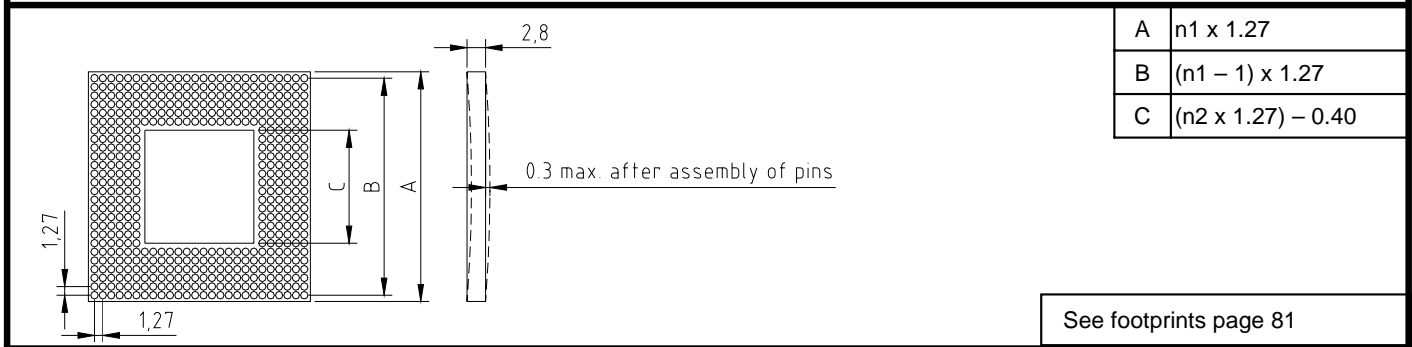
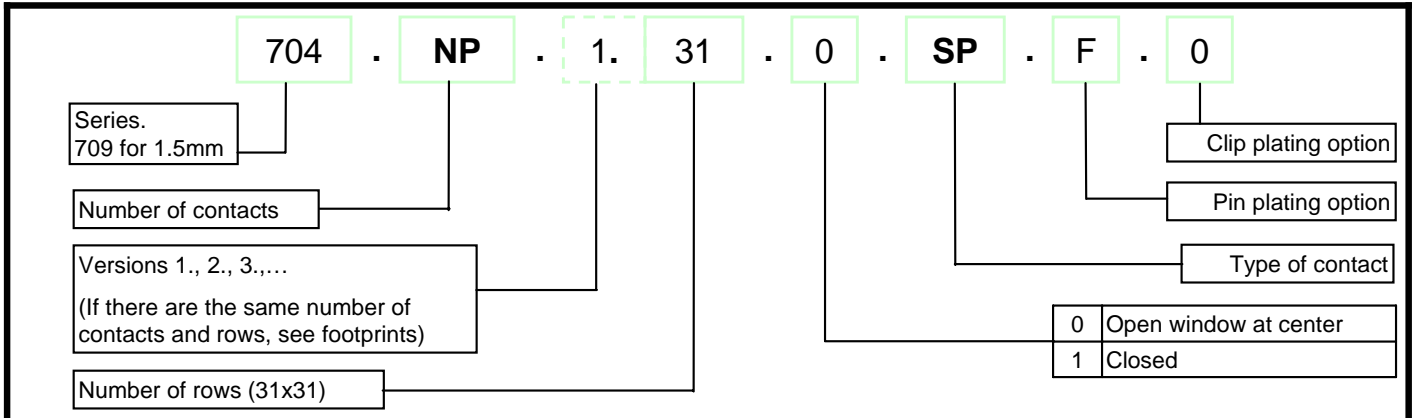

**PLATING OPTIONS**

Sleeve (pin), change letter F (5.0µm standard Tin) by:

- .C 0.25µm gold plating
- .O gold flash
- .D tin / lead non-RoHS

Contact (clip), change suffix 0 (standard Au 24c flash) by:

- .1 0.25µm average Au
- .2 0.50µm average Au
- .3 0.75µm average Au
- .4 0.75µm minimum 24c Au (MIL STD)
- .6 5.0µm tin
- .00 5.0µm tin / lead non-RoHS

**TECHNICAL DATA**

**Temperature range** -55°C to +125°C

**Outer shell (sleeve)** Screw machined Brass CuZn36Pb3 (C36000)

**Insulator body** Glass filled Epoxy FR-4

**Inner spring contact SC3** Stamped and formed BeCu (C17200) gold or tin plated, accepts Ø0.35-0.50 or rectangular pin 0.25 x 0.45

**Insertion / Extraction** Ø0.46 test pin  
Other forces available upon request.

SC3		SC4.SM	
Insertion	150g max.	Insertion	150g max.
Extraction	30g min.	Extraction	30g min.

**ELECTRICAL DATA**

**Rated current** 1A

**Maxi working voltage** 100V<sub>RMS</sub> / 150 V<sub>dc</sub>

**Contact resistance** 10 mΩ max

**Dielectric strength** 500 V<sub>RMS</sub> min

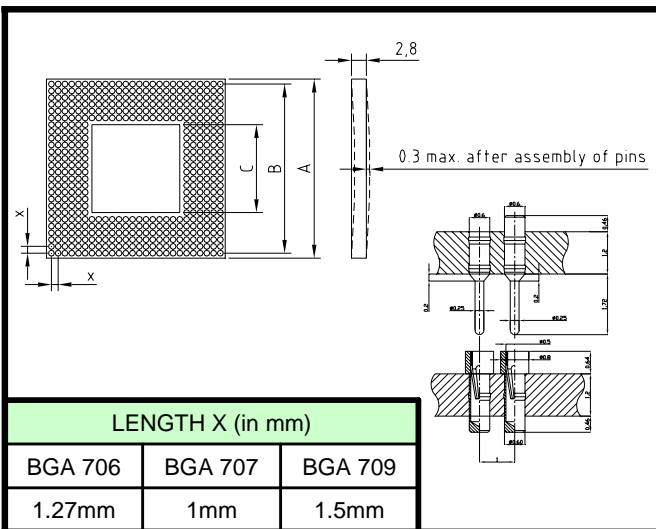
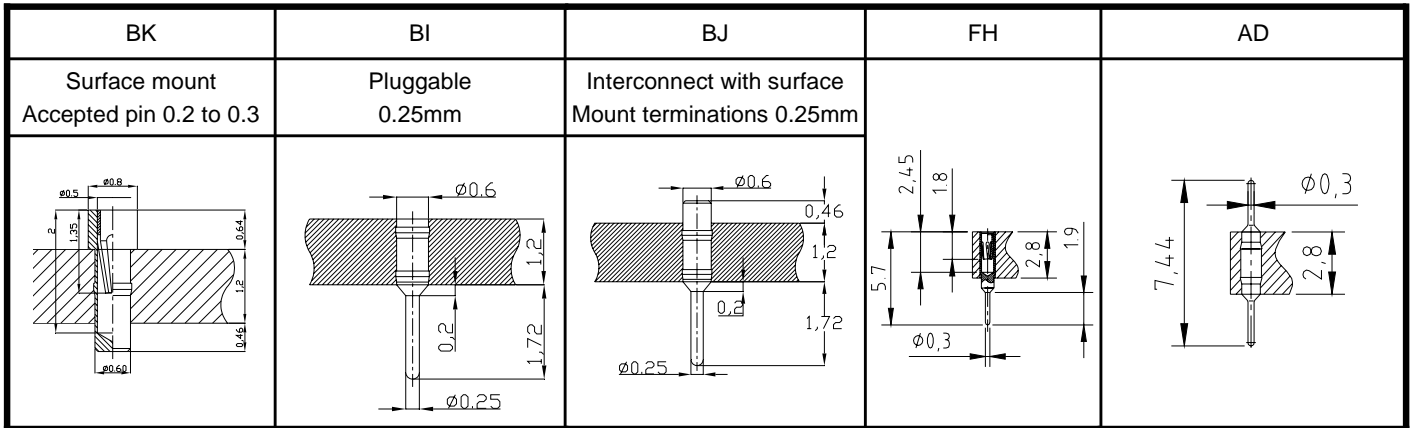
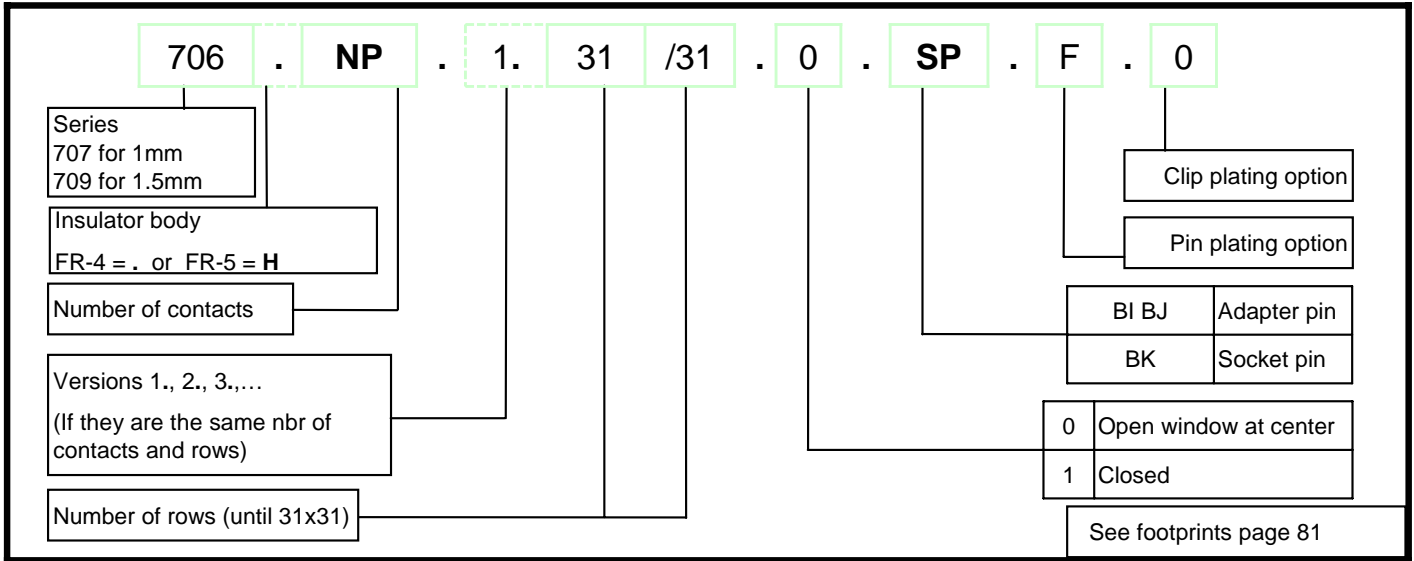

### PLATING OPTIONS

Sleeve (pin), change letter F (5.0µm standard Tin) by:

- .C 0.25µm gold plating
- .O gold flash
- .D tin / lead non-RoHS

---

Contact (clip), change suffix 0 (standard Au 24c flash) by:

- .1 0.25µm average Au
- .4 0.75µm minimum 24c Au (MIL STD)
- .6 5.0µm tin
- .00 5.0µm tin / lead non-RoHS

### TECHNICAL DATA

**Temperature range** -55°C to +125°C

**Outer shell (sleeve)** Screw machined Brass CuZn36Pb3 (C36000)

**Insulator body** Glass filled Epoxy FR-4 or FR-5 = High temperature (order with H front NP)

**Inner spring contact SC3.015** Stamped and formed BeCu (C17200) gold or tin plated, accepts Ø0.2-0.3 or rectangular pin 0.15 x 0.25

**Insertion / Extraction** Ø0.20 test pin  
Other forces available upon request.

SC3.015	
Insertion	30g max.
Extraction	10g min.

### ELECTRICAL DATA

<b>Rated current</b>	1A
<b>Maxi working voltage</b>	100V <sub>RMS</sub> / 150 V <sub>dc</sub>
<b>Contact resistance</b>	10 mΩ max
<b>Dielectric strength</b>	500 V <sub>RMS</sub> min

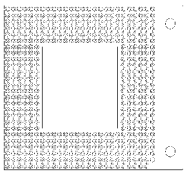
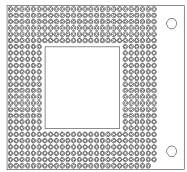
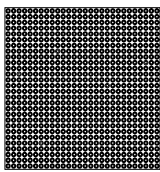
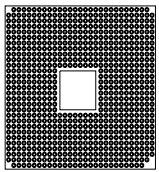
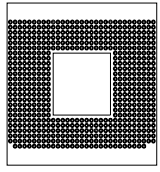
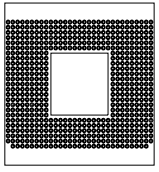
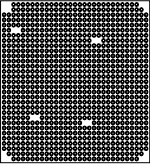
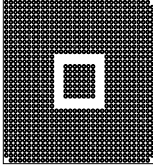
26x26		28x28	29x29	31x31	
					
704.478.26.0.SP.F.0	704.479.26.0.SP.F.0	704.700.28.1.SP.F.0	704.754.29.0.SP.F.0	704.603.31.0.SP.F.0	704.604.31.0.SP.F.0
31x31	33x33				
					
704.940.31.0.SP.F.0	704.1014.33.1.SP.F.0				

Other PGA gold BGA available on request.  
 Please draw your request on the following page or contact the  
 customer service.

## DRAW YOUR OWN DESIGN

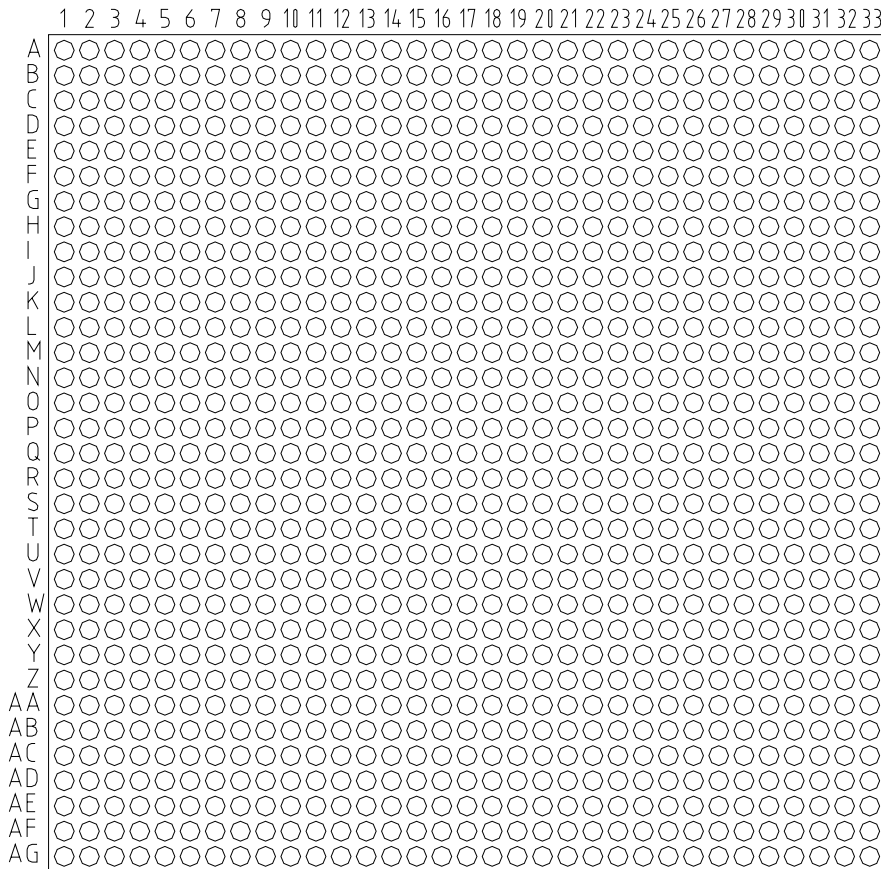

Customer			Series	
Address			(704, 706, 707 or 709)	
ZIP	City		Number of contacts	
Country			Number of rows	
Phone			Open or Closed	
Fax			Type of contact (can be yours)	
E-mail			Pin plating option	
			Type of clip (can be yours)	
			Clip plating option	

### BGA 704 and PGA 706,707,709

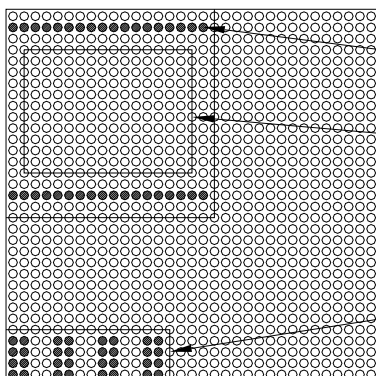

Mark positions where you want pins

Mark window

Odd shapes also possible

Fill in the holes where you want the contacts. If your request isn't standard, please send us a detailed drawing. For the very specific design, insulator is made in Epoxy, from 14x14 to 35x35 and more.



All Clips produced from BeCu(C17200) Alloy 172 1/2 HD and heat treated after forming.

Outside diameter A	Operating range diameter	Overall length mm B	Test pin diameter	Max. Insert. force grames	Withdrawal force grames		Min. mating pin length.	Min diameter Contact body E	Current rating	Number of fingers	Part number	Catalog reference
					MAXI	MINI						
0.5	0.15-0.28	1.35	0.2	30		10	1.60	0.70		3	SC3.015	Q
0.6	0.18-0.33	1.65	0.28	30		9	1.80	0.80		3	SC3.018	R
0.71	0.30-0.43	1.52	0.38	250		42	1.70	0.90	1A	6	SC6.03	S
0.79	0.30-0.48	1.52	0.38	60		15	1.70	1.00	1A	6	SC6.03L	T
0.81	0.35-0.5	1.9	0.46	140		35	2.10	1.00	2A	3	SC3	F
0.81	0.35-0.5	1.9	0.46	60		20	2.10	1.00	2A	3	SC3.L	G
0.81	0.35-0.5	1.7	0.46	145		30	1.90	1.00	2A	4	SC4.SM	E
1.11	0.40-0.56	2.1	0.43	320		50	2.70	1.40	3A	4	SC4	A
1.11	0.40-0.56	1.6	0.43	350		100	1.80	1.40	3A	4	SC4.SH	D
1.11	0.40-0.56	2.1	0.46	35		15	2.70	1.40	3A	4	SC4.SL	L
1.11	0.40-0.56	2.1	0.46	50		20	2.70	1.40	3A	4	SC4.VLI	M
1.11	0.40-0.56	2.1	0.46	15		5	2.70	1.40	3A	6	SC6.UL	H
1.11	0.40-0.56	2.1	0.46	50		20	2.70	1.40	3A	6	SC6.VLI	B
1.27	0.64-0.89	2.1	0.66	140		25	2.65	1.43	4A	6	SC6.065L	U
1.35	0,56-0,81	2.97	I-0,6 W-0,61	385		50	3.05	1.70	5A	4	SC4.056	CA
1.32	0.65-0.85	2	0.66	100		30	2.60	1.43	5A	6	SC6.065	C
1.32	0.65-0.85	2	0.66	375		100	2.60	1.43	5H	6	SC6.065H	V
1.39	0.94-1.1	1.65	1.01	160		50	2.00	1.80	8A	6	SC6.094	I
1.63	0,81-1,15	3.05	I-1,01 W-0,89	1020		110	3.30	1.90	8A	4	SC4.081H	
1.63	0,81-1,15	3.05	1.01	2270		200	3.30	1.90	8A	4	SC4.081SH	
1.63	0,81-1,17	3.05	0.99	420		140	3.60	1.90	8A	4	SC4.081	
1.75	0,91-1,27	3.81	1,01 0,76	325 55		60 15	3.95	2.00	8A	4	SC4.091	
1.73	1,01-1,27	2.16	1.015	300		75	2.30	1.90	8A	6	SC6.101	
2.03	1,01-1,5	3.81	I-1,27 W-1,01	375		35	3.95	2.30	10A	4	SC4.101	
2.23	1,21-1.62	3.15	I-1,524 W-1,27	400		60	3.40	2.60	11A	4	SC4.121	O
2.23	1,21-1.62	3.15	1.56			200	3.40	2.60	11A	4	SC4.121L	
2.75	1,65-2,08	3.75	I-1,88 W-1,83	1360		230	3.95	3.10	15A	4	SC4.165	OL
2.75	1,65-2,08	3.75	2	700		250	3.95		15A	4	SC4.165.L	P
3.14	2,13-2,6	3	2.36	600		150	3.15	3.60	15A	6	SC6.213	OA

This list is not exhaustive. You can find other stamped or screw-machined clips by asking the Customer service.

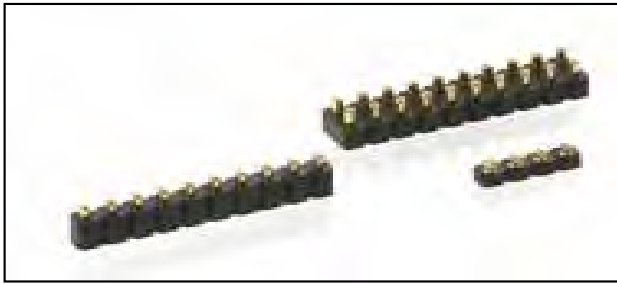

For other POGO PINS, please contact the customer service.

PP		
2002	2022	2502

AVAILABLE CONNECTOR HEIGHTS				
Type	Initial Height A (mm)	Stroke (mm)	Plastic Body Height B (mm)	LP
2502	4.5	1.15	2.95	4.5
2502	5	1.4	2.95	5
2502	5.5	1.4	2.95	5.5
2002 / 2022	6	1.4	4	6
2002 / 2022	6.5	1.4	4	6.5
2002 / 2022	7	1.4	4	7
2002 / 2022	7.5	1.4	4	7.5

Available with Positioning options  
(see GUIDE AND PAD description page 29)

Pin style		PP
TYPE	NP Nbr PIN	ORDERING NUMBERS
2002	2 to 10	2002HNP.PP.LP.II
2022	4 to 20	2022HNP.PP.LP.II
2502	2 to 10	2502HNP.PP.LP.II

**PLATING OPTIONS**  
➤ .II 0.5µm gold plating (barrel and piston)

TECHNICAL DATA	
<b>Temperature range</b>	-55°C to +125°C
<b>Insulator body</b>	Glass filled thermoplastic polyester, self-extinguishing, rated UL94V-0 PCT = high temperature
<b>Barrel and Piston</b>	Screw machined Brass CuZn36Pb3 (C36000)
<b>Spring</b>	Stainless steel X12 CrNi177, DIN 17224
<b>Max. stroke</b>	1.4mm
<b>Forces</b>	0.25 N initial / 0.6 N at ½ stroke
<b>Mechanical life</b>	100'000 cycles
<b>Examples PN</b>	2002H02.PP.6.II or 2502H10.PP.5.II

ELECTRICAL DATA	
<b>Operating current</b>	3.5A max
<b>Contact resistance</b>	15 mΩ (static measurement, alway position)

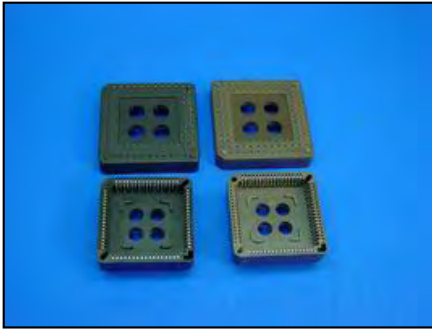

**PLCC SMT**

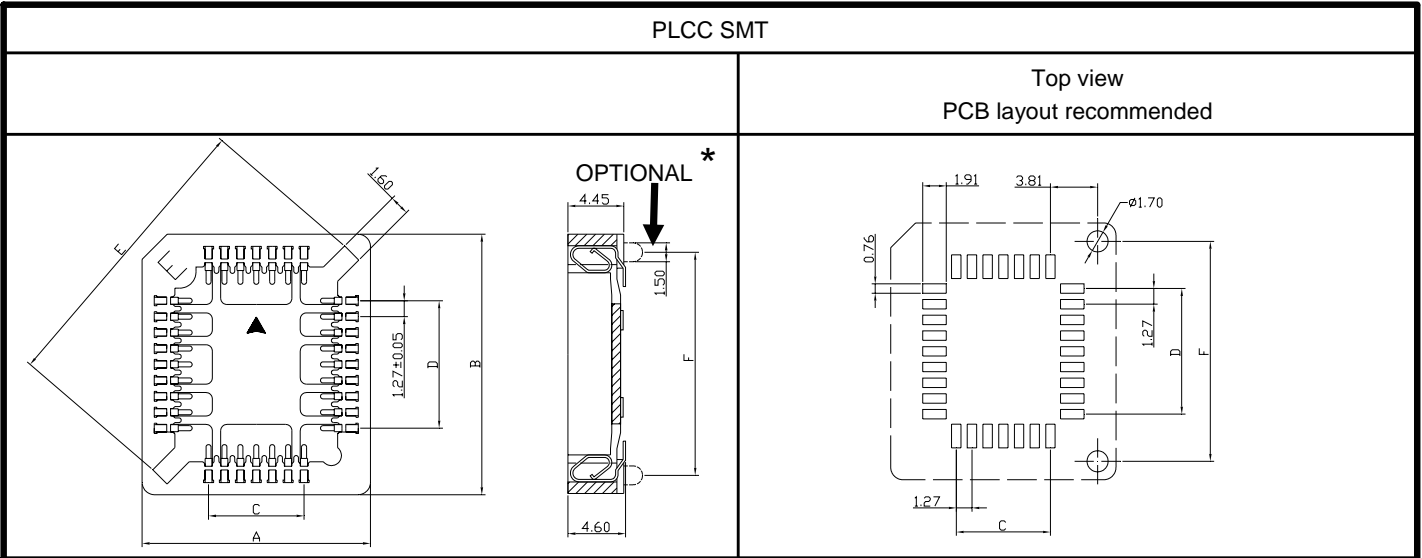

\* If you want a guide, add lettre P after SMT and before TR.  
 Examples: D-PLCCA084TFSMTP  
 D-PLCCA044TFSMTPTR

**TABLE OF DIMENSIONS**

D-PLCCA0XXTFSMT Replace XX by the number of contacts. Example: D-PLCCA052TFSMT	No of contacts	A	B	C	D	E	F
	20	15.58	15.58	5.08	5.08	16.85	12.70
28	18.12	18.12	7.62	7.62	20.45	15.24	
32	18.12	20.66	7.62	10.16	22.15	17.78	
44	23.20	23.20	12.70	12.70	27.50	20.32	
52	25.74	25.74	15.24	15.24	31.20	22.86	
68	30.82	30.82	20.32	20.32	38.35	27.94	
84	35.90	35.90	25.40	25.40	45.55	33.02	

**PACKAGING OPTIONS**

Tube                      Standard  
                                  Example: D-PLCCA068TFSMT

Tape & Reel            Add TR at the end  
                                  Example: D-PLCCA032TFSMTTR

Please contact the customer service for availability

**TECHNICAL DATA**

**Temperature range**      -55°C to +105°C  
**Housing**                      PPS UL94V-0  
**Contact**                      Copper Alloy  
**Plating**                        Tin  
**IR reflow soldering temperature:**  
**RoHS part**                    260°C, 5Sec

**ELECTRICAL DATA**

**Rated current**              1A  
**Maxi working voltage**    100V<sub>RMS</sub> / 150 V<sub>dc</sub>  
**Contact resistance**        30 mΩ max  
**Insulation resistance**     1000 mΩ max  
**Dielectric strength**        500 V<sub>RMS</sub> min

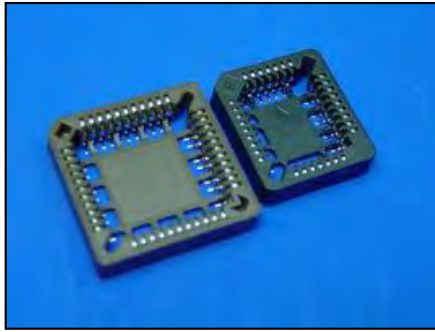

**PLCC SOLDER TAIL**

Top view  
PCB layout recommended

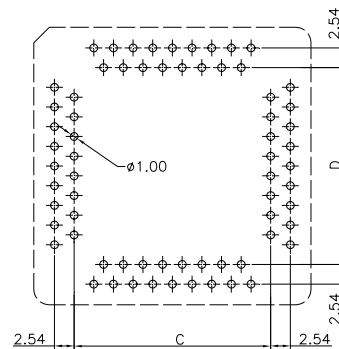
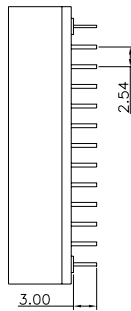
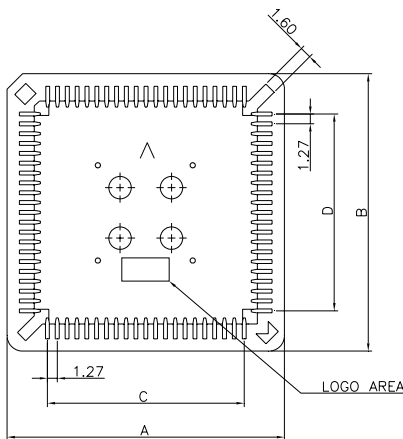

**TABLE OF DIMENSIONS**

D-PLCCA0XXTFANS Replace XX by the number of contacts. Example: D-PLCCA052TFANS	No of contacts	A $\pm 0.2$	B $\pm 0.2$	C $\pm 0.1$	D $\pm 0.1$
	20	15.50	15.50	5.08	5.08
	28	18.04	18.04	7.62	7.62
	32	18.04	20.54	7.62	10.16
	44	23.48	23.48	12.70	12.70
	52	25.88	25.88	15.24	15.24
	68	31.04	31.04	20.32	20.32
	84	36.04	36.04	25.40	25.40

**TECHNICAL DATA**

Temperature range	-40°C to +105°C
Housing	PPS UL94V-0
Contact	Copper Alloy
Plating	Tin

**ELECTRICAL DATA**

Rated current	1A
Maxi working voltage	100V <sub>RMS</sub> / 150 V <sub>dc</sub>
Contact resistance	20 mΩ max
Insulation resistance	1000 mΩ max
Dielectric strength	600 V <sub>RMS</sub> min

**PACKAGING OPTIONS**

Tube	Standard Example: D-PLCCA068TFANS
------	--------------------------------------







# Switzerland

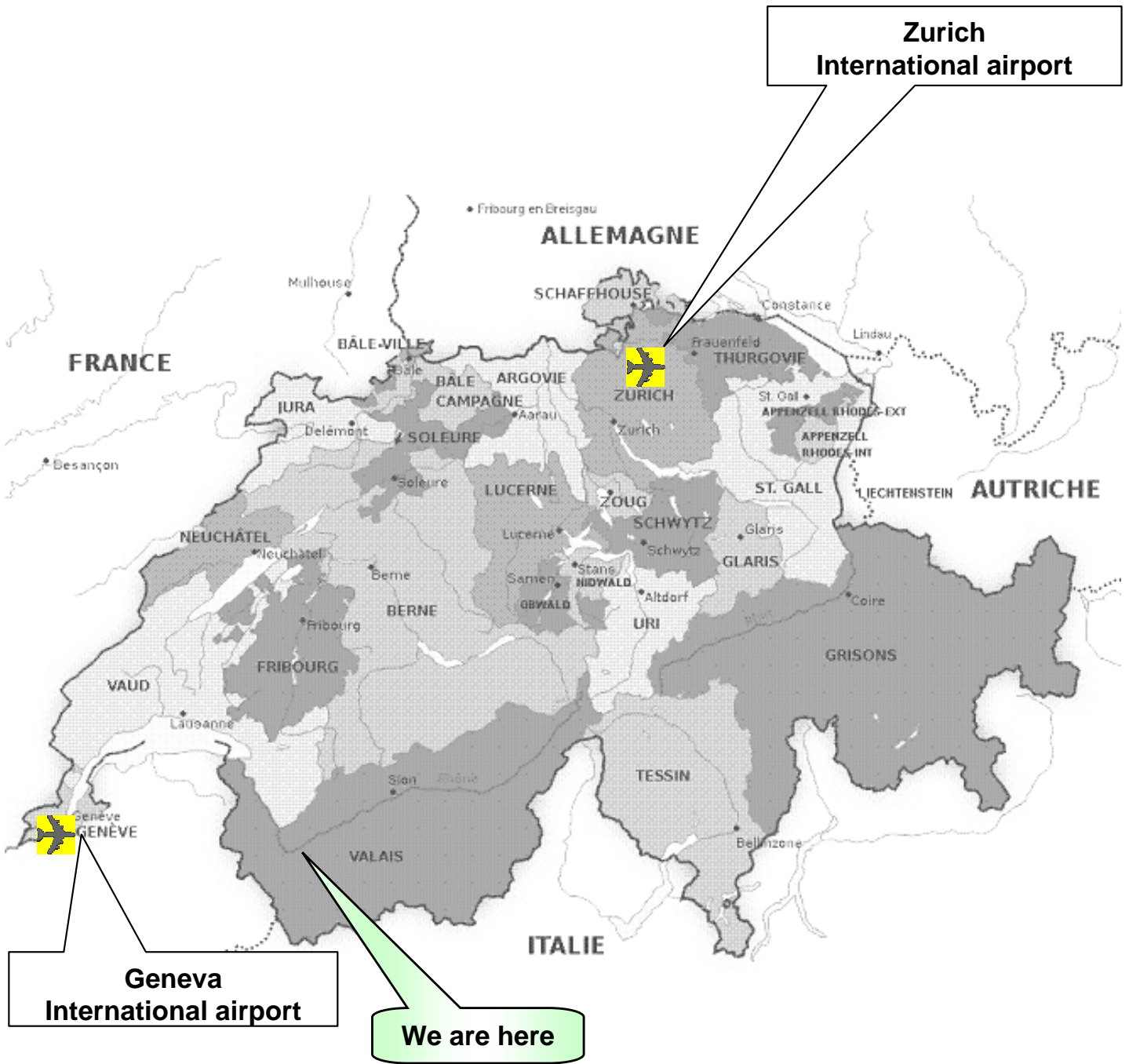

Geneva International airport to Isérables by car: 165Km / 1h45

Zurich International airport to Isérables by car : 287Km / 3h00



Contact:

DSMI Electronics S.A.

Customer Services

Rue du Téléphérique

CH-1914 Iséables

Phone: +41 (0)27 305 10 71

Fax: +41 (0)27 306 41 43

Internet: [www.dsmielectronics.com](http://www.dsmielectronics.com)

E-mail: [sales@dsmielectronics.com](mailto:sales@dsmielectronics.com)

### **Other products from DSMI Electronics SA:**

coax connectors, cable assembly and assembly subcontracting.

For further information, please contact our Customer Services.

Our authorized distributor:

Photography of the products by:  
©atelier clin d'oeil

**DSMI Electronics SA**  
Rue du Téléphérique  
CH-1914 Isérables

