

Darlington Complementary Silicon Power Transistors

... designed for general-purpose amplifier and low-frequency switching applications.

- High DC Current Gain @ $I_C = 10 \text{ A dc}$ –
 $h_{FE} = 2400 \text{ (Typ)} - 2N6284$
 $= 4000 \text{ (Typ)} - 2N6287$
- Collector–Emitter Sustaining Voltage –
 $V_{CEO(sus)} = 100 \text{ Vdc (Min)}$
- Monolithic Construction with Built–In Base–Emitter Shunt Resistors
- These devices are available in Pb–free package(s). Specifications herein apply to both standard and Pb–free devices. Please see our website at www.onsemi.com for specific Pb–free orderable part numbers, or contact your local ON Semiconductor sales office or representative.

***MAXIMUM RATINGS**

Rating	Symbol	2N6283 2N6286	2N6284 2N6287	Unit
Collector–Emitter Voltage	V_{CEO}	80	100	Vdc
Collector–Base Voltage	V_{CB}	80	100	Vdc
Emitter–Base Voltage	V_{EB}	5.0		Vdc
Collector Current – Continuous Peak	I_C	20 40		A dc
Base Current	I_B	0.5		A dc
Total Device Dissipation @ $T_C = 25^\circ\text{C}$ Derate above 25°C	P_D	160 0.915		Watts W/ $^\circ\text{C}$
Operating and Storage Junction Temperature Range	T_J, T_{stg}	–65 to +200		$^\circ\text{C}$

***THERMAL CHARACTERISTICS**

Characteristic	Symbol	Max	Unit
Thermal Resistance, Junction to Case	$R_{\theta JC}$	1.09	$^\circ\text{C/W}$

*Indicates JEDEC Registered Data.

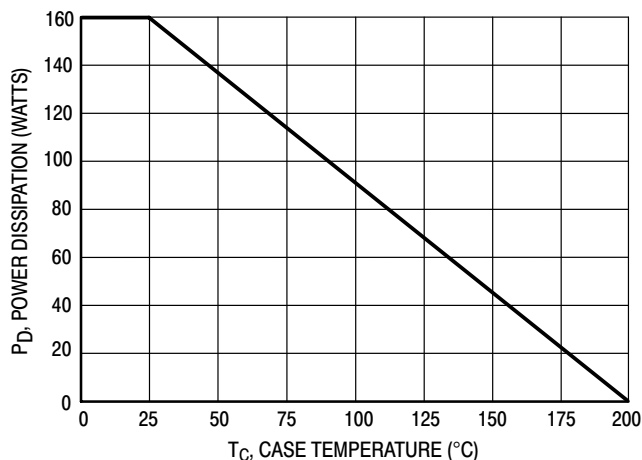

Figure 1. Power Derating

NPN
2N6283

2N6284
PNP
2N6286

2N6287

DARLINGTON
20 AMPERE
COMPLEMENTARY
SILICON
POWER TRANSISTORS
100 VOLTS
160 WATTS

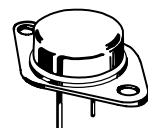

CASE 1–07
TO–204AA
(TO–3)

2N6283 2N6284 2N6286 2N6287

***ELECTRICAL CHARACTERISTICS** ($T_C = 25^\circ\text{C}$ unless otherwise noted)

Characteristic	Symbol	Min	Max	Unit
OFF CHARACTERISTICS				
Collector–Emitter Sustaining Voltage ($I_C = 0.1 \text{ Adc}$, $I_B = 0$)	$V_{CEO(sus)}$	80 100	– –	Vdc
Collector Cutoff Current ($V_{CE} = 40 \text{ Vdc}$, $I_B = 0$) ($V_{CE} = 50 \text{ Vdc}$, $I_B = 0$)	I_{CEO}	– –	1.0 1.0	mAdc
Collector Cutoff Current ($V_{CE} = \text{Rated } V_{CB}$, $V_{BE(off)} = 1.5 \text{ Vdc}$) ($V_{CE} = \text{Rated } V_{CB}$, $V_{BE(off)} = 1.5 \text{ Vdc}$, $T_C = 150^\circ\text{C}$)	I_{CEX}	– –	0.5 5.0	mAdc
Emitter Cutoff Current ($V_{BE} = 5.0 \text{ Vdc}$, $I_C = 0$)	I_{EBO}	–	2.0	mAdc
ON CHARACTERISTICS (1)				
DC Current Gain ($I_C = 10 \text{ Adc}$, $V_{CE} = 3.0 \text{ Vdc}$) ($I_C = 20 \text{ Adc}$, $V_{CE} = 3.0 \text{ Vdc}$)	h_{FE}	750 100	18,000 –	–
Collector–Emitter Saturation Voltage ($I_C = 10 \text{ Adc}$, $I_B = 40 \text{ mAdc}$) ($I_C = 20 \text{ Adc}$, $I_B = 200 \text{ mAdc}$)	$V_{CE(sat)}$	– –	2.0 3.0	Vdc
Base–Emitter On Voltage ($I_C = 10 \text{ Adc}$, $V_{CE} = 3.0 \text{ Vdc}$)	$V_{BE(on)}$	–	2.8	Vdc
Base–Emitter Saturation Voltage ($I_C = 20 \text{ Adc}$, $I_B = 200 \text{ mAdc}$)	$V_{BE(sat)}$	–	4.0	Vdc
DYNAMIC CHARACTERISTICS				
Magnitude of Common Emitter Small–Signal Short–Circuit Forward Current Transfer Ratio ($I_C = 10 \text{ Adc}$, $V_{CE} = 3.0 \text{ Vdc}$, $f = 1.0 \text{ MHz}$)	$ h_{fe} $	4.0	–	MHz
Output Capacitance ($V_{CB} = 10 \text{ Vdc}$, $I_E = 0$, $f = 0.1 \text{ MHz}$)	C_{ob}	– –	400 600	pF
Small–Signal Current Gain ($I_C = 10 \text{ Adc}$, $V_{CE} = 3.0 \text{ Vdc}$, $f = 1.0 \text{ kHz}$)	h_{fe}	300	–	–

*Indicates JEDEC Registered Data.

(1) Pulse test: Pulse Width = 300 μs , Duty Cycle = 2%

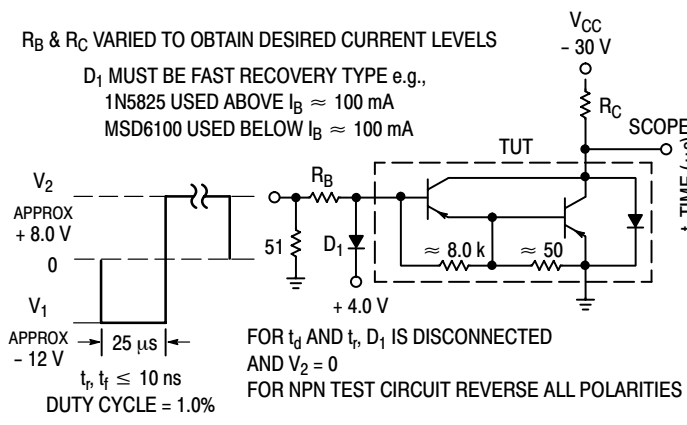

Figure 2. Switching Times Test Circuit

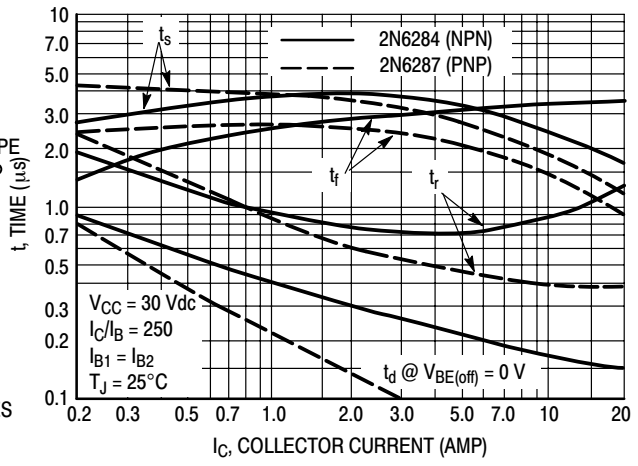

Figure 3. Switching Times

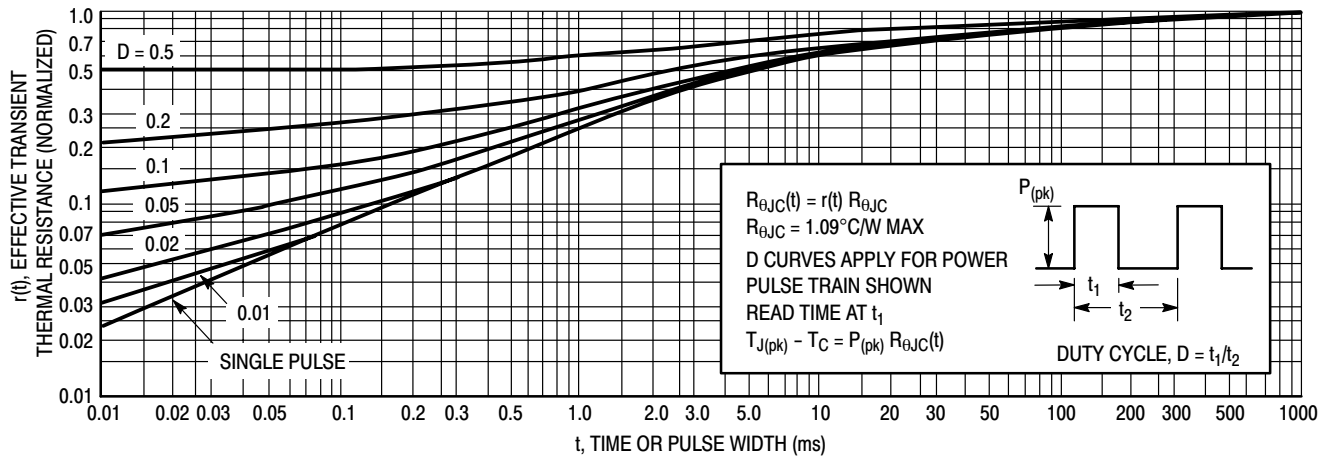

Figure 4. Thermal Response

ACTIVE-REGION SAFE OPERATING AREA

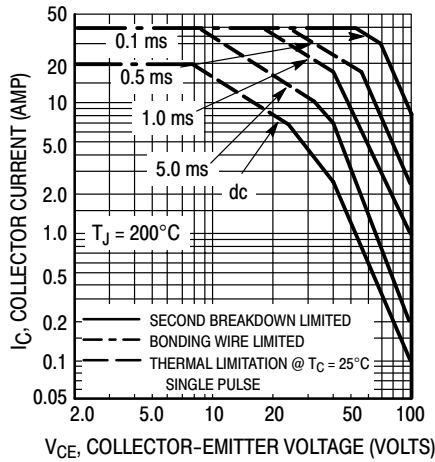

Figure 5. 2N6284, 2N6287

There are two limitations on the power handling ability of a transistor: average junction temperature and second breakdown. Safe operating area curves indicate $I_C - V_{CE}$ limits of the transistor that must be observed for reliable operation; i.e. the transistor must not be subjected to greater dissipation than the curves indicate.

The data of Figure 5 is based on $T_{J(pk)} = 200^\circ\text{C}$; T_C is variable depending on conditions. Second breakdown pulse limits are valid for duty cycles to 10% provided $T_{J(pk)} < 200^\circ\text{C}$. $T_{J(pk)}$ may be calculated from the data in Figure 4. At high case temperatures, thermal limitations will reduce the power that can be handled to values less than the limitations imposed by second breakdown.

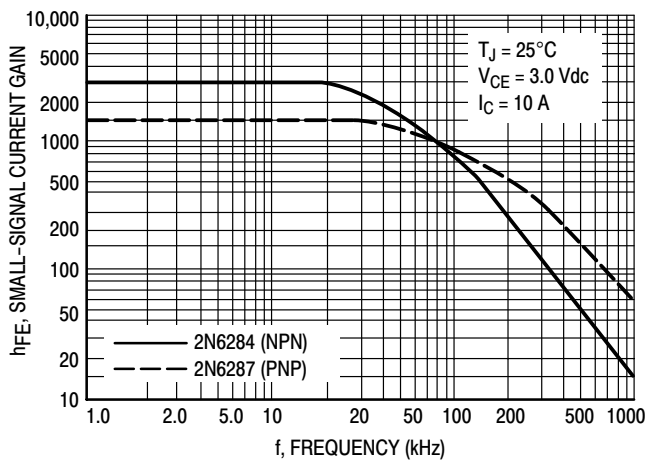

Figure 6. Small-Signal Current Gain

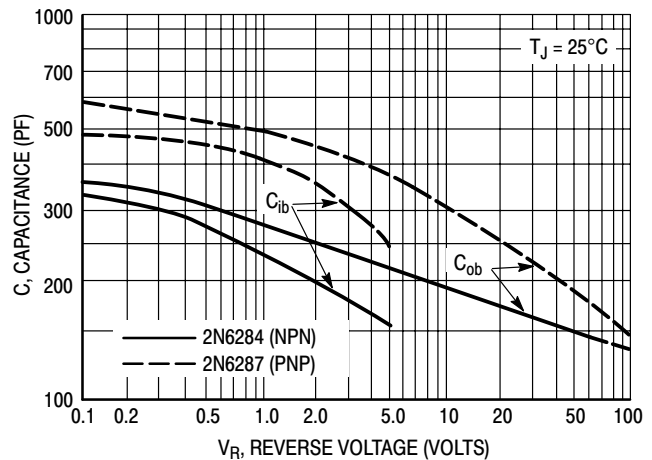
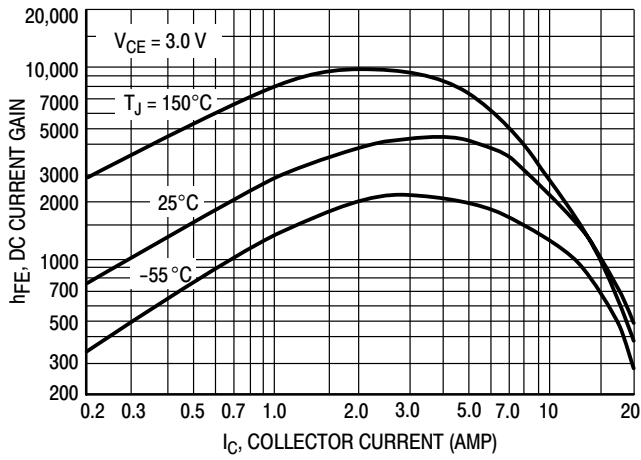

Figure 7. Capacitance

**NPN
2N6284**



**PNP
2N6287**

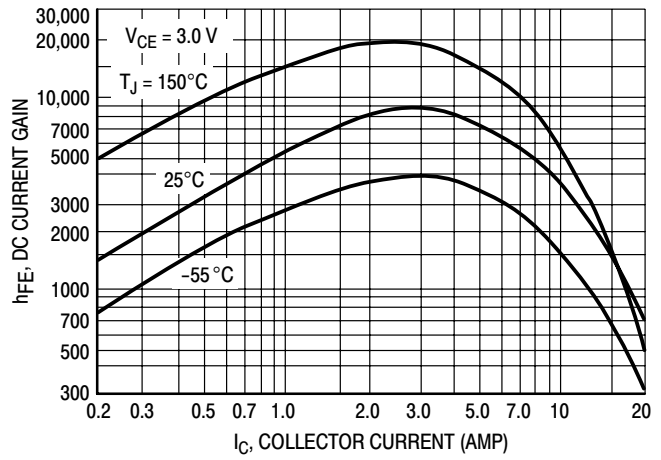

Figure 8. DC Current Gain

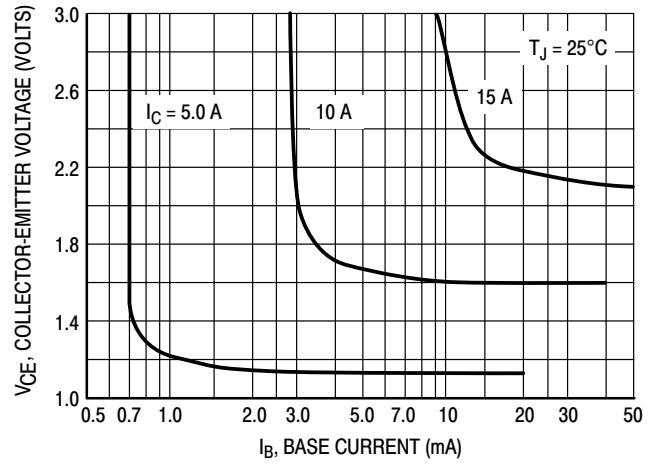
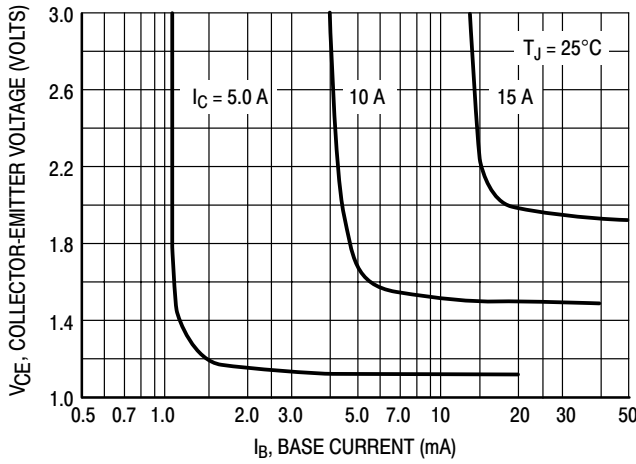

Figure 9. Collector Saturation Region

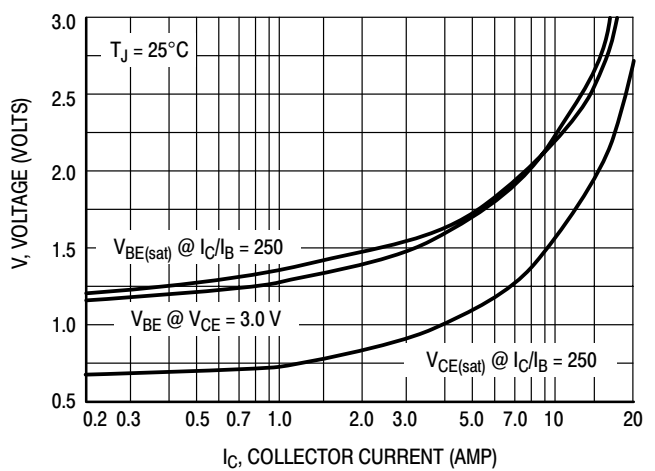
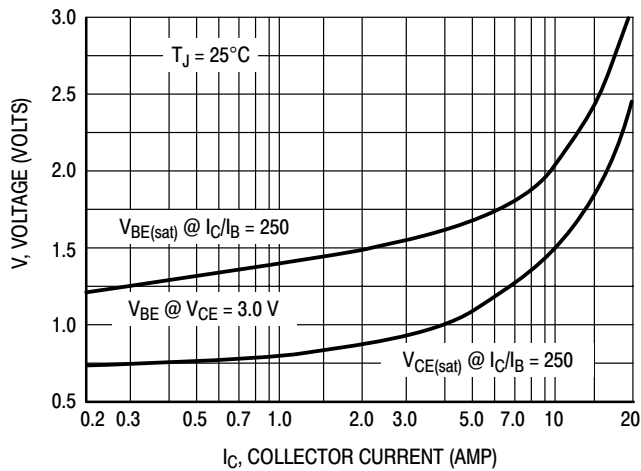

Figure 10. "On" Voltages

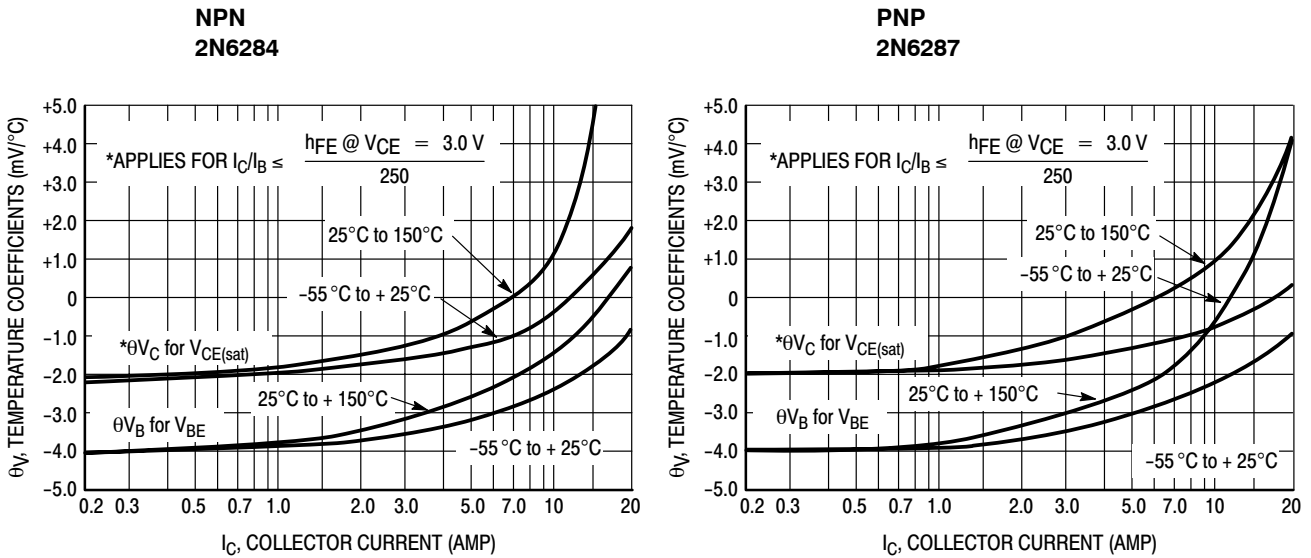

Figure 11. Temperature Coefficients

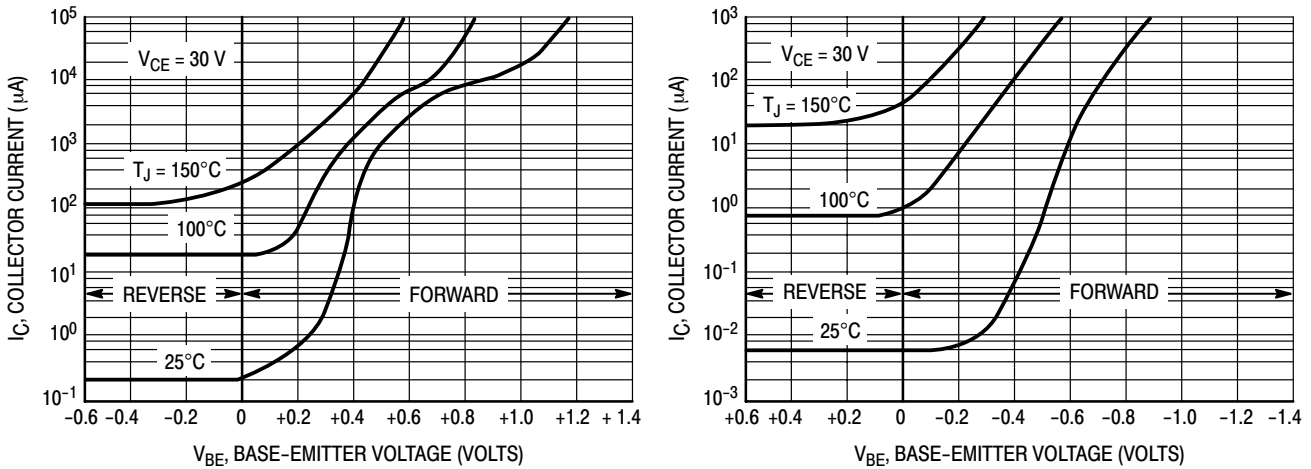

Figure 12. Collector Cut-Off Region

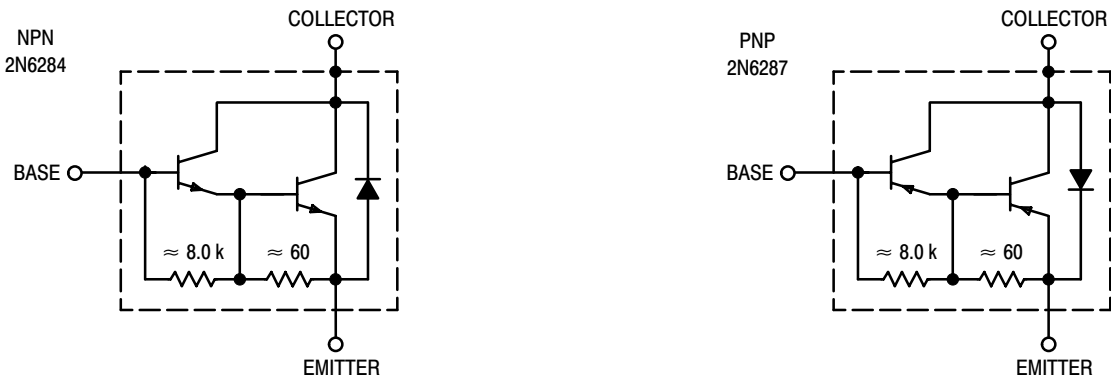
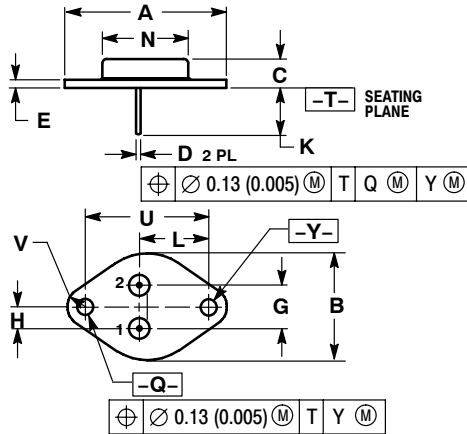

Figure 13. Darlington Schematic

2N6283 2N6284 2N6286 2N6287

PACKAGE DIMENSIONS

CASE 1-07 TO-204AA (TO-3) ISSUE Z



NOTES:

1. DIMENSIONING AND TOLERANCING PER ANSI Y14.5M, 1982.
2. CONTROLLING DIMENSION: INCH.
3. ALL RULES AND NOTES ASSOCIATED WITH REFERENCED TO-204AA OUTLINE SHALL APPLY.

DIM	INCHES		MILLIMETERS	
	MIN	MAX	MIN	MAX
A	---	1.550 REF	---	39.37 REF
B	---	1.050	---	26.67
C	0.250	0.335	6.35	8.51
D	0.038	0.043	0.97	1.09
E	0.055	0.070	1.40	1.77
G	0.430 BSC		10.92 BSC	
H	0.215 BSC		5.46 BSC	
K	0.440	0.480	11.18	12.19
L	0.665 BSC		16.89 BSC	
N	---	0.830	---	21.08
Q	0.151	0.165	3.84	4.19
U	1.187 BSC		30.15 BSC	
V	0.131	0.188	3.33	4.77

STYLE 1:

1. BASE
 2. EMITTER
- CASE: COLLECTOR

ON Semiconductor and are registered trademarks of Semiconductor Components Industries, LLC (SCILLC). SCILLC reserves the right to make changes without further notice to any products herein. SCILLC makes no warranty, representation or guarantee regarding the suitability of its products for any particular purpose, nor does SCILLC assume any liability arising out of the application or use of any product or circuit, and specifically disclaims any and all liability, including without limitation special, consequential or incidental damages. "Typical" parameters which may be provided in SCILLC data sheets and/or specifications can and do vary in different applications and actual performance may vary over time. All operating parameters, including "Typicals" must be validated for each customer application by customer's technical experts. SCILLC does not convey any license under its patent rights nor the rights of others. SCILLC products are not designed, intended, or authorized for use as components in systems intended for surgical implant into the body, or other applications intended to support or sustain life, or for any other application in which the failure of the SCILLC product could create a situation where personal injury or death may occur. Should Buyer purchase or use SCILLC products for any such unintended or unauthorized application, Buyer shall indemnify and hold SCILLC and its officers, employees, subsidiaries, affiliates, and distributors harmless against all claims, costs, damages, and expenses, and reasonable attorney fees arising out of, directly or indirectly, any claim of personal injury or death associated with such unintended or unauthorized use, even if such claim alleges that SCILLC was negligent regarding the design or manufacture of the part. SCILLC is an Equal Opportunity/Affirmative Action Employer. This literature is subject to all applicable copyright laws and is not for resale in any manner.

PUBLICATION ORDERING INFORMATION

LITERATURE FULFILLMENT:

Literature Distribution Center for ON Semiconductor
P.O. Box 61312, Phoenix, Arizona 85082-1312 USA
Phone: 480-829-7710 or 800-344-3860 Toll Free USA/Canada
Fax: 480-829-7709 or 800-344-3867 Toll Free USA/Canada
Email: orderlit@onsemi.com

N. American Technical Support: 800-282-9855 Toll Free
USA/Canada

Japan: ON Semiconductor, Japan Customer Focus Center
2-9-1 Kamimeguro, Meguro-ku, Tokyo, Japan 153-0051
Phone: 81-3-5773-3850

ON Semiconductor Website: <http://onsemi.com>

Order Literature: <http://www.onsemi.com/litorder>

For additional information, please contact your local Sales Representative.