

SMD/BLOCK Type EMI Suppression Filters

EMIFIL[®]



*Innovator
in Electronics*

**Murata
Manufacturing Co., Ltd.**

△Note • Please read rating and △CAUTION (for storage, operating, rating, soldering, mounting and handling) in this catalog to prevent smoking and/or burning, etc.
• This catalog has only typical specifications because there is no space for detailed specifications. Therefore, please review our product specifications or consult the approval sheet for product specifications before ordering.

C31E.pdf
Mar.28,2011



Chip Common Mode Choke Coil
Large Current Common Mode Choke Coil for Automotive Available

Series Introduction	150
Part Numbering	152
Series Line Up	154
Product Detail	156
⚠Caution/Notice	174
Soldering and Mounting	176
Packaging	182
Design Kits	184

⚠Note • Please read rating and ⚠CAUTION (for storage, operating, rating, soldering, mounting and handling) in this catalog to prevent smoking and/or burning, etc.
• This catalog has only typical specifications because there is no space for detailed specifications. Therefore, please review our product specifications or consult the approval sheet for product specifications before ordering.

DL Series Introduction

Common Mode Current

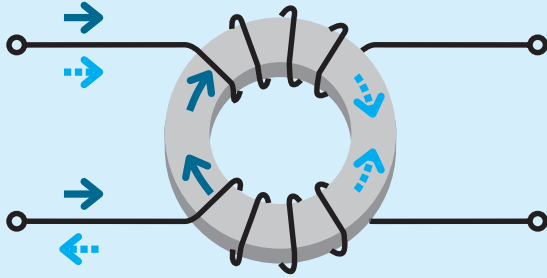

Differential Mode Current

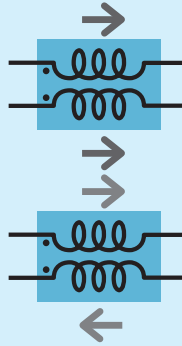

Magnetic flux by common mode current is added each other and works as an inductor

Magnetic flux by differential mode current is canceled each other and do not works as an inductor

Category	Features, Classification	Structure	Part Number	Comments
High cut-off frequency High Coupling (For high speed differential signal lines)	Ultra high cut-off frequency for high speed differential signal lines	Film type	DLP11SA	<ul style="list-style-type: none"> Low profile, small size, suitable for mobile equipments. Tight terminal pitch enables high density layout. Ultra high cut-off frequency and its matching to line impedance enables good transmission of high speed signal.
		Wound type	DLW21SN_HQ2	<ul style="list-style-type: none"> Ultra high self resonance frequency enables high cut-off frequency. Its matching to line impedance enables good transmission of high speed signal.
	High cut-off frequency for high speed differential signal lines	Film type	DLP0NS DLP11SN DLP2AD	<ul style="list-style-type: none"> Low profile, small size, suitable for mobile equipments. Tight terminal pitch enables high density layout. High cut-off frequency enables good transmission of high speed signal.
		Wound type	DLW21SN_SQ2 DLW31S DLW21H	<ul style="list-style-type: none"> Ultra high self resonance frequency enables high cut-off frequency. DLW21H is designed as low profile.
	for general differential signal lines	Film type	DLP31S DLP31D	<ul style="list-style-type: none"> Low profile, small size, suitable for mobile equipments. Tight terminal pitch enables high density layout.
Large current High coupling (For power lines)		Wound type	DLW5AH DLW5BS DLW5BT	<ul style="list-style-type: none"> Large current (6A max.), suitable for input connector from an AC adaptor. DLW5BT is designed as low profile.
Relative high differential mode impedance Low coupling (For audio lines)		Multilayer type	DLM11G DLM2HG	<ul style="list-style-type: none"> Modified its differential mode impedance higher than other common mode choke coils, this feature makes possible to suppress both common mode and differential mode noise. DLM11GN601SD2 is ideal to keep low distortion audio signal. DLM2HG can meet stereo 3 lines which contain a ground line.
Large current Automotive Available (For power lines)	Available up to 10A	Winding type Cased structure	PLT10HH	<ul style="list-style-type: none"> Large current, high reliability, suitable for mortors in automobile.

△Note • Please read rating and △CAUTION (for storage, operating, rating, soldering, mounting and handling) in this catalog to prevent smoking and/or burning, etc.
 • This catalog has only typical specifications because there is no space for detailed specifications. Therefore, please review our product specifications or consult the approval sheet for product specifications before ordering.

Skew Improve Effect of Common Mode Choke Coil

Example of Skew Improvement by Common Mode Choke Coil (Test using pulse generator waveform)

Waveform is equivalent to 1000Mbps signal

Waveform with intentionally made skew (skew: 100ps)

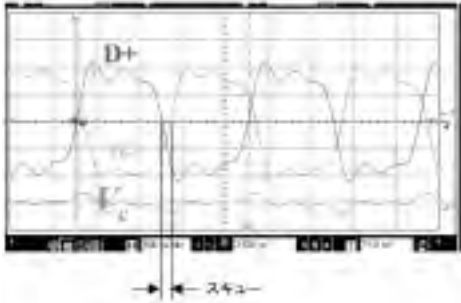

Skew is improved by common mode choke coil

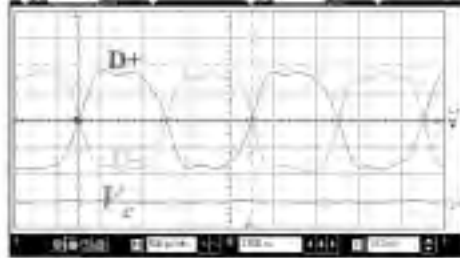

Mechanism of Skew Improvement

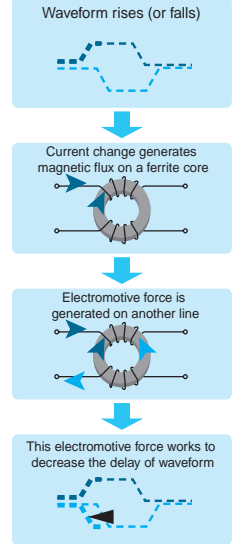

Noise Suppression of Common Mode Choke Coil in HDMI Line

Device under test / Transmitter : game machine Receiver : projector

Cable / HDMI category2 3m cable

Test resolution / 1080p Deep color 12bit (Data 1.11GHz) DVD play mode

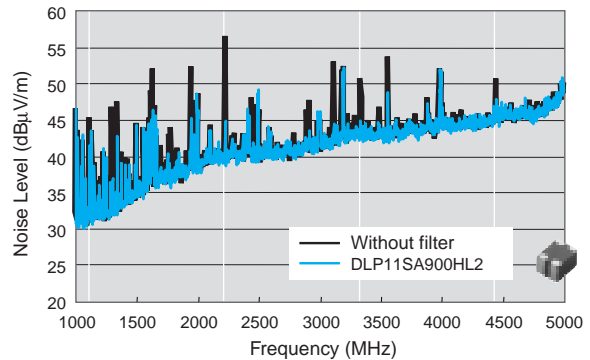
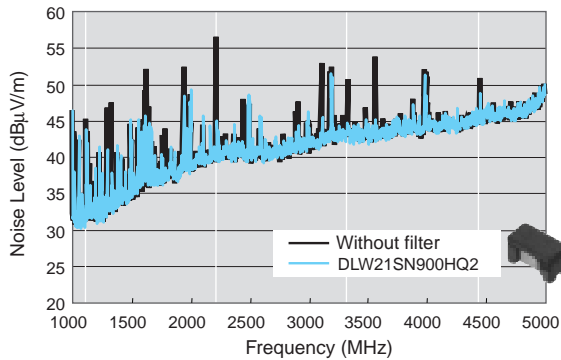

Test Example of HDMI1.3 Waveform Transmission

~Using ESD protection device 0.05pF~

Signal frequency : 1.11GHz (Deep color 12bit)

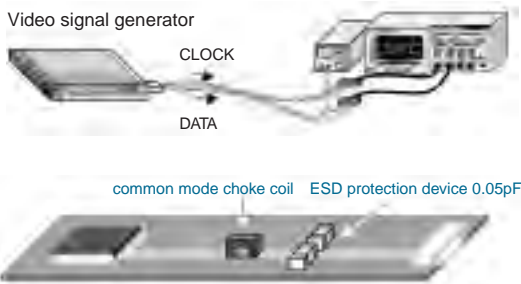

ESD protection device only



Film Type DLP11SN900HL2 (Cut-off frequency is most low in the table below)



	Wound Type DLW21SN900HQ2	Film Type DLP11SA900HL2	Film Type Array DLP2ADN900HL4
Cut-off Frequency	Over 10GHz	Around 6GHz	Around 4GHz
Judge	Specification satisfied	Specification satisfied	Specification satisfied
Transition Time	Rise time: 83.4ps Fall time: 77.4ps	Rise time: 90.4ps Fall time: 85.5ps	Rise time: 100ps Fall time: 97.4ps

Each of common mode choke coil can keep waveform, satisfy the specification.

△Note • Please read rating and △CAUTION (for storage, operating, rating, soldering, mounting and handling) in this catalog to prevent smoking and/or burning, etc.
• This catalog has only typical specifications because there is no space for detailed specifications. Therefore, please review our product specifications or consult the approval sheet for product specifications before ordering.

DL □ Chip Common Mode Choke Coil Part Numbering

(Part Number) DL W 21 S N 371 S Q 2 L

① ② ③ ④ ⑤ ⑥ ⑦ ⑧ ⑨ ⑩

① Product ID

Product ID	
DL	Chip Common Mode Choke Coils

② Structure

Code	Structure
W	Wire Wound Type
M	Multilayer Type
P	Film Type

③ Dimensions (L×W)

Code	Dimensions (L×W)	EIA
0N	0.85×0.65mm	03025
11	1.25×1.0mm	0504
1N	1.5×0.65mm	05025
21	2.0×1.2mm	0805
31	3.2×1.6mm	1206
2A	2.0×1.0mm	0804
2H	2.5×2.0mm	1008
5A	5.0×3.6mm	2014
5B	5.0×5.0mm	2020

④ Features (1)

Code	Type
S	Magnetically Shielded One Circuit Type
D	Magnetically Shielded Two Circuit Type
H	Open Magnetic One Circuit Type
G	Magnetically Monolithic Type (sectional winding)
T	Magnetically Shielded One Circuit Low Profile Type

⑩ Packaging

Code	Packaging	Series
K	Embossed Taping (ø330mm Reel)	DLW5AH/DLW5BS/DLW5BT
L	Embossed Taping (ø180mm Reel)	All Series
B	Bulk	All Series

⑤ Category

Code	Category
A	Expressed by a letter.
B	
C	
N	
R	

⑥ Impedance

Typical impedance at 100MHz is expressed by three figures. The unit is in ohm (Ω). The first and second figures are significant digits, and the third figure expresses the number of zeros which follow the two figures.

⑦ Circuit

Code	Circuit
S	Expressed by a letter.
M	
H	
U	

⑧ Features (2)

Code	Features
D	Expressed by a letter.
L	
Q	
Z	

⑨ Number of Signal Lines

Code	Number of Signal Lines
2	Two Lines
3	Three Lines
4	Four Lines

△Note • Please read rating and △CAUTION (for storage, operating, rating, soldering, mounting and handling) in this catalog to prevent smoking and/or burning, etc.
• This catalog has only typical specifications because there is no space for detailed specifications. Therefore, please review our product specifications or consult the approval sheet for product specifications before ordering.

PL □ Common Mode Choke Coils Part Numbering

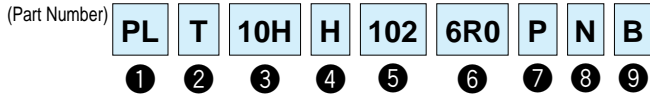

① Product ID

Product ID	
PL	Common Mode Choke Coils

② Type

Code	Type
T	DC Type

③ Applications

Code	Applications
10H	for DC Line High-frequency Type

④ Features

Code	Features
H	for Automotive

⑨ Packaging

Code	Packaging	Series
B	Bulk	PLT10H
L	Embossed Taping (ø178mm/ø180mm Reel)	PLT10H
K	Embossed Taping (ø330mm Reel)	PLT10H

⑤ Impedance

Expressed by three figures. The unit is ohm (Ω). The first and second figures are significant digits, and the third figure expresses the number of zeros which follow the two figures.

⑥ Rated Current

Expressed by three figures. The unit is ampere (A). The first and second figures are significant digits, and the third figure expresses the number of zeros which follow the two figures. A decimal point is expressed by the capital letter "R". In this case, all figures are significant digits.

⑦ Winding Mode

Code	Winding Mode
P	Aligned Winding Type

⑧ Lead Dimensions

Code	Lead Dimensions
N	No Lead Terminal (SMD)

Note • Please read rating and **CAUTION** (for storage, operating, rating, soldering, mounting and handling) in this catalog to prevent smoking and/or burning, etc.
 • This catalog has only typical specifications because there is no space for detailed specifications. Therefore, please review our product specifications or consult the approval sheet for product specifications before ordering.

Type	Size Code (Inch)	Thickness (mm)	Part Number	Common Mode Impedance (at 100MHz/20°C)	Rated Current	Features						
						New	K _{fit}	≥1A ≥3A	H _D U _D	Z _{match}	Flow	R _{eFlow}
Multilayer Type for Audio Lines	0504 <i>p158</i>	0.5	DLM11GN601SD2	600ohm±25%	100mA							R _{eFlow}
	1008 <i>p159</i>	1.2	DLM2HGN601SZ3	600ohm±25%	100mA						Flow	R _{eFlow}
Film Type for Differential Signal Lines	<i>p160</i>	0.45	DLP0NSN670HL2	67ohm±20%	110mA		K _{fit}	H _D	Z _{match}			R _{eFlow}
		0.45	DLP0NSN900HL2	90ohm±20%	100mA		K _{fit}	H _D	Z _{match}			R _{eFlow}
		0.45	DLP0NSN121HL2	120ohm±20%	90mA		K _{fit}	H _D	Z _{match}			R _{eFlow}
		0.45	DLP0NSA150HL2	15ohm±5ohm	100mA	New	K _{fit}	U _D	Z _{match}			R _{eFlow}
		0.45	DLP0NSC280HL2	28ohm±20%	100mA		K _{fit}	U _D	Z _{match}			R _{eFlow}
	<i>p162</i>	0.82	DLP11SN670SL2	67ohm±20%	180mA		K _{fit}	H _D				R _{eFlow}
		0.82	DLP11SN121SL2	120ohm±20%	140mA		K _{fit}	H _D				R _{eFlow}
		0.82	DLP11SN161SL2	160ohm±20%	120mA		K _{fit}	H _D				R _{eFlow}
		0.82	DLP11SN900HL2	90ohm±20%	150mA		K _{fit}	H _D	Z _{match}			R _{eFlow}
		0.82	DLP11SN201HL2	200ohm±20%	110mA		K _{fit}	H _D	Z _{match}			R _{eFlow}
		0.82	DLP11SN241HL2	240ohm±20%	100mA		K _{fit}	H _D	Z _{match}			R _{eFlow}
		0.82	DLP11SN281HL2	280ohm±20%	90mA		K _{fit}	H _D	Z _{match}			R _{eFlow}
		0.82	DLP11SN331HL2	330ohm±20%	80mA		K _{fit}	H _D	Z _{match}			R _{eFlow}
		0.82	DLP11SA350HL2	35ohm±20%	170mA		K _{fit}	U _D	Z _{match}			R _{eFlow}
		0.82	DLP11SA670HL2	67ohm±20%	150mA		K _{fit}	U _D	Z _{match}			R _{eFlow}
	<i>p163</i>	0.3	DLP11TB800UL2	80ohm±25%	100mA	New	K _{fit}	U _D	Z _{match}			R _{eFlow}
	<i>p164</i>	1.15	DLP31SN121ML2	120ohm±20%	100mA			H _D				R _{eFlow}
		1.15	DLP31SN221ML2	220ohm±20%	100mA			H _D				R _{eFlow}
		1.15	DLP31SN551ML2	550ohm±20%	100mA			H _D				R _{eFlow}
	Film Array Type for Differential Signal Lines	<i>p165</i>	0.45	DLP1NDN350HL4	35ohm±20%	100mA	New	K _{fit}	U _D	Z _{match}		
0.45			DLP1NDN670HL4	67ohm±20%	80mA	New	K _{fit}	U _D	Z _{match}			R _{eFlow}
0.45			DLP1NDN900HL4	90ohm±20%	60mA	New	K _{fit}	U _D	Z _{match}			R _{eFlow}
<i>p166</i>		0.82	DLP2ADA350HL4	35ohm±20%	150mA		K _{fit}	U _D	Z _{match}			R _{eFlow}
		0.82	DLP2ADA670HL4	67ohm±20%	130mA		K _{fit}	U _D	Z _{match}			R _{eFlow}
		0.82	DLP2ADA900HL4	90ohm±20%	120mA		K _{fit}	U _D	Z _{match}			R _{eFlow}
		0.82	DLP2ADN670HL4	67ohm±20%	140mA		K _{fit}	H _D	Z _{match}			R _{eFlow}
		0.82	DLP2ADN900HL4	90ohm±20%	130mA		K _{fit}	H _D	Z _{match}			R _{eFlow}
		0.82	DLP2ADN121HL4	120ohm±20%	120mA		K _{fit}	H _D	Z _{match}			R _{eFlow}
		0.82	DLP2ADN161HL4	160ohm±20%	100mA		K _{fit}	H _D	Z _{match}			R _{eFlow}
		0.82	DLP2ADN201HL4	200ohm±20%	90mA		K _{fit}	H _D	Z _{match}			R _{eFlow}
<i>p168</i>		0.82	DLP2ADN241HL4	240ohm±20%	80mA		K _{fit}	H _D	Z _{match}			R _{eFlow}
		0.82	DLP2ADN281HL4	280ohm±20%	80mA		K _{fit}	H _D	Z _{match}			R _{eFlow}
		1.15	DLP31DN900ML4	90ohm±20%	160mA			H _D				R _{eFlow}
		1.15	DLP31DN131ML4	130ohm±20%	120mA			H _D				R _{eFlow}
	1.15	DLP31DN201ML4	200ohm±20%	100mA			H _D				R _{eFlow}	
	1.15	DLP31DN321ML4	320ohm±20%	80mA			H _D				R _{eFlow}	
	1.15	DLP31DN441ML4	440ohm±20%	70mA			H _D				R _{eFlow}	
Wire Wound Type for Differential Signal Lines	<i>p169</i>	1.2	DLW21SN670SQ2	67ohm±25%	400mA		K _{fit}	H _D				R _{eFlow}
		1.2	DLW21SN900SQ2	90ohm±25%	330mA		K _{fit}	H _D				R _{eFlow}
		1.2	DLW21SN121SQ2	120ohm±25%	370mA		K _{fit}	H _D				R _{eFlow}
		1.2	DLW21SN181SQ2	180ohm±25%	330mA		K _{fit}	H _D				R _{eFlow}
		1.2	DLW21SN261SQ2	260ohm±25%	300mA		K _{fit}	H _D				R _{eFlow}
		1.2	DLW21SN371SQ2	370ohm±25%	280mA		K _{fit}	H _D				R _{eFlow}
		1.2	DLW21SN670HQ2	67ohm±25%	320mA		K _{fit}	U _D	Z _{match}			R _{eFlow}
		1.2	DLW21SN900HQ2	90ohm±25%	280mA		K _{fit}	U _D	Z _{match}			R _{eFlow}
		1.2	DLW21SN121HQ2	120ohm±25%	280mA		K _{fit}	U _D	Z _{match}			R _{eFlow}
	<i>p171</i>	0.9	DLW21SR670HQ2	67ohm±25%	400mA		K _{fit}	U _D	Z _{match}			R _{eFlow}
		0.9	DLW21HN670SQ2	67ohm±25%	330mA		K _{fit}	H _D				R _{eFlow}
		0.9	DLW21HN900SQ2	90ohm±25%	330mA		K _{fit}	H _D				R _{eFlow}
		0.9	DLW21HN121SQ2	120ohm±25%	280mA		K _{fit}	H _D				R _{eFlow}
		0.9	DLW21HN181SQ2	180ohm±25%	250mA		K _{fit}	H _D				R _{eFlow}
	<i>p172</i>	1.9	DLW31SN900SQ2	90ohm±25%	370mA			H _D				R _{eFlow}
		1.9	DLW31SN161SQ2	160ohm±25%	340mA			H _D				R _{eFlow}
		1.9	DLW31SN261SQ2	260ohm±25%	310mA			H _D				R _{eFlow}
		1.9	DLW31SN601SQ2	600ohm±25%	260mA			H _D				R _{eFlow}
1.9		DLW31SN102SQ2	1000ohm±25%	230mA			H _D				R _{eFlow}	
1206	1.9	DLW31SN222SQ2	2200ohm±25%	200mA			H _D				R _{eFlow}	

Continued on the following page.

△Note • Please read rating and △CAUTION (for storage, operating, rating, soldering, mounting and handling) in this catalog to prevent smoking and/or burning, etc.
• This catalog has only typical specifications because there is no space for detailed specifications. Therefore, please review our product specifications or consult the approval sheet for product specifications before ordering.

DL□ Chip Common Mode Choke Coil Series Line Up

Type	Size Code (Inch)	Thickness (mm)	Part Number	Common Mode Impedance (at 100MHz/20°C)	Rated Current	New	Kit	≥1A	Hd	≥3A	Ud	Z _{match}	F _{low}	R _{eFlow}	
Wire Wound Type for Power Lines and Signal Lines	2014 ^{p156}	4.3	DLW5AHN402SQ2	4000ohm(Typ.)	200mA		Kit							R _{eFlow}	
	2020 ^{p156}	4.5	DLW5BSN191SQ2	190ohm(Typ.)	5000mA		Kit	≥3A							R _{eFlow}
		4.5	DLW5BSN351SQ2	350ohm(Typ.)	2000mA		Kit	≥1A							R _{eFlow}
		4.5	DLW5BSN102SQ2	1000ohm(Typ.)	1500mA		Kit	≥1A							R _{eFlow}
		4.5	DLW5BSN152SQ2	1500ohm(Typ.)	1000mA		Kit	≥1A							R _{eFlow}
	2020 ^{p157}	4.5	DLW5BSN302SQ2	3000ohm(Typ.)	500mA		Kit								R _{eFlow}
		2.5	DLW5BTN101SQ2	100ohm(Typ.)	6000mA		Kit	≥3A							R _{eFlow}
		2.5	DLW5BTN251SQ2	250ohm(Typ.)	5000mA		Kit	≥3A							R _{eFlow}
		2.5	DLW5BTN501SQ2	500ohm(Typ.)	4000mA		Kit	≥3A							R _{eFlow}
		2.5	DLW5BTN102SQ2	1000ohm(Typ.)	2000mA		Kit	≥1A							R _{eFlow}
2.5		DLW5BTN142SQ2	1400ohm(Typ.)	1500mA		Kit	≥1A							R _{eFlow}	

PL□ Large Current Common Mode Choke Coil for Automotive Available Series Line Up

Type	Size	Thickness (mm)	Part Number	Common Mode Impedance (at 10MHz/20°C)	Rated Current	New	Kit	≥3A	Hd	≥10A	Ud	Z _{match}	F _{low}	R _{eFlow}
Large Current Common Mode Choke Coil for Automotive Available	12.9x6.6 (mm)	9.4	PLT10HH401100PN	400ohm	10A	New	Kit	≥10A						R _{eFlow}
		9.4	PLT10HH501100PN	500ohm	10A	New	Kit	≥10A						R _{eFlow}
		9.4	PLT10HH9016R0PN	900ohm	6A	New	Kit	≥3A						R _{eFlow}
		9.4	PLT10HH1026R0PN	1000ohm	6A	New	Kit	≥3A						R _{eFlow}

△Note • Please read rating and △CAUTION (for storage, operating, rating, soldering, mounting and handling) in this catalog to prevent smoking and/or burning, etc.
 • This catalog has only typical specifications because there is no space for detailed specifications. Therefore, please review our product specifications or consult the approval sheet for product specifications before ordering.

DLW5AH/DLW5BS Series (2014/2020 Size)



5A max, common mode choke coil for power lines.

Chip Ferrite Bead

Chip EMIFIL®

Chip Common Mode Choke Coil
Universal Type [Power Lines/Signal Lines]

Block Type EMIFIL®

DLW5AH



■ Dimensions

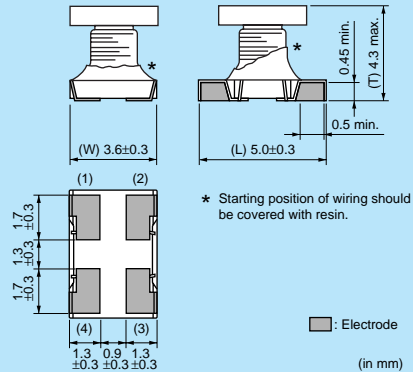

* Starting position of wiring should be covered with resin.

Legend: Electrode

(in mm)

■ Equivalent Circuit

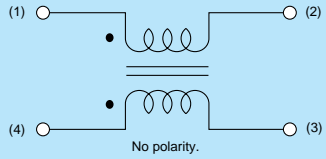

No polarity.

■ Packaging

Code	Packaging	Minimum Quantity
L	180mm Reel Embossed Tape	400
K	330mm Reel Embossed Tape	1500
B	Bulk(Bag)	100

DLW5BS



■ Dimensions

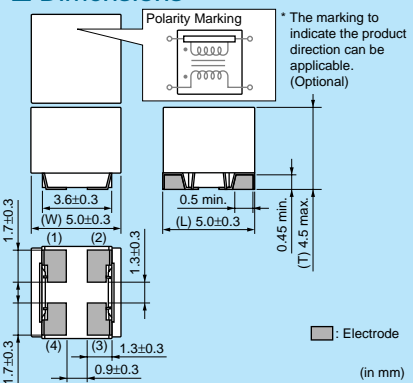

* The marking to indicate the product direction can be applicable. (Optional)

Legend: Electrode

(in mm)

■ Equivalent Circuit

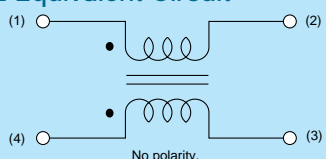

No polarity.

■ Packaging

Code	Packaging	Minimum Quantity
L	180mm Reel Embossed Tape	400
K	330mm Reel Embossed Tape	1500
B	Bulk(Bag)	100

Refer to pages from p.176 to p.179 for mounting information.

■ Rated Value (□: packaging code)

Part Number	Common Mode Impedance (at 100MHz/20°C)	Rated Current	Rated Voltage	Insulation Resistance (min.)	Withstand Voltage	DC Resistance	
DLW5AHN402SQ□	4000ohm(Typ.)	200mA	50Vdc	10M ohm	125Vdc	3.0ohm max.	Kit
DLW5BSN191SQ□	190ohm(Typ.)	500mA	50Vdc	10M ohm	125Vdc	0.02ohm max.	Kit ≥3A
DLW5BSN351SQ□	350ohm(Typ.)	2000mA	50Vdc	10M ohm	125Vdc	0.04ohm max.	Kit ≥1A
DLW5BSN102SQ□	1000ohm(Typ.)	1500mA	50Vdc	10M ohm	125Vdc	0.06ohm max.	Kit ≥1A
DLW5BSN152SQ□	1500ohm(Typ.)	1000mA	50Vdc	10M ohm	125Vdc	0.1 ohm max.	Kit ≥1A
DLW5BSN302SQ□	3000ohm(Typ.)	500mA	50Vdc	10M ohm	125Vdc	0.3ohm max.	Kit

Operating Temperature Range: -25°C to +85°C (DLW5AH), -40°C to +85°C (DLW5BS) Number of Circuit: 1

■ Impedance-Frequency Characteristics (Main Items)

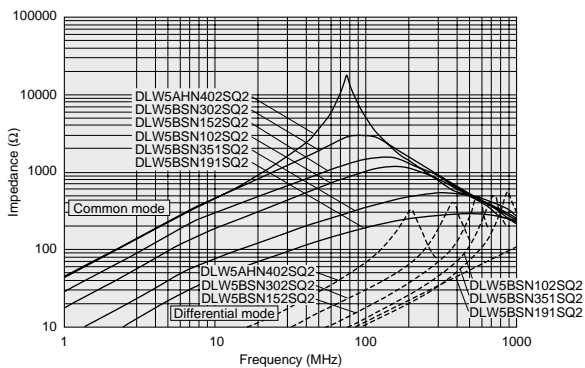

■ Derating of Rated Current

DLW5BSN191

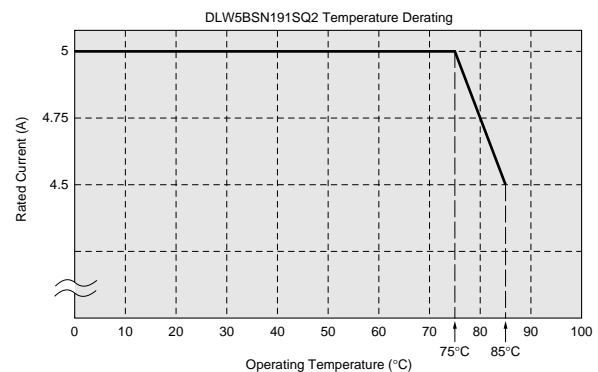

△Note • Please read rating and △CAUTION (for storage, operating, rating, soldering, mounting and handling) in this catalog to prevent smoking and/or burning, etc.
• This catalog has only typical specifications because there is no space for detailed specifications. Therefore, please review our product specifications or consult the approval sheet for product specifications before ordering.

DLW5BT Series (2020 Size)



Low profile wire-wound common choke coil for power lines.



■ Dimensions

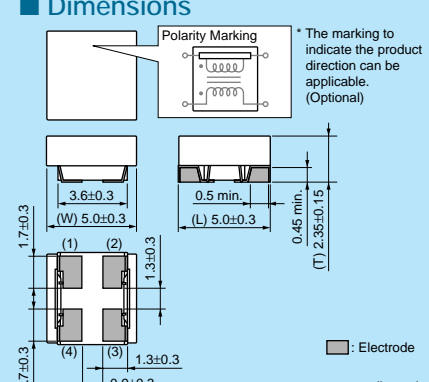

■ Polarity Marking: The marking to indicate the product direction can be applicable. (Optional)

■ Electrode (in mm)

■ Equivalent Circuit

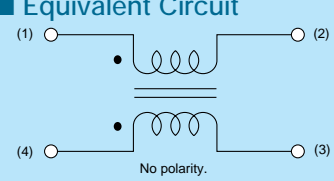

■ Packaging

Code	Packaging	Minimum Quantity
L	180mm Reel Embossed Tape	700
K	330mm Reel Embossed Tape	2500
B	Bulk(Bag)	100

Refer to pages from p.176 to p.179 for mounting information.

■ Rated Value (□: packaging code)

Part Number	Common Mode Impedance (at 100MHz/20°C)	Rated Current	Rated Voltage	Insulation Resistance (min.)	Withstand Voltage	DC Resistance		
DLW5BTN101SQ2□	100ohm(Typ.)	6000mA	50Vdc	10M ohm	125Vdc	0.009ohm±40%	Kit	≥3A
DLW5BTN251SQ2□	250ohm(Typ.)	5000mA	50Vdc	10M ohm	125Vdc	0.014ohm±40%	Kit	≥3A
DLW5BTN501SQ2□	500ohm(Typ.)	4000mA	50Vdc	10M ohm	125Vdc	0.019ohm±40%	Kit	≥3A
DLW5BTN102SQ2□	1000ohm(Typ.)	2000mA	50Vdc	10M ohm	125Vdc	0.024ohm±40%	Kit	≥1A
DLW5BTN142SQ2□	1400ohm(Typ.)	1500mA	50Vdc	10M ohm	125Vdc	0.040ohm±40%	Kit	≥1A

Operating Temperature Range: -40°C to +85°C Number of Circuit: 1

■ Impedance-Frequency Characteristics (Main Items)

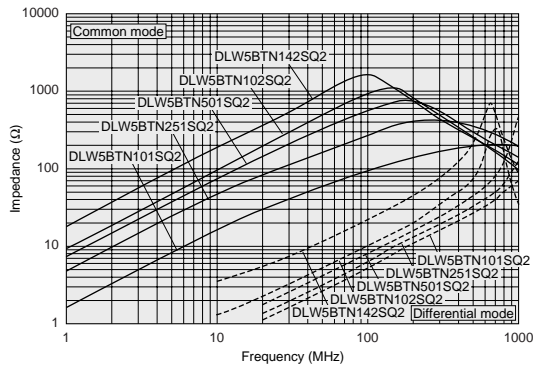

■ Derating of Rated Current

DLW5BTN101/251/501

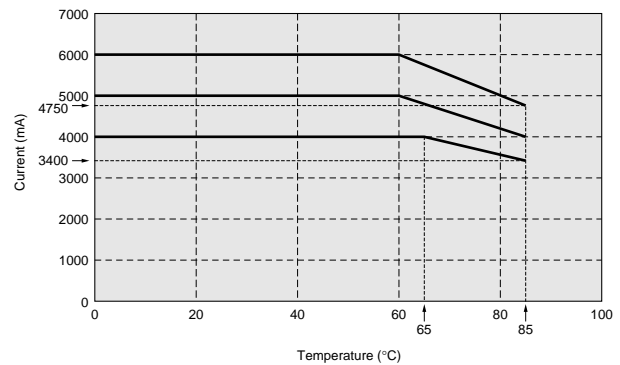

△Note • Please read rating and △CAUTION (for storage, operating, rating, soldering, mounting and handling) in this catalog to prevent smoking and/or burning, etc.
 • This catalog has only typical specifications because there is no space for detailed specifications. Therefore, please review our product specifications or consult the approval sheet for product specifications before ordering.

DLM11G Series (0504 Size)



Audio line common choke also effective to differential mode.



■ Dimensions

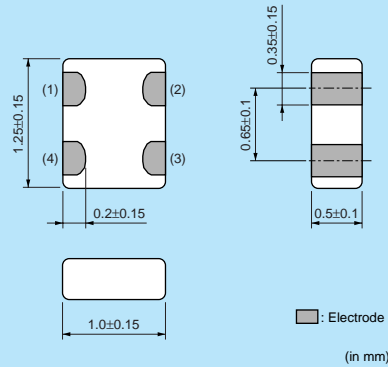

■ Equivalent Circuit

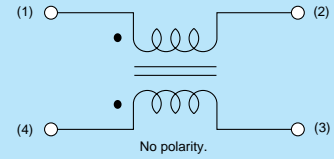

■ Packaging

Code	Packaging	Minimum Quantity
D	180mm Reel Paper Tape	10000
B	Bulk(Bag)	1000

Refer to pages from p.176 to p.179 for mounting information.

■ Rated Value (□: packaging code)

Part Number	Common Mode Impedance (at 100MHz/20°C)	Rated Current	Rated Voltage	Insulation Resistance (min.)	Withstand Voltage	DC Resistance
DLM11GN601SD2□	600ohm±25%	100mA	5Vdc	100M ohm	25Vdc	0.8ohm max.

Operating Temperature Range: -40°C to +85°C Number of Circuit: 1

■ Impedance-Frequency Characteristics (Main Items)

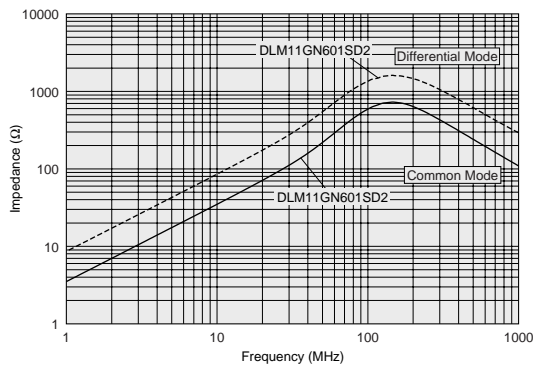

△Note • Please read rating and △CAUTION (for storage, operating, rating, soldering, mounting and handling) in this catalog to prevent smoking and/or burning, etc.
 • This catalog has only typical specifications because there is no space for detailed specifications. Therefore, please review our product specifications or consult the approval sheet for product specifications before ordering.

DLM2HG Series (1008 Size)



3 line audio common mode choke coil.

■ Dimensions

■ Equivalent Circuit

No polarity.

■ Packaging

Code	Packaging	Minimum Quantity
L	180mm Reel Embossed Tape	3000
B	Bulk(Bag)	1000

Refer to pages from p.176 to p.179 for mounting information.

■ Rated Value (□: packaging code)

Part Number	Common Mode Impedance (at 100MHz/20°C)	Rated Current	Rated Voltage	Insulation Resistance (min.)	Withstand Voltage	DC Resistance
DLM2HGN601SZ3□	600ohm±25%	100mA	16Vdc	100M ohm	100Vdc	0.40ohm max.

Operating Temperature Range: -55°C to +85°C Number of Circuit: 1

■ Impedance-Frequency Characteristics (Main Items)

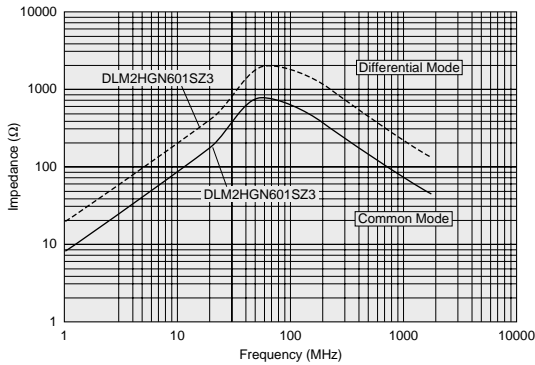

△Note • Please read rating and △CAUTION (for storage, operating, rating, soldering, mounting and handling) in this catalog to prevent smoking and/or burning, etc.
 • This catalog has only typical specifications because there is no space for detailed specifications. Therefore, please review our product specifications or consult the approval sheet for product specifications before ordering.

DLP0NS Series (03025 Size)



03025 size, very small chip common mode choke coil, Cut-off frequency 3GHz max.

■ Dimensions

(in mm)

■ Equivalent Circuit

No polarity.

■ Packaging

Code	Packaging	Minimum Quantity
L	180mm Reel Embossed Tape	5000
B	Bulk(Bag)	500

Refer to pages from p.176 to p.179 for mounting information.

■ Rated Value (□: packaging code)

Part Number	Common Mode Impedance (at 100MHz/20°C)	Rated Current	Rated Voltage	Insulation Resistance (min.)	Withstand Voltage	DC Resistance	
DLP0NSN670HL2□	67ohm±20%	110mA	5Vdc	100M ohm	12.5Vdc	2.4ohm±25%	Kit HD
DLP0NSN900HL2□	90ohm±20%	100mA	5Vdc	100M ohm	12.5Vdc	3.0ohm±25%	Kit HD
DLP0NSN121HL2□	120ohm±20%	90mA	5Vdc	100M ohm	12.5Vdc	3.8ohm±25%	Kit HD
DLP0NSA150HL2□	15ohm±5ohm	100mA	5Vdc	100M ohm	12.5Vdc	0.95ohm±25%	New Kit
DLP0NSC280HL2□	28ohm±20%	100mA	5Vdc	100M ohm	12.5Vdc	1.3ohm±25%	Kit

Operating Temperature Range: -40°C to +85°C Number of Circuit: 1

HD: for high speed differential signal lines UD: for ultra high speed differential signal lines

■ Impedance-Frequency Characteristics (Main Items)

DLP0NSN 670/900/121 HL2

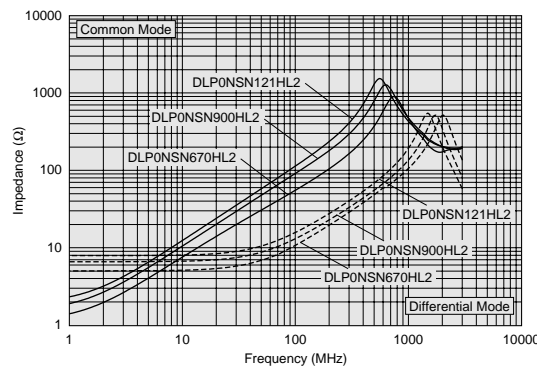

DLP0NSA150HL2/DLP0NSC280HL2

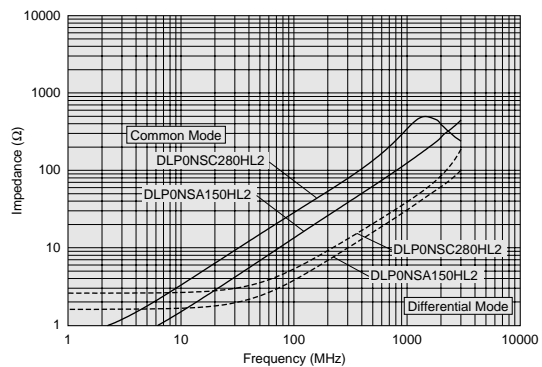

■ Differential Mode Transmission Characteristics (Typ.)

DLP0NSN900HL2

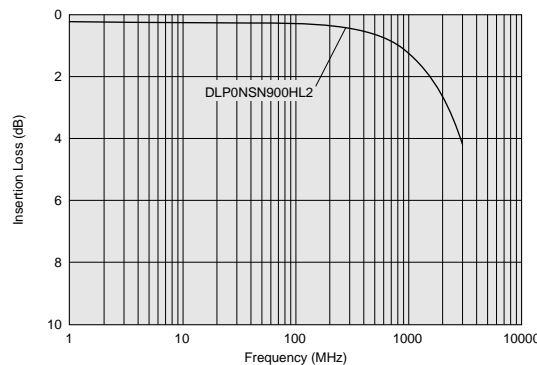

DLP0NSA150HL2

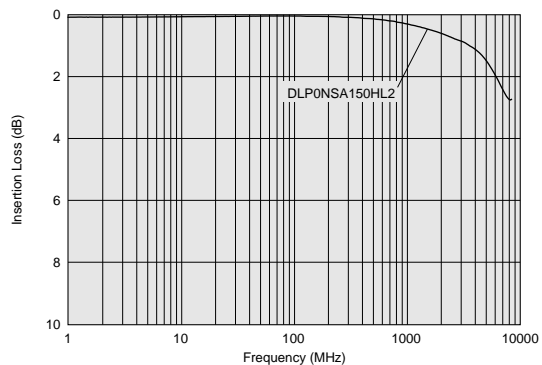

△Note • Please read rating and △CAUTION (for storage, operating, rating, soldering, mounting and handling) in this catalog to prevent smoking and/or burning, etc.
• This catalog has only typical specifications because there is no space for detailed specifications. Therefore, please review our product specifications or consult the approval sheet for product specifications before ordering.

Chip Ferrite Bead

Chip EMIFIL®

Chip Common Mode Choke Coil
Signal Lines Type

Block Type EMIFIL®

■ Differential Mode Transmission Characteristics (Typ.)

DLP0NSC280HL2

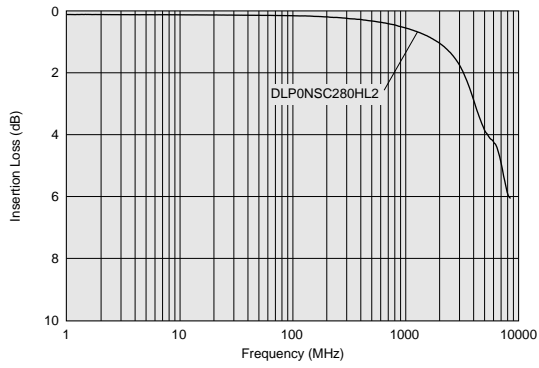

Chip Ferrite Bead

Chip EMIFIL®

Signal Lines Type
Chip Common Mode Choke Coil

Block Type EMIFIL®

⚠Note • Please read rating and ⚠CAUTION (for storage, operating, rating, soldering, mounting and handling) in this catalog to prevent smoking and/or burning, etc.
• This catalog has only typical specifications because there is no space for detailed specifications. Therefore, please review our product specifications or consult the approval sheet for product specifications before ordering.

DLP11S/DLP11T Series (0504 Size)



6GHz cut-off frequency (for HDMI) is available.

■ Dimensions

Part Number	T
DLP11S	0.82±0.1
DLP11T	0.3±0.05

■ : Electrode (in mm)

■ Equivalent Circuit

No polarity.

■ Packaging

Code	Packaging	Minimum Quantity
L	180mm Reel Embossed Tape	3000 (DLP11S) 5000 (DLP11T)
B	Bulk(Bag)	500

Refer to pages from p.176 to p.179 for mounting information.

■ Rated Value (□: packaging code)

Part Number	Common Mode Impedance (at 100MHz/20°C)	Rated Current	Rated Voltage	Insulation Resistance (min.)	Withstand Voltage	DC Resistance	
DLP11SN670SL2□	67ohm±20%	180mA	5Vdc	100M ohm	12.5Vdc	1.3ohm±25%	Kit HD
DLP11SN121SL2□	120ohm±20%	140mA	5Vdc	100M ohm	12.5Vdc	2.0ohm±25%	Kit HD
DLP11SN161SL2□	160ohm±20%	120mA	5Vdc	100M ohm	12.5Vdc	2.7ohm±25%	Kit HD
DLP11SN900HL2□	90ohm±20%	150mA	5Vdc	100M ohm	12.5Vdc	1.5ohm±25%	Kit HD
DLP11SN201HL2□	200ohm±20%	110mA	5Vdc	100M ohm	12.5Vdc	3.1ohm±25%	Kit HD
DLP11SN241HL2□	240ohm±20%	100mA	5Vdc	100M ohm	12.5Vdc	3.5ohm±25%	Kit HD
DLP11SN281HL2□	280ohm±20%	90mA	5Vdc	100M ohm	12.5Vdc	4.2ohm±25%	Kit HD
DLP11SN331HL2□	330ohm±20%	80mA	5Vdc	100M ohm	12.5Vdc	4.9ohm±25%	Kit HD
DLP11SA350HL2□	35ohm±20%	170mA	5Vdc	100M ohm	12.5Vdc	0.9ohm±25%	Kit
DLP11SA670HL2□	67ohm±20%	150mA	5Vdc	100M ohm	12.5Vdc	1.2ohm±25%	Kit
DLP11SA900HL2□	90ohm±20%	150mA	5Vdc	100M ohm	12.5Vdc	1.4ohm±25%	Kit

Operating Temperature Range: -40°C to +85°C Number of Circuit: 1

HD: for high speed differential signal lines

UD: for ultra high speed differential signal lines

■ Impedance-Frequency Characteristics

DLP11SN Series

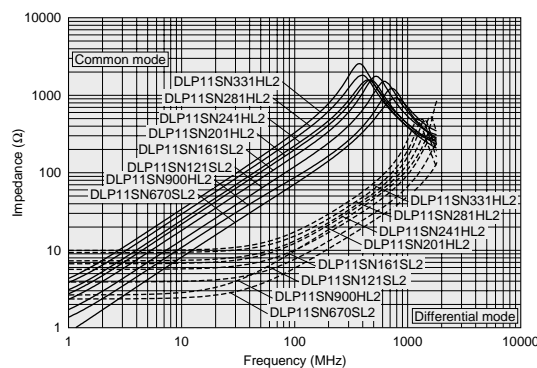

DLP11SA Series

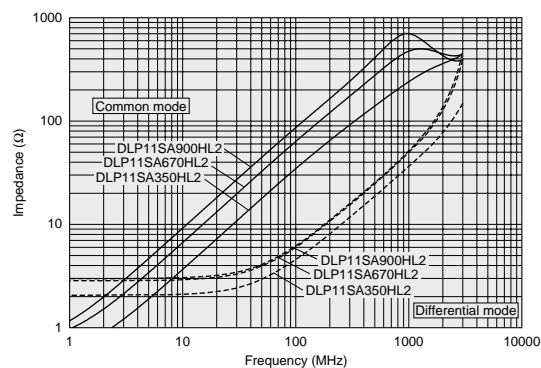

Continued on the following page. ↗

△Note • Please read rating and △CAUTION (for storage, operating, rating, soldering, mounting and handling) in this catalog to prevent smoking and/or burning, etc.
• This catalog has only typical specifications because there is no space for detailed specifications. Therefore, please review our product specifications or consult the approval sheet for product specifications before ordering.

■ Differential Mode Transmission Characteristics (Typ.)

DLP11SN Series

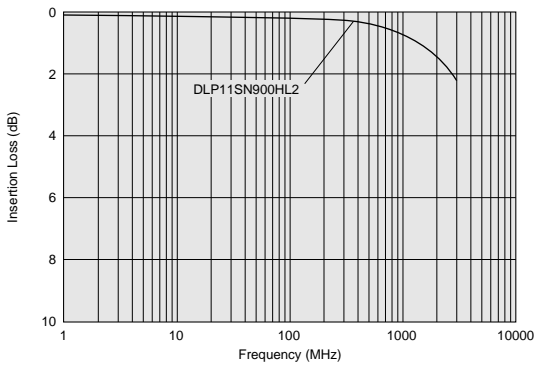

DLP11SA Series

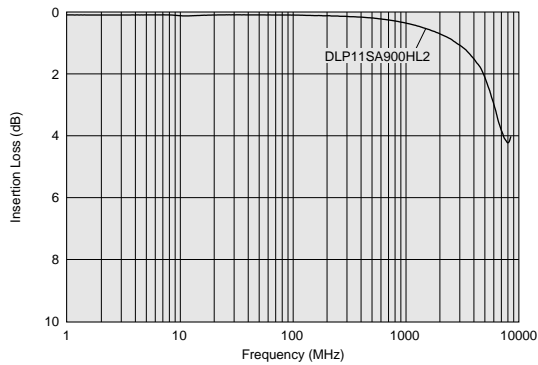

■ Rated Value (□: packaging code)

Part Number	Common Mode Impedance (at 100MHz/20°C)	Rated Current	Rated Voltage	Insulation Resistance (min.)	Withstand Voltage	DC Resistance	
DLP11TB800UL2□	80ohm±25%	100mA	5Vdc	100M ohm	12.5Vdc	1.5ohm±25%	New Kit UD

Operating Temperature Range: -40°C to +85°C Number of Circuit: 1
 Differential mode to common mode conversion characteristic (Scd21) at 2.5GHz: -40dB (typ.)
 Impedance Characteristics between signal lines Z0 (TDR at 50ps): 90ohm±15ohm

■ Impedance-Frequency Characteristics

DLP11TB Series

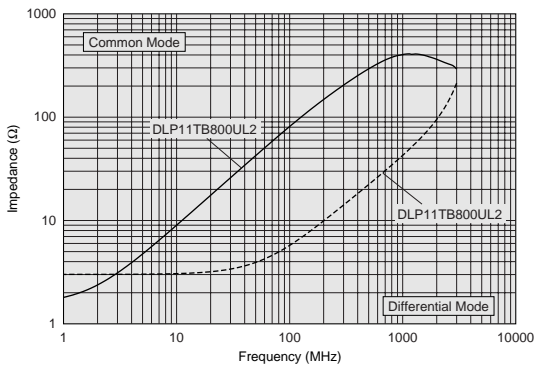

■ Differential Mode Transmission Characteristics

DLP11TB Series

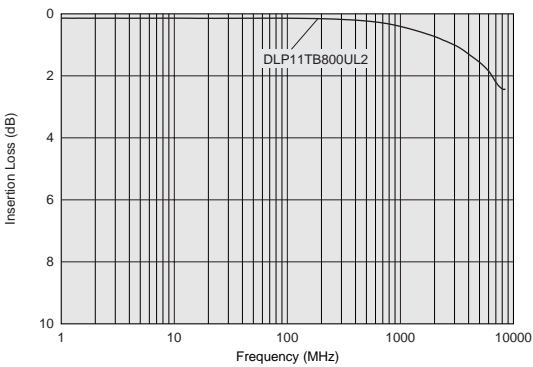

⚠Note • Please read rating and ⚠CAUTION (for storage, operating, rating, soldering, mounting and handling) in this catalog to prevent smoking and/or burning, etc.
 • This catalog has only typical specifications because there is no space for detailed specifications. Therefore, please review our product specifications or consult the approval sheet for product specifications before ordering.

DLP31S Series (1206 Size)



1206 size film type chip common mode choke coil.



■ Dimensions

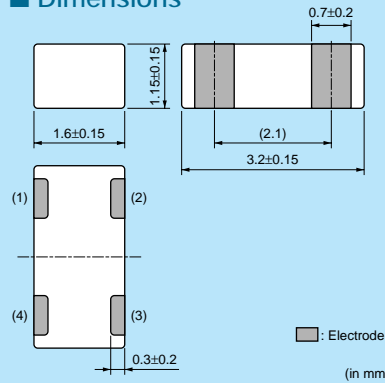

■ Equivalent Circuit

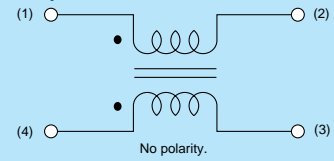

■ Packaging

Code	Packaging	Minimum Quantity
L	180mm Reel Embossed Tape	3000
B	Bulk(Bag)	500

Refer to pages from p.176 to p.179 for mounting information.

■ Rated Value (□: packaging code)

Part Number	Common Mode Impedance (at 100MHz/20°C)	Rated Current	Rated Voltage	Insulation Resistance (min.)	Withstand Voltage	DC Resistance	
DLP31SN121ML2□	120ohm±20%	100mA	16Vdc	100M ohm	40Vdc	2.0ohm max.	HD
DLP31SN221ML2□	220ohm±20%	100mA	16Vdc	100M ohm	40Vdc	2.5ohm max.	HD
DLP31SN551ML2□	550ohm±20%	100mA	16Vdc	100M ohm	40Vdc	3.6ohm max.	HD

Operating Temperature Range: -40°C to +85°C Number of Circuit: 1

HD: for high speed differential signal lines UD: for ultra high speed differential signal lines

■ Impedance-Frequency Characteristics (Main Items)

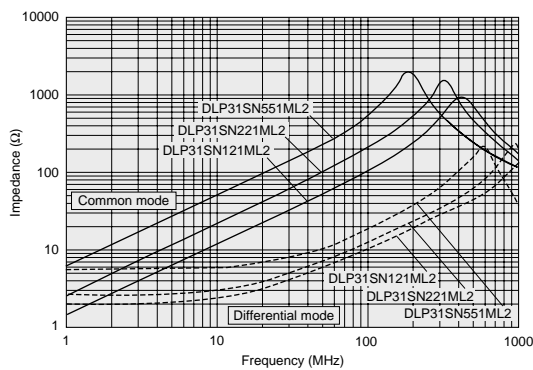

△Note • Please read rating and △CAUTION (for storage, operating, rating, soldering, mounting and handling) in this catalog to prevent smoking and/or burning, etc.
• This catalog has only typical specifications because there is no space for detailed specifications. Therefore, please review our product specifications or consult the approval sheet for product specifications before ordering.

DLP1ND Series (0502 Size)



2 circuits in 05025 size, adapt to HDMI line.

■ Dimensions

0.2±0.1, 0.4±0.1, 0.45±0.05, 0.2±0.1, 0.1 min., 0.65±0.1, 1.5±0.1

■ Electrode (in mm)

■ Equivalent Circuit

No polarity.

■ Packaging

Code	Packaging	Minimum Quantity
L	180mm Reel Embossed Tape	5000
B	Bulk(Bag)	500

Refer to pages from p.176 to p.179 for mounting information.

■ Rated Value (□: packaging code)

Part Number	Common Mode Impedance (at 100MHz/20°C)	Rated Current	Rated Voltage	Insulation Resistance (min.)	Withstand Voltage	DC Resistance	
DLP1NDN350HL4□	35ohm±20%	100mA	5Vdc	100M ohm	12.5Vdc	1.8ohm±25%	New Kit UD
DLP1NDN670HL4□	67ohm±20%	80mA	5Vdc	100M ohm	12.5Vdc	2.9ohm±25%	New Kit UD
DLP1NDN900HL4□	90ohm±20%	60mA	5Vdc	100M ohm	12.5Vdc	3.7ohm±25%	New Kit UD

Operating Temperature Range: -40°C to +85°C Number of Circuit: 2

HD: for high speed differential signal lines

UD: for ultra high speed differential signal lines

■ Impedance-Frequency Characteristics

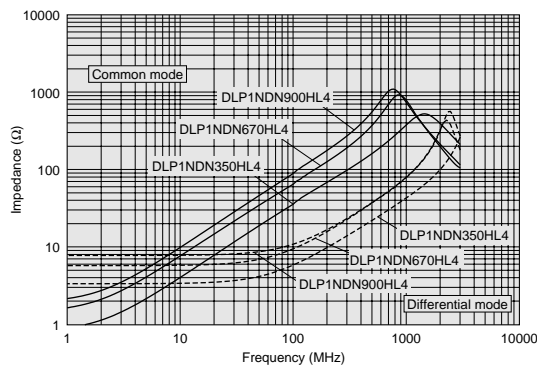

■ Differential Mode Transmission Characteristics

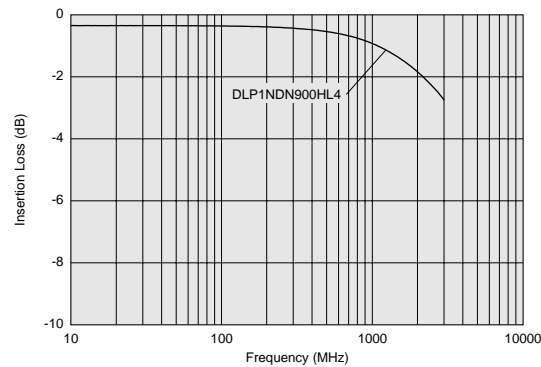

⚠Note • Please read rating and ⚠CAUTION (for storage, operating, rating, soldering, mounting and handling) in this catalog to prevent smoking and/or burning, etc.
 • This catalog has only typical specifications because there is no space for detailed specifications. Therefore, please review our product specifications or consult the approval sheet for product specifications before ordering.

DLP2AD Series (0804 Size)



2 circuit built-in, 0804 size, HDMI adapted type available, cut-off frequency 6GHz max.



■ Dimensions

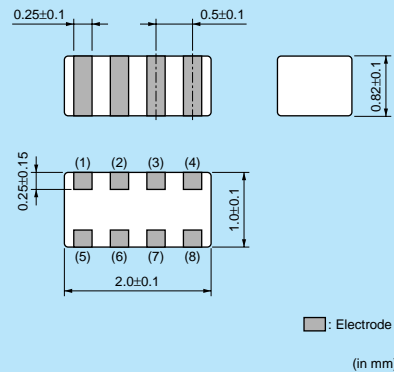

■ Equivalent Circuit

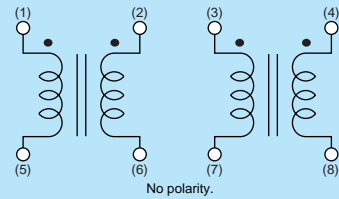

■ Packaging

Code	Packaging	Minimum Quantity
L	180mm Reel Embossed Tape	3000
B	Bulk(Bag)	500

Refer to pages from p.176 to p.179 for mounting information.

■ Rated Value (□: packaging code)

Part Number	Common Mode Impedance (at 100MHz/20°C)	Rated Current	Rated Voltage	Insulation Resistance (min.)	Withstand Voltage	DC Resistance	Kit	UD	Imp Match
DLP2ADA350HL4□	35ohm±20%	150mA	5Vdc	100M ohm	12.5Vdc	0.8ohm±25%	Kit	UD	Imp Match
DLP2ADA670HL4□	67ohm±20%	130mA	5Vdc	100M ohm	12.5Vdc	1.0ohm±25%	Kit	UD	Imp Match
DLP2ADA900HL4□	90ohm±20%	120mA	5Vdc	100M ohm	12.5Vdc	1.4ohm±25%	Kit	UD	Imp Match
DLP2ADN670HL4□	67ohm±20%	140mA	5Vdc	100M ohm	12.5Vdc	1.3ohm±25%	Kit	HD	Imp Match
DLP2ADN900HL4□	90ohm±20%	130mA	5Vdc	100M ohm	12.5Vdc	1.7ohm±25%	Kit	HD	Imp Match
DLP2ADN121HL4□	120ohm±20%	120mA	5Vdc	100M ohm	12.5Vdc	2.0ohm±25%	Kit	HD	Imp Match
DLP2ADN161HL4□	160ohm±20%	100mA	5Vdc	100M ohm	12.5Vdc	2.5ohm±25%	Kit	HD	Imp Match
DLP2ADN201HL4□	200ohm±20%	90mA	5Vdc	100M ohm	12.5Vdc	3.2ohm±25%	Kit	HD	Imp Match
DLP2ADN241HL4□	240ohm±20%	80mA	5Vdc	100M ohm	12.5Vdc	3.8ohm±25%	Kit	HD	Imp Match
DLP2ADN281HL4□	280ohm±20%	80mA	5Vdc	100M ohm	12.5Vdc	4.6ohm±25%	Kit	HD	Imp Match

Operating Temperature Range: -40°C to +85°C Number of Circuit: 2

HD: for high speed differential signal lines

UD: for ultra high speed differential signal lines

■ Impedance-Frequency Characteristics (Main Items)

DLP2ADA Series

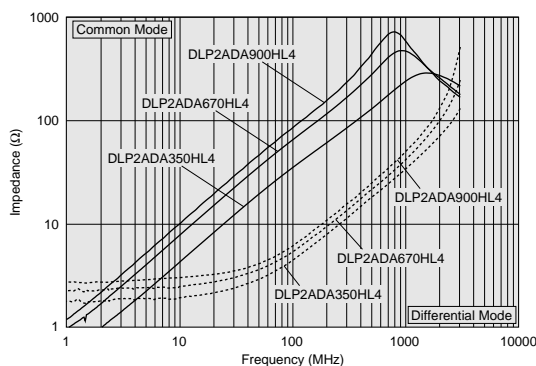

DLP2ADN Series

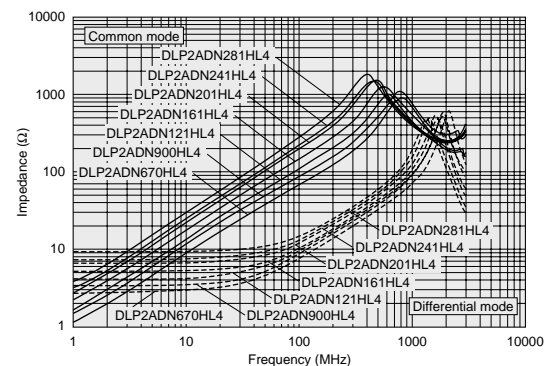

Continued on the following page. ↗

△Note • Please read rating and △CAUTION (for storage, operating, rating, soldering, mounting and handling) in this catalog to prevent smoking and/or burning, etc.
 • This catalog has only typical specifications because there is no space for detailed specifications. Therefore, please review our product specifications or consult the approval sheet for product specifications before ordering.

■ Differential Mode Transmission Characteristics (Typ.)

DLP2ADA Series

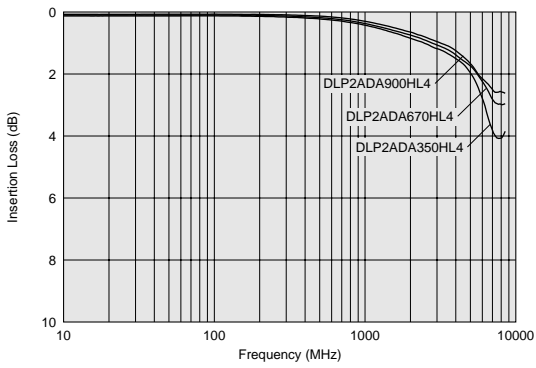

DLP2ADN Series

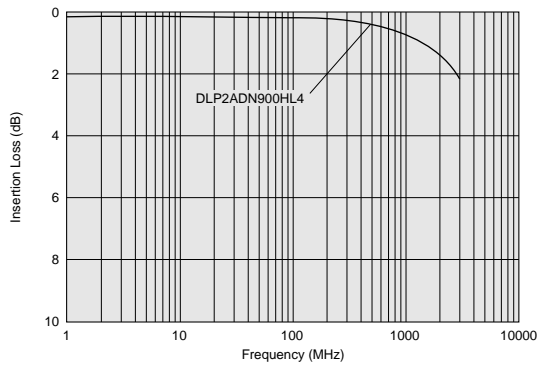

⚠Note • Please read rating and ⚠CAUTION (for storage, operating, rating, soldering, mounting and handling) in this catalog to prevent smoking and/or burning, etc.
 • This catalog has only typical specifications because there is no space for detailed specifications. Therefore, please review our product specifications or consult the approval sheet for product specifications before ordering.

DLP31D Series (1206 Size)



2 circuit built-in, 1206 size, meet IEEE1394,USB,LVDS.



Dimensions

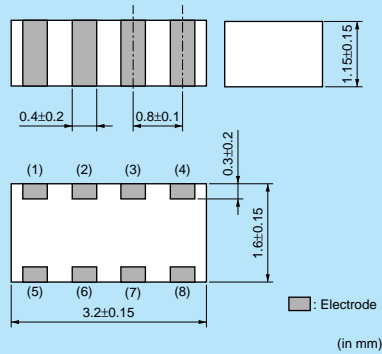

Equivalent Circuit

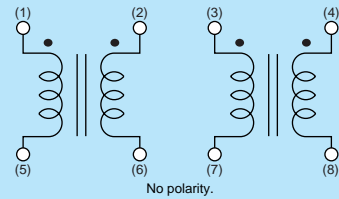

Packaging

Code	Packaging	Minimum Quantity
L	180mm Reel Embossed Tape	3000
B	Bulk(Bag)	500

Refer to pages from p.176 to p.179 for mounting information.

Rated Value (□: packaging code)

Part Number	Common Mode Impedance (at 100MHz/20°C)	Rated Current	Rated Voltage	Insulation Resistance (min.)	Withstand Voltage	DC Resistance	
DLP31DN900ML4□	90ohm±20%	160mA	10Vdc	100M ohm	25Vdc	1.1ohm max.	HD
DLP31DN131ML4□	130ohm±20%	120mA	10Vdc	100M ohm	25Vdc	1.1ohm max.	HD
DLP31DN201ML4□	200ohm±20%	100mA	10Vdc	100M ohm	25Vdc	2.2ohm max.	HD
DLP31DN321ML4□	320ohm±20%	80mA	10Vdc	100M ohm	25Vdc	3.5ohm max.	HD
DLP31DN441ML4□	440ohm±20%	70mA	10Vdc	100M ohm	25Vdc	4.3ohm max.	HD

Operating Temperature Range: -40°C to +85°C Number of Circuit: 2

HD: for high speed differential signal lines UD: for ultra high speed differential signal lines

Impedance-Frequency Characteristics (Main Items)

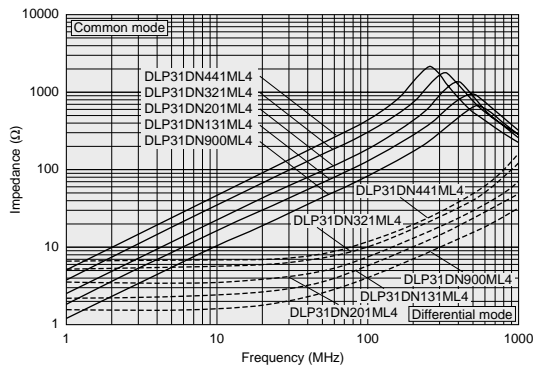

Note • Please read rating and CAUTION (for storage, operating, rating, soldering, mounting and handling) in this catalog to prevent smoking and/or burning, etc.
 • This catalog has only typical specifications because there is no space for detailed specifications. Therefore, please review our product specifications or consult the approval sheet for product specifications before ordering.

DLW21S Series (0805 Size)



Wire-wound common choke, HDMI available type prepaired.

■ Dimensions

(in mm)

■ Equivalent Circuit

No polarity.

■ Packaging

Code	Packaging	Minimum Quantity
L	180mm Reel Embossed Tape	2000
B	Bulk(Bag)	500

Refer to pages from p.176 to p.179 for mounting information.

■ Rated Value (□: packaging code)

Part Number	Common Mode Impedance (at 100MHz/20°C)	Rated Current	Rated Voltage	Insulation Resistance (min.)	Withstand Voltage	DC Resistance	
DLW21SN670SQ2□	67ohm±25%	400mA	50Vdc	10M ohm	125Vdc	0.25ohm max.	Kit HD
DLW21SN900SQ2□	90ohm±25%	330mA	50Vdc	10M ohm	125Vdc	0.35ohm max.	Kit HD
DLW21SN121SQ2□	120ohm±25%	370mA	50Vdc	10M ohm	125Vdc	0.45ohm max.	Kit HD
DLW21SN181SQ2□	180ohm±25%	330mA	50Vdc	10M ohm	125Vdc	0.35ohm max.	Kit HD
DLW21SN261SQ2□	260ohm±25%	300mA	50Vdc	10M ohm	125Vdc	0.40ohm max.	Kit HD
DLW21SN371SQ2□	370ohm±25%	280mA	50Vdc	10M ohm	125Vdc	0.45ohm max.	Kit HD
DLW21SN670HQ2□	67ohm±25%	320mA	20Vdc	10M ohm	50Vdc	0.31ohm max.	Kit UD
DLW21SN900HQ2□	90ohm±25%	280mA	20Vdc	10M ohm	50Vdc	0.41ohm max.	Kit UD
DLW21SN121HQ2□	120ohm±25%	280mA	20Vdc	10M ohm	50Vdc	0.41ohm max.	Kit UD
DLW21SR670HQ2□	67ohm±25%	400mA	20Vdc	10M ohm	50Vdc	0.25ohm max.	Kit UD

Operating Temperature Range: -40°C to +85°C Number of Circuit: 1 HD: for high speed differential signal lines UD: for ultra high speed differential signal lines
 DLW21SR670HQ2 is designed to correct line impedance when ESD protection device is also used.

■ Impedance-Frequency Characteristics (Main Items)

DLW21SN_SQ2 Series

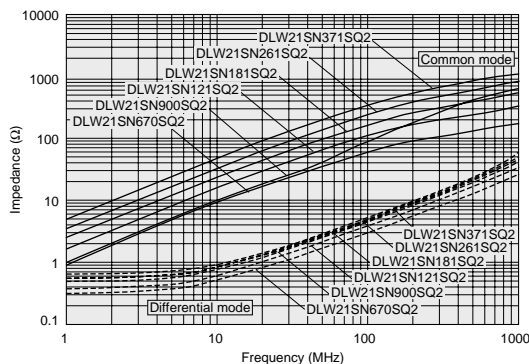

DLW21SN_HQ2 Series

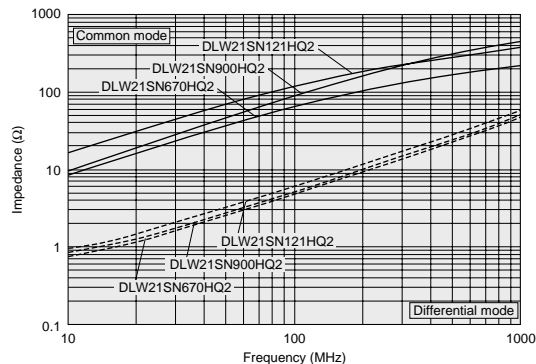

Continued on the following page. ↗

△Note • Please read rating and △CAUTION (for storage, operating, rating, soldering, mounting and handling) in this catalog to prevent smoking and/or burning, etc.
 • This catalog has only typical specifications because there is no space for detailed specifications. Therefore, please review our product specifications or consult the approval sheet for product specifications before ordering.

■ Impedance-Frequency Characteristics (Main Items)

DLW21SR_HQ2 Series

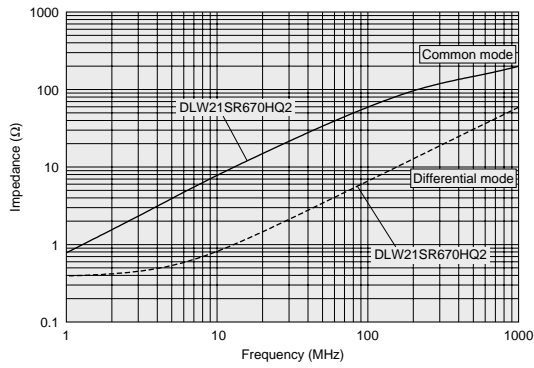

■ Differential Mode Transmission Characteristics (Typ.)

DLW21SN_HQ2 Series

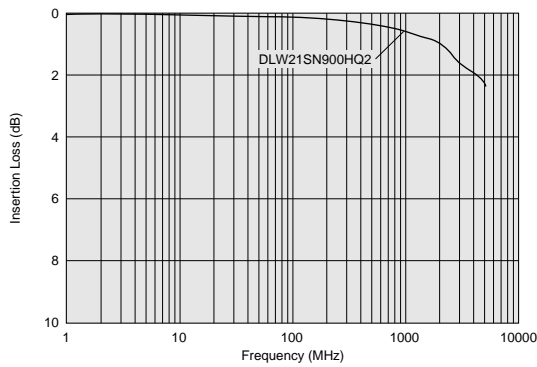

△Note • Please read rating and △CAUTION (for storage, operating, rating, soldering, mounting and handling) in this catalog to prevent smoking and/or burning, etc.
 • This catalog has only typical specifications because there is no space for detailed specifications. Therefore, please review our product specifications or consult the approval sheet for product specifications before ordering.

Chip Ferrite Bead
 Chip EMIFIL®
 Chip Common Mode Choke Coil
 Signal Lines Type
 Block Type EMIFIL®

DLW21H Series (0805 Size)



Low profile wire-wound common choke coil.

■ Dimensions

(in mm)

■ Equivalent Circuit

No polarity.

■ Packaging

Code	Packaging	Minimum Quantity
L	180mm Reel Embossed Tape	3000
B	Bulk(Bag)	500

Refer to pages from p.176 to p.179 for mounting information.

■ Rated Value (□: packaging code)

Part Number	Common Mode Impedance (at 100MHz/20°C)	Rated Current	Rated Voltage	Insulation Resistance (min.)	Withstand Voltage	DC Resistance	
DLW21HN670SQ2□	67ohm±25%	330mA	50Vdc	10M ohm	125Vdc	0.35ohm max.	Kit HD
DLW21HN900SQ2□	90ohm±25%	330mA	50Vdc	10M ohm	125Vdc	0.35ohm max.	Kit HD
DLW21HN121SQ2□	120ohm±25%	280mA	50Vdc	10M ohm	125Vdc	0.45ohm max.	Kit HD
DLW21HN181SQ2□	180ohm±25%	250mA	50Vdc	10M ohm	125Vdc	0.50ohm max.	Kit HD

Operating Temperature Range: -40°C to +85°C Number of Circuit: 1

HD: for high speed differential signal lines UD: for ultra high speed differential signal lines

■ Impedance-Frequency Characteristics (Main Items)

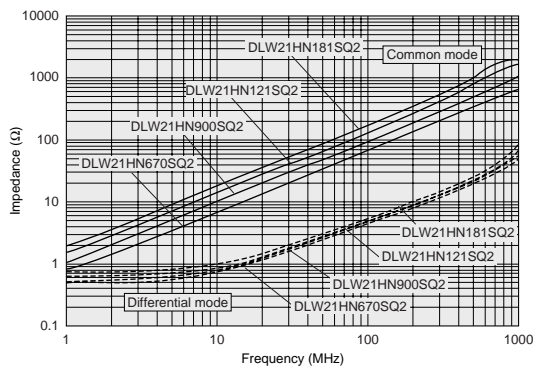

△Note • Please read rating and △CAUTION (for storage, operating, rating, soldering, mounting and handling) in this catalog to prevent smoking and/or burning, etc.
 • This catalog has only typical specifications because there is no space for detailed specifications. Therefore, please review our product specifications or consult the approval sheet for product specifications before ordering.

DLW31S Series (1206 Size)



1206 size wire-wound common mode choke coil.



■ Dimensions

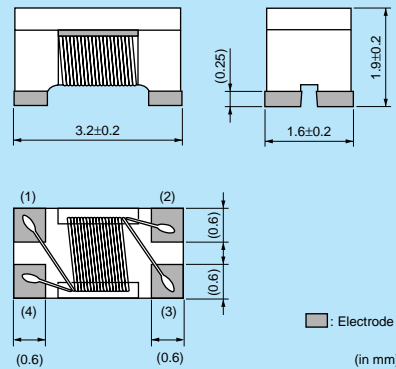

■ Equivalent Circuit

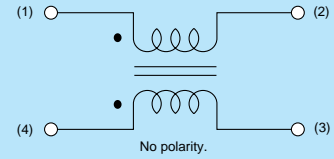

■ Packaging

Code	Packaging	Minimum Quantity
L	180mm Reel Embossed Tape	2000
B	Bulk(Bag)	500

Refer to pages from p.176 to p.179 for mounting information.

■ Rated Value (□: packaging code)

Part Number	Common Mode Impedance (at 100MHz/20°C)	Rated Current	Rated Voltage	Insulation Resistance (min.)	Withstand Voltage	DC Resistance	
DLW31SN900SQ2□	90ohm±25%	370mA	50Vdc	10M ohm	125Vdc	0.3ohm max.	HD
DLW31SN161SQ2□	160ohm±25%	340mA	50Vdc	10M ohm	125Vdc	0.4ohm max.	HD
DLW31SN261SQ2□	260ohm±25%	310mA	50Vdc	10M ohm	125Vdc	0.5ohm max.	HD
DLW31SN601SQ2□	600ohm±25%	260mA	50Vdc	10M ohm	125Vdc	0.8ohm max.	HD
DLW31SN102SQ2□	1000ohm±25%	230mA	50Vdc	10M ohm	125Vdc	1.0ohm max.	HD
DLW31SN222SQ2□	2200ohm±25%	200mA	50Vdc	10M ohm	125Vdc	1.2ohm max.	HD

Operating Temperature Range: -40°C to +85°C Number of Circuit: 1

HD: for high speed differential signal lines UD: for ultra high speed differential signal lines

■ Impedance-Frequency Characteristics

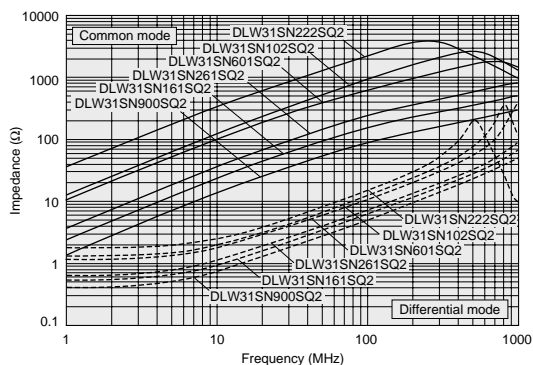

△Note • Please read rating and △CAUTION (for storage, operating, rating, soldering, mounting and handling) in this catalog to prevent smoking and/or burning, etc.
• This catalog has only typical specifications because there is no space for detailed specifications. Therefore, please review our product specifications or consult the approval sheet for product specifications before ordering.

PLT10H Series (12.9x6.6 mm)



Automotive available, up to 10A.

■ Dimensions

Legend: Electrode (in mm)

■ Equivalent Circuit

No polarity.

■ Packaging

Code	Packaging	Minimum Quantity
L	180mm Reel Embossed Tape	125
K	330mm Reel Embossed Tape	500
B	Bulk (Bag)	50

Refer to pages from p.180 to p.181 for mounting information.

■ Rated Value (□: packaging code)

Part Number	Common Mode Impedance (at 10MHz/20°C)	Rated Current	Rated Voltage	Insulation Resistance (min.)	Withstand Voltage	DC Resistance	Common Mode Inductance	
PLT10HH401100PN□	400ohm	10A	100Vdc	10M ohm	250Vdc	3.6m ohm±0.5m ohm	6μH min.	New Kit ≥10A
PLT10HH501100PN□	500ohm	10A	100Vdc	10M ohm	250Vdc	3.6m ohm±0.5m ohm	9μH min.	New Kit ≥10A
PLT10HH9016R0PN□	900ohm	6A	100Vdc	10M ohm	250Vdc	8.0m ohm±0.5m ohm	14μH min.	New Kit ≥3A
PLT10HH1026R0PN□	1000ohm	6A	100Vdc	10M ohm	250Vdc	8.0m ohm±0.5m ohm	20μH min.	New Kit ≥3A

Operating Temperature Range (Self-temperature rise is included): -55°C to +105°C (PLT10HH 1026R0/501100 PN), -55°C to +105°C (PLT10HH 401100/9016R0 PN) Number of Circuit: 1

■ Impedance-Frequency Characteristics

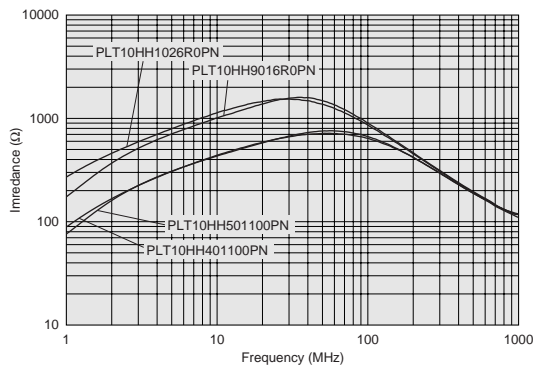

■ Notice (Rating)

In operating temperature exceeding +65°C, derating of current is necessary for PLT10H Series.

Please apply the derating curve shown in chart according to the operating temperature.

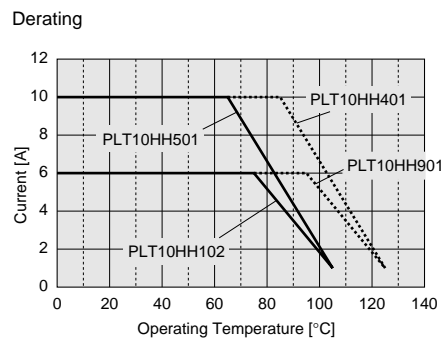

△Note • Please read rating and △CAUTION (for storage, operating, rating, soldering, mounting and handling) in this catalog to prevent smoking and/or burning, etc.
 • This catalog has only typical specifications because there is no space for detailed specifications. Therefore, please review our product specifications or consult the approval sheet for product specifications before ordering.

⚠ Caution

● Rating

Do not use products beyond the rated current and rated voltage as this may create excessive heat and deteriorate the insulation resistance.

● Soldering and Mounting

1. Self-heating

Please provide special attention when mounting chip common mode choke coils DLW5 series in close proximity to other products that radiate heat. The heat generated by other products may deteriorate the insulation resistance and cause excessive heat in this component.

2. Mounting Direction

Mount Chip Common Mode Choke Coils in right direction. Wrong direction, which is 90 degrees rotated from right direction, causes not only open or short circuit but also flames or other serious trouble.

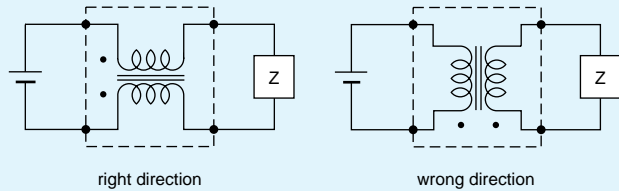

● Storage and Operating Conditions

<Operating Environment>

Do not use products in a chemical atmosphere such as chlorine gas, acid or sulfide gas. Do not use products in the environment close to the organic solvent.

<Storage and Handling Requirements>

1. Storage Period

DLW11G/DLM2HG series should be used within 6 months, the other series should be used within 12 months. Solderability should be checked if this period is exceeded.

2. Storage Conditions

- (1) Storage temperature: -10 to +40°C
Relative humidity: 15 to 85%
Avoid sudden changes in temperature and humidity.
- (2) Do not store products in a chemical atmosphere such as chlorine gas, acid or sulfide gas.

● Notice (Soldering and Mounting)

1. Cleaning

Failure and degradation of a product are caused by the cleaning method. When you clean in conditions that are not in mounting information, please contact Murata engineering.

2. Soldering

Reliability decreases with improper soldering methods. Please solder by the standard soldering conditions shown in mounting information.

3. Other

Noise suppression levels resulting from Murata's EMI suppression filters EMIFIL® may vary, depending on the circuits and ICs used, type of noise, mounting pattern, mounting location, and other operating conditions. Be sure to check and confirm in advance the noise suppression effect of each filter, in actual circuits, etc. before applying the filter in a commercial-purpose equipment design.

Notice

● Handling

1. Resin Coating (Except DLW Series.)

Using resin for coating/molding products may affect the products performance. So please pay careful attention in selecting resin. Prior to use, please make the reliability evaluation with the product mounted in your application set.

2. Resin Coating (DLW Series)

The impedance value may change due to high cure-stress of resin to be used for coating/molding products. An open circuit issue may occur by mechanical stress caused by the resin, amount/cured shape of resin, or operating condition etc. Some resin contains some impurities or chloride possible to generate chlorine by hydrolysis under some operating condition may cause corrosion of wire of coil, leading to open circuit. So, please pay your careful attention in selecting resin in case of coating/molding the products with the resin. Prior to use the coating resin, please make sure no reliability issue is observed by evaluating products mounted on your board.

3. Caution for Use (DLW Series)

When you hold products with a tweezer, please hold by the sides. Sharp materials, such as a pair of tweezers, should not touch the winding portion to prevent breaking the wire. Mechanical shock should not be applied to the products mounted on the board to prevent breaking the core.

4. Brushing

When you clean the neighborhood of products such as connector pins, bristles of cleaning brush shall not be touched to the winding portion of this product to prevent the breaking of wire.

5. Handling of a Substrate

After mounting products on a substrate, do not apply any stress to the product caused by bending or twisting to the substrate when cropping the substrate, inserting and removing a connector from the substrate or tightening screw to the substrate. Excessive mechanical stress may cause cracking in the Product.

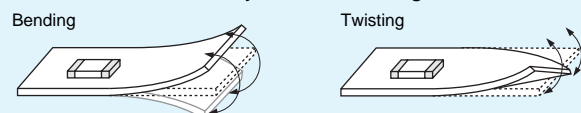

⚠ Note • Please read rating and ⚠ CAUTION (for storage, operating, rating, soldering, mounting and handling) in this catalog to prevent smoking and/or burning, etc.
• This catalog has only typical specifications because there is no space for detailed specifications. Therefore, please review our product specifications or consult the approval sheet for product specifications before ordering.

⚠ Caution

● Rating

1. Do not use products beyond the rated current and rated voltage as this may create excessive heat and deteriorate the insulation resistance.
2. Be sure to provide an appropriate fail-safe function on your product to prevent a second damage that may be caused by the abnormal function or the failure our product.

● Soldering and Mounting

1. Self-heating

Please provide special attention when mounting chip common mode choke coils in close proximity to other products that radiate heat. The heat generated by other products may deteriorate the insulation resistance and cause excessive heat in this component.

2. Mounting Direction

Mount Chip Common Mode Choke Coils in right direction. Wrong direction, which is 90 degrees rotated from right direction, causes not only open or short circuit but also flames or other serious trouble.

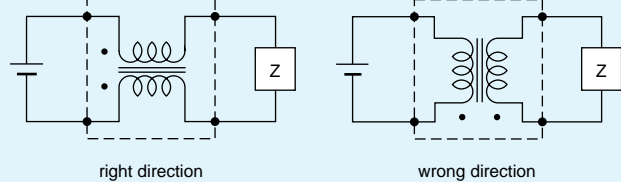

Notice

● Storage and Operating Conditions

<Operating Environment>

Do not use products in a chemical atmosphere such as chlorine gas, acid or sulfide gas.

Do not use products in the environment close to the organic solvent.

<Storage and Handling Requirements>

1. Storage Period

PLT10H series should be used within 12 months. Solderability should be checked if this period is exceeded.

2. Storage Conditions

- (1) Storage temperature: -10 to +40°C
Relative humidity: 15 to 85%
Avoid sudden changes in temperature and humidity.
- (2) Do not store products in a chemical atmosphere such as chlorine gas, acid or sulfide gas.

● Notice (Soldering and Mounting)

1. Cleaning

Failure and degradation of a product are caused by the cleaning method. When you clean in conditions that are not in mounting information, please contact Murata engineering.

2. Soldering

Reliability decreases with improper soldering methods. Please solder by the standard soldering conditions shown in mounting information.

3. Other

Noise suppression levels resulting from Murata's EMI suppression filters EMIFIL® may vary, depending on the circuits and ICs used, type of noise, mounting pattern, mounting location, and other operating conditions. Be sure to check and confirm in advance the noise suppression effect of each filter, in actual circuits, etc. before applying the filter in a commercial-purpose equipment design.

● Handling

1. Handling of a Substrate

After mounting products on a substrate, do not apply any stress to the product caused by bending or twisting to the substrate when cropping the substrate, inserting and removing a connector from the substrate or tightening screw to the substrate.

Excessive mechanical stress may cause cracking in the Product.

Bending

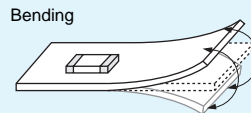

Twisting

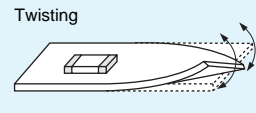

⚠ Note • Please read rating and ⚠ CAUTION (for storage, operating, rating, soldering, mounting and handling) in this catalog to prevent smoking and/or burning, etc.
• This catalog has only typical specifications because there is no space for detailed specifications. Therefore, please review our product specifications or consult the approval sheet for product specifications before ordering.

1. Standard Land Pattern Dimensions

Land Pattern + Solder Resist
 Land Pattern
 Solder Resist (in mm)

DLM11G
DLM2HG
DLP0NS
DLP11S
DLP11T
DLP1ND
DLP2AD
DLP31S
DLP31D
DLW21S
DLW21H
DLW31SN
DLW5AH
DLW5B

● Reflow and Flow

DLM2HG

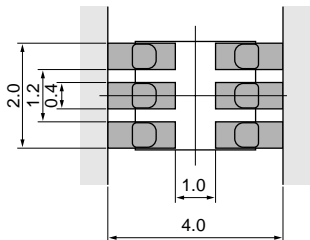

DLP31S

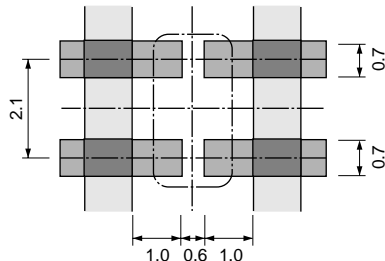

DLP31D

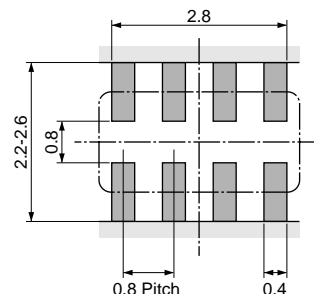

● Reflow Soldering

DLP0NS

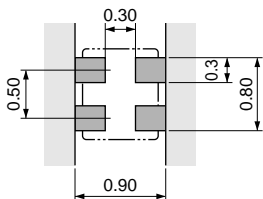

DLP11S

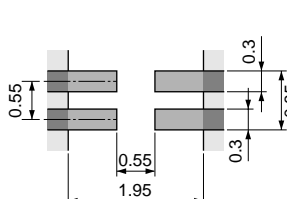

DLP11T

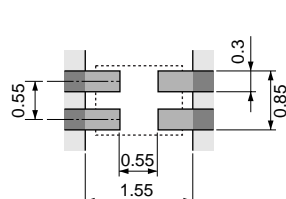

DLP1ND

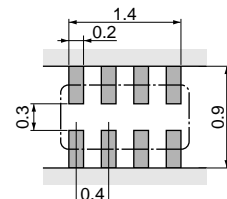

DLP2AD

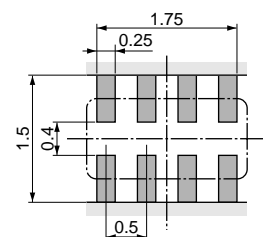

DLM11G

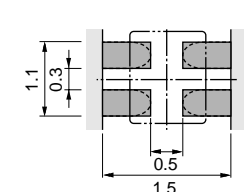

DLW21S/21H/31SN

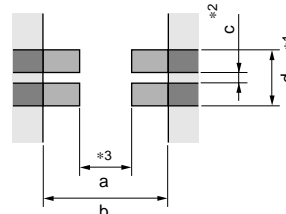

DLW5AH/5B

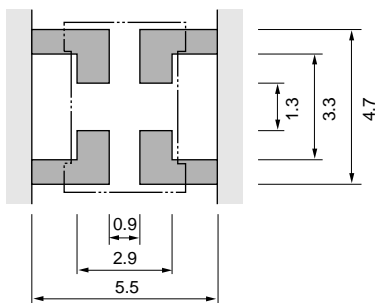

Series	a	b	c	d
DLW21S/H	0.8	2.6	0.4	1.2
DLW31SN	1.6	3.7	0.4	1.6

- *1: If the pattern is made with wider than 1.2mm (DLW21) / 1.6mm (DLW31S) it may result in components turning around, because melting speed is different. In the worst case, short circuit between lines may occur.
- *2: If the pattern is made with less than 0.4mm, in the worst case, short circuit between lines may occur due to spread of soldering paste or mount placing accuracy.
- *3: If the pattern is made with wider than 0.8mm (DLW21) / 1.6mm (DLW31SN), the bending strength will be reduced. Do not use gild pattern; excess soldering heat may dissolve metal of a copper wire.

● PCB Warping

PCB should be designed so that products are not subjected to the mechanical stress caused by warping the board.

Products should be located in the sideways direction (Length: a<b) to the mechanical stress.

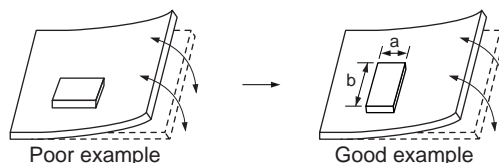

△Note • Please read rating and △CAUTION (for storage, operating, rating, soldering, mounting and handling) in this catalog to prevent smoking and/or burning, etc.
 • This catalog has only typical specifications because there is no space for detailed specifications. Therefore, please review our product specifications or consult the approval sheet for product specifications before ordering.

2. Solder Paste Printing and Adhesive Application

When reflow soldering the chip common mode choke coils, the printing must be conducted in accordance with the following cream solder printing conditions.

If too much solder is applied, the chip will be prone to damage by mechanical and thermal stress from the PCB and may crack.

Standard land dimensions should be used for resist and copper foil patterns.

When flow soldering the chip common mode choke coils, apply the adhesive in accordance with the following conditions.

If too much adhesive is applied, then it may overflow into the land or termination areas and yield poor solderability. In contrast, if insufficient adhesive is applied, or if the adhesive is not sufficiently hardened, then the chip may become detached during flow soldering process.

(in mm)

Series	Solder Paste Printing	Adhesive Application																																																		
<p>DLP DLW DLM</p>	<p>●Guideline of solder paste thickness: 100-150µm: DLW21S/21H/31S, DLP0NS/11S/11T/1ND/2AD/DLM11G 150-200µm: DLP31D/31S, DLM2HG, DLW5AH/5BS/5BT</p> <p>*Solderability is subject to reflow conditions and thermal conductivity. Please make sure that your product has been evaluated in view of your specifications with our product being mounted to your product.</p> <div style="display: flex; justify-content: space-around;"> <div data-bbox="336 965 644 1144"> <p>DLP0NS/11S/11T/31S/DLM11G</p> </div> <div data-bbox="676 965 906 1144"> <p>DLW21S/21H/31S</p> </div> </div> <table border="1" data-bbox="341 1178 616 1384"> <thead> <tr> <th>Series</th> <th>a</th> <th>b</th> <th>c</th> <th>d</th> </tr> </thead> <tbody> <tr> <td>DLP0NS</td> <td>0.3</td> <td>0.3</td> <td>0.3</td> <td>0.5</td> </tr> <tr> <td>DLP11S</td> <td>0.7</td> <td>0.55</td> <td>0.3</td> <td>0.55</td> </tr> <tr> <td>DLP11T</td> <td>0.5</td> <td>0.55</td> <td>0.3</td> <td>0.55</td> </tr> <tr> <td>DLP31S</td> <td>1.0</td> <td>0.6</td> <td>0.7</td> <td>2.1</td> </tr> <tr> <td>DLM11G</td> <td>0.5</td> <td>0.5</td> <td>0.4</td> <td>0.7</td> </tr> </tbody> </table> <div style="display: flex; justify-content: space-around; margin-top: 10px;"> <div data-bbox="357 1402 533 1615"> <p>DLP2AD/31D</p> </div> <div data-bbox="635 1451 911 1592"> <table border="1"> <thead> <tr> <th>Series</th> <th>a</th> <th>b</th> <th>c</th> <th>d</th> </tr> </thead> <tbody> <tr> <td>DLP1ND</td> <td>0.3</td> <td>0.3</td> <td>0.2</td> <td>0.4</td> </tr> <tr> <td>DLP2AD</td> <td>0.55</td> <td>0.4</td> <td>0.25</td> <td>0.5</td> </tr> <tr> <td>DLP31D</td> <td>1.0</td> <td>0.8</td> <td>0.4</td> <td>0.8</td> </tr> </tbody> </table> </div> </div> <div style="display: flex; justify-content: space-around; margin-top: 10px;"> <div data-bbox="360 1630 619 1877"> <p>DLW5AH/5BS/5BT</p> </div> <div data-bbox="676 1630 895 1839"> <p>DLM2HG</p> </div> </div>	Series	a	b	c	d	DLP0NS	0.3	0.3	0.3	0.5	DLP11S	0.7	0.55	0.3	0.55	DLP11T	0.5	0.55	0.3	0.55	DLP31S	1.0	0.6	0.7	2.1	DLM11G	0.5	0.5	0.4	0.7	Series	a	b	c	d	DLP1ND	0.3	0.3	0.2	0.4	DLP2AD	0.55	0.4	0.25	0.5	DLP31D	1.0	0.8	0.4	0.8	<p>■ DLP31S/DLM2HG/DLP31D Apply 0.3mg of bonding agent at each chip.</p> <div style="display: flex; justify-content: space-around;"> <div data-bbox="986 725 1177 1032"> <p>DLP31D</p> <p>Coating Position of Bonding Agent</p> </div> <div data-bbox="1267 725 1442 987"> <p>DLP31S</p> <p>Coating Position of Bonding Agent</p> </div> </div> <div style="display: flex; justify-content: center; margin-top: 10px;"> <div data-bbox="1018 1032 1442 1205"> <p>DLM2HG</p> <p>Coating Position of Bonding Agent</p> </div> </div>
Series	a	b	c	d																																																
DLP0NS	0.3	0.3	0.3	0.5																																																
DLP11S	0.7	0.55	0.3	0.55																																																
DLP11T	0.5	0.55	0.3	0.55																																																
DLP31S	1.0	0.6	0.7	2.1																																																
DLM11G	0.5	0.5	0.4	0.7																																																
Series	a	b	c	d																																																
DLP1ND	0.3	0.3	0.2	0.4																																																
DLP2AD	0.55	0.4	0.25	0.5																																																
DLP31D	1.0	0.8	0.4	0.8																																																

△Note • Please read rating and △CAUTION (for storage, operating, rating, soldering, mounting and handling) in this catalog to prevent smoking and/or burning, etc.
 • This catalog has only typical specifications because there is no space for detailed specifications. Therefore, please review our product specifications or consult the approval sheet for product specifications before ordering.

3. Standard Soldering Conditions

(1) Soldering Methods

Use flow and reflow soldering methods only.
 Use standard soldering conditions when soldering chip common mode choke coils.
 In cases where several different parts are soldered, each having different soldering conditions, use those conditions requiring the least heat and minimum time.

Solder: Use Sn-3.0Ag-0.5Cu solder. Use of Sn-Zn based solder will deteriorate performance of products.
 If using DLP/DLM series with Sn-Zn based solder, please contact Murata in advance.

Flux:

- Use Rosin-based flux.
 In case of DLW21/31 series, use Rosin-based flux with converting chlorine content of 0.06 to 0.1wt%.
 In case of using RA type solder, products should be cleaned completely with no residual flux.
- Do not use strong acidic flux (with chlorine content exceeding 0.20wt%)
- Do not use water-soluble flux.

For additional mounting methods, please contact Murata.

(2) Soldering Profile

● **Flow Soldering Profile**
 (Sn-3.0Ag-0.5Cu Solder)

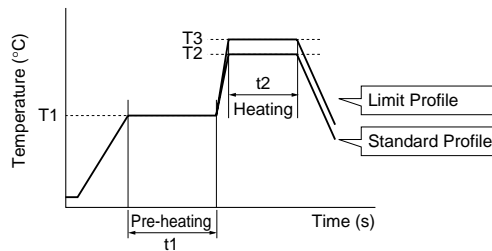

Series	Pre-heating		Standard Profile			Limit Profile		
	Temp. (T1)	Time. (t1)	Heating		Cycle of Flow	Heating		Cycle of Flow
			Temp. (T2)	Time. (t2)		Temp. (T3)	Time. (t2)	
DLM2HG DLP31D/31S	150°C	60s min.	250°C	4 to 6s	2 times max.	265±3°C	5s max.	2 times max.

● **Reflow Soldering Profile**
 (Sn-3.0Ag-0.5Cu Solder)

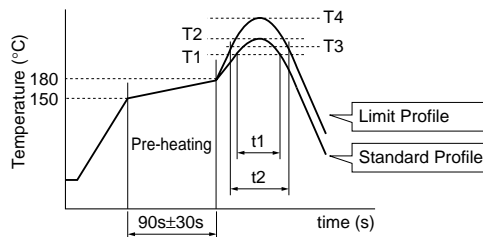

Series	Standard Profile				Limit Profile			
	Heating		Peak Temperature (T2)	Cycle of Reflow	Heating		Peak Temperature (T4)	Cycle of Reflow
	Temp. (T1)	Time. (t1)			Temp. (T3)	Time. (t2)		
DLM/DLP DLW21/31	220°C min.	30 to 60s	245±3°C	2 times max.	230°C min.	60s max.	260°C/10s	2 times max.
DLW5A/5B	220°C min.	30 to 60s	250±3°C	2 times max.	230°C min.	60s max.	260°C/10s	2 times max.

△Note • Please read rating and △CAUTION (for storage, operating, rating, soldering, mounting and handling) in this catalog to prevent smoking and/or burning, etc.
 • This catalog has only typical specifications because there is no space for detailed specifications. Therefore, please review our product specifications or consult the approval sheet for product specifications before ordering.

(3) Reworking with Solder Iron

The following conditions must be strictly followed when using a soldering iron.

Pre-heating: 150°C 60s min.

Soldering iron power output / Tip diameter:

30W max. / ø3mm max.

Temperature of soldering iron tip / Soldering time / Times:

350°C max. / 3-4s / 2 times*¹

*¹ DLP0NS, DLP11S, DLP11T, DLP1ND, DLP2AD:

380°C max. / 3-4s / 2 times

Do not allow the tip of the soldering iron to directly contact the chip.

For additional methods of reworking with a soldering iron, please contact Murata engineering.

4. Cleaning

Following conditions should be observed when cleaning chip EMI filter.

(1) Cleaning Temperature: 60°C max. (40°C max. for alcohol type cleaner)

(2) Ultrasonic

Output: 20W/liter max.

Duration: 5 minutes max.

Frequency: 28 to 40kHz

(3) Cleaning agent

The following list of cleaning agents have been tested on the individual components. Evaluation of final assembly should be completed prior to production.

Do not clean DLW (except DLW21H) series.

Before cleaning, please contact Murata engineering.

(a) Alcohol cleaning agent

Isopropyl alcohol (IPA)

(b) Aqueous cleaning agent

Pine Alpha ST-100S

(4) Ensure that flux residue is completely removed.

Component should be thoroughly dried after aqueous agent has been removed with deionized water.

1. Standard Land Pattern Dimensions

(in mm)

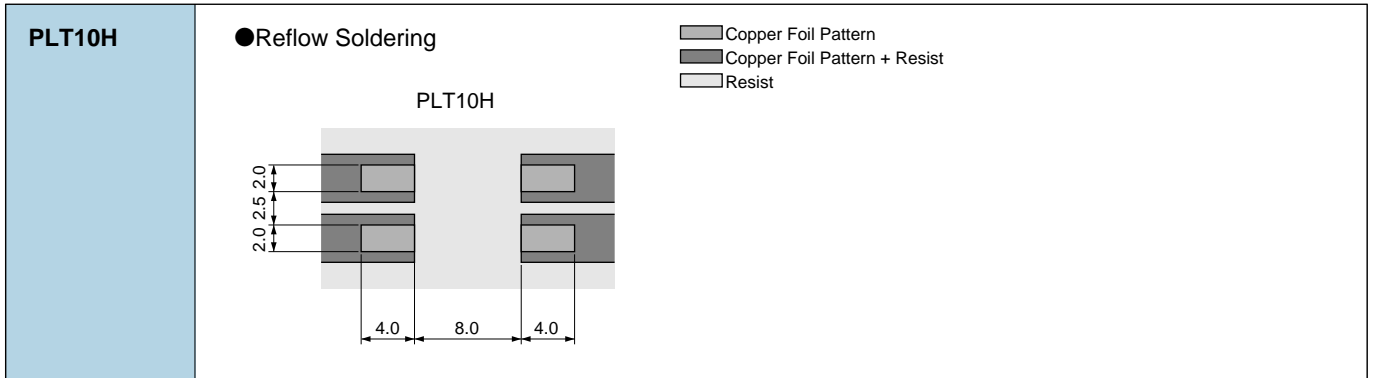

● PCB Warping

PCB should be designed so that products are not subjected to the mechanical stress caused by warping the board.

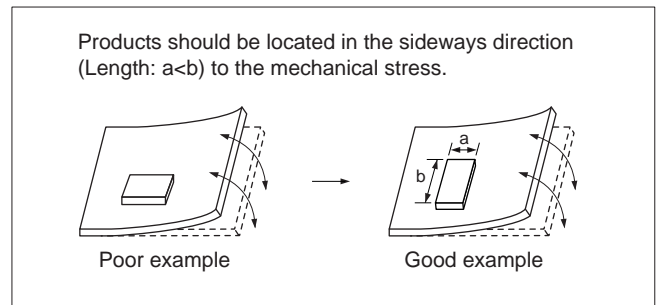

2. Solder Paste Printing and Adhesive Application

When reflow soldering the chip common mode choke coils, the printing must be conducted in accordance with the following cream solder printing conditions. If too much solder is applied, the chip will be prone to damage by mechanical and thermal stress from the PCB and may crack. Standard land dimensions should be used for resist and copper foil patterns.

When flow soldering the chip common mode choke coils, apply the adhesive in accordance with the following conditions. If too much adhesive is applied, then it may overflow into the land or termination areas and yield poor solderability. In contrast, if insufficient adhesive is applied, or if the adhesive is not sufficiently hardened, then the chip may become detached during flow soldering process.

Series	Solder Paste Printing
PLT10H	<p>● Guideline of solder paste thickness: 150-200μm: PLT10H For the solder paste printing pattern, use standard land dimensions.</p> <p>*Solderability is subject to reflow conditions and thermal conductivity. Please make sure that your product has been evaluated in view of your specifications with our product being mounted to your product.</p>

△Note • Please read rating and △CAUTION (for storage, operating, rating, soldering, mounting and handling) in this catalog to prevent smoking and/or burning, etc.
• This catalog has only typical specifications because there is no space for detailed specifications. Therefore, please review our product specifications or consult the approval sheet for product specifications before ordering.

3. Standard Soldering Conditions

(1) Soldering Methods

Use reflow soldering methods only.
 Use standard soldering conditions when soldering chip common mode choke coils.
 In cases where several different parts are soldered, each having different soldering conditions, use those conditions requiring the least heat and minimum time.

Solder: Use Sn-3.0Ag-0.5Cu solder. Use of Sn-Zn based solder will deteriorate performance of products.

Flux:

- Use Rosin-based flux.
use Rosin-based flux.
- Do not use strong acidic flux (with chlorine content exceeding 0.20wt%)
- Do not use water-soluble flux.

For additional mounting methods, please contact Murata.

(2) Soldering Profile

● Reflow Soldering Profile
 (Sn-3.0Ag-0.5Cu Solder)

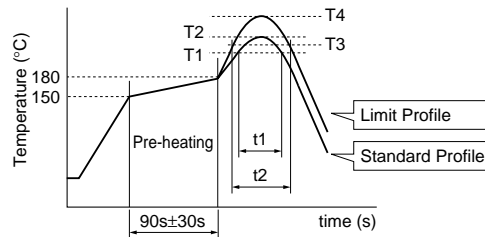

Series	Standard Profile				Limit Profile			
	Heating		Peak Temperature (T2)	Cycle of Reflow	Heating		Peak Temperature (T4)	Cycle of Reflow
	Temp. (T1)	Time. (t1)			Temp. (T3)	Time. (t2)		
PLT10H	220°C min.	30 to 60s	250±3°C	2 times max.	230°C min.	60s max.	260°C/10s	2 times max.

(3) Reworking with Solder Iron

The following conditions must be strictly followed when using a soldering iron.
 Pre-heating: 150°C 60s min.
 Soldering iron power output / Tip diameter:
 80W max. / ø3mm max.
 Temperature of soldering iron tip / Soldering time / Times:
 400°C max. / 5s / 2 times

Do not allow the tip of the soldering iron to directly contact the chip.
 For additional methods of reworking with a soldering iron, please contact Murata engineering.

4. Cleaning

Do not clean after soldering. If cleaning, please contact us.

△Note • Please read rating and △CAUTION (for storage, operating, rating, soldering, mounting and handling) in this catalog to prevent smoking and/or burning, etc.
 • This catalog has only typical specifications because there is no space for detailed specifications. Therefore, please review our product specifications or consult the approval sheet for product specifications before ordering.

DL Chip Common Mode Choke Coil Packaging

■ Minimum Quantity and Dimensions of 8mm Width Paper / Embossed Tape

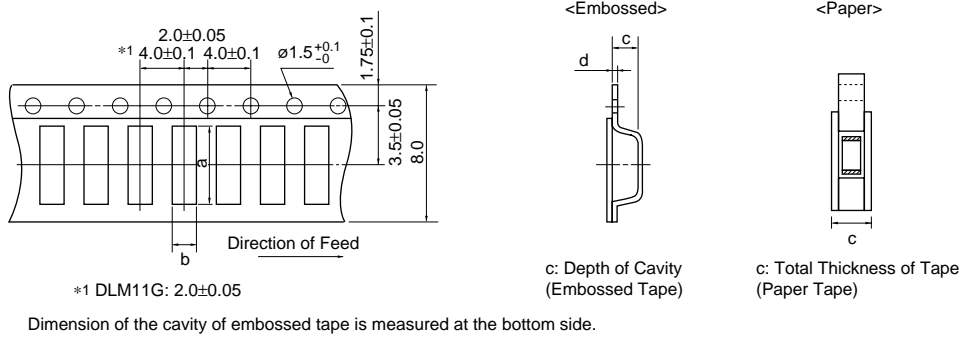

Part Number	Cavity Size				Minimum Qty. (pcs.)				Bulk
					ø180mm Reel		ø330mm Reel		
	a	b	c	d	Paper Tape	Embossed Tape	Paper Tape	Embossed Tape	
DLM11G	1.45	1.2	0.8 max.	-	10000	-	-	-	1000
DLM2HG	2.75	2.25	1.3	0.25	-	3000	-	-	1000
DLP0NS	0.95	0.75	0.55	0.25	-	5000	-	-	500
DLP11S	1.4	1.2	0.98	0.25	-	3000	-	-	500
DLP11T	1.35	1.1	0.45	0.25	-	5000	-	-	500
DLP1ND	1.7	0.84	0.57	0.25	-	5000	-	-	500
DLP2AD	2.2	1.2	0.98	0.25	-	3000	-	-	500
DLP31D/31S	3.5	1.9	1.3	0.25	-	3000	-	-	500
DLW21S	2.25	1.45	1.4	0.3	-	2000	-	-	500
DLW21H	2.3	1.55	1.1	0.25	-	3000	-	-	500
DLW31S	3.6	2.0	2.1	0.3	-	2000	-	-	500

(in mm)

■ Minimum Quantity and Dimensions of 12mm Width Embossed Tape

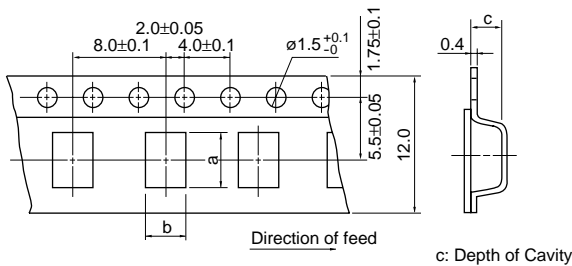

Dimension of the cavity is measured at the bottom side.

Part Number	Cavity Size			Minimum Qty. (pcs.)		
	a	b	c	ø180mm Reel	ø330mm Reel	Bulk
DLW5AH	5.4	4.1	4.4	400	1500	100
DLW5BS	5.5	5.4	4.7	400	1500	100
DLW5BT	5.5	5.4	2.7	700	2500	100

(in mm)

"Minimum Quantity" means the number of units of each delivery or order. The quantity should be an integral multiple of the "Minimum Quantity".

△Note • Please read rating and △CAUTION (for storage, operating, rating, soldering, mounting and handling) in this catalog to prevent smoking and/or burning, etc.
• This catalog has only typical specifications because there is no space for detailed specifications. Therefore, please review our product specifications or consult the approval sheet for product specifications before ordering.

C31E.pdf
Mar.28,2011

■ Minimum Quantity and Dimensions of 24mm Width Embossed Tape

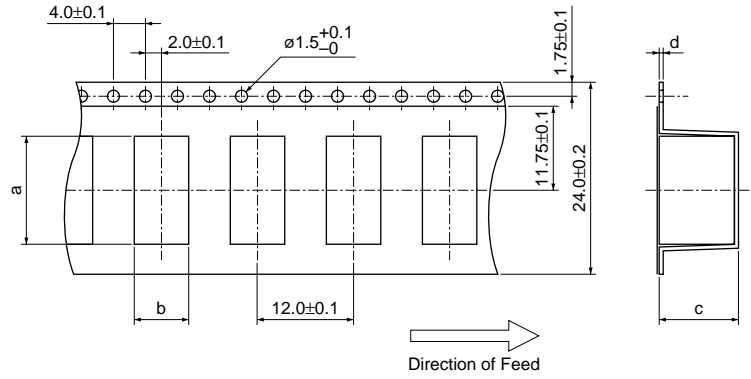

Dimension of the cavity is measured at the bottom side. (in mm)

Part Number	Cavity Size (mm)				Minimum Qty. (pcs.)		
	a	b	c	d	ø178mm Reel	ø330mm Reel	Bulk
PLT10H	13.5	6.5	9.4	0.5	125	500	50

△Note • Please read rating and △CAUTION (for storage, operating, rating, soldering, mounting and handling) in this catalog to prevent smoking and/or burning, etc.
 • This catalog has only typical specifications because there is no space for detailed specifications. Therefore, please review our product specifications or consult the approval sheet for product specifications before ordering.



●EKEMDL21L (Chip Common Mode Choke Coils)

No.	Part Number	Quantity (pcs.)	Common Mode Impedance (at 100MHz, 20 degrees C)	Rated Voltage (Vdc)	Rated Current (mA)
1	DLW21HN670SQ2	10	67Ω±25%	50	330
2	DLW21HN900SQ2	10	90Ω±25%	50	330
3	DLW21HN121SQ2	10	120Ω±25%	50	280
4	DLW21HN181SQ2	10	180Ω±25%	50	250
5	DLW21SN670SQ2	10	67Ω±25%	50	400
6	DLW21SN900SQ2	10	90Ω±25%	50	330
7	DLW21SN121SQ2	10	120Ω±25%	50	370
8	DLW21SN181SQ2	10	180Ω±25%	50	330
9	DLW21SN261SQ2	10	260Ω±25%	50	300
10	DLW21SN371SQ2	10	370Ω±25%	50	280
11	DLW21SN670HQ2	10	67Ω±25%	20	320
12	DLW21SN900HQ2	10	90Ω±25%	20	280
13	DLW21SN121HQ2	10	120Ω±25%	20	280
14	DLW21SR670HQ2	10	67Ω±25%	20	400
15	DLP0NSA150HL2	10	15Ω±5Ω	5	100
16	DLP0NSC280HL2	10	28Ω±20%	5	100
17	DLP0NSN670HL2	10	67Ω±20%	5	110
18	DLP0NSN900HL2	10	90Ω±20%	5	100
19	DLP0NSN121HL2	10	120Ω±20%	5	90
20	DLP1NDN350HL4	10	35Ω±20%	5	100
21	DLP1NDN670HL4	10	67Ω±20%	5	80
22	DLP1NDN900HL4	10	90Ω±20%	5	60
23	DLP11SA350HL2	10	35Ω±20%	5	170
24	DLP11SA670HL2	10	67Ω±20%	5	150
25	DLP11SA900HL2	10	90Ω±20%	5	150
26	DLP11SN670SL2	10	67Ω±20%	5	180
27	DLP11SN121SL2	10	120Ω±20%	5	140
28	DLP11SN161SL2	10	160Ω±20%	5	120
29	DLP11SN900HL2	10	90Ω±20%	5	150
30	DLP11SN201HL2	10	200Ω±20%	5	110
31	DLP11SN241HL2	10	240Ω±20%	5	100
32	DLP11SN281HL2	10	280Ω±20%	5	90
33	DLP11SN331HL2	10	330Ω±20%	5	80
34	DLP11TB800UL2	10	80Ω±25%	5	100
35	DLP2ADA350HL4	10	35Ω±20%	5	150
36	DLP2ADA670HL4	10	67Ω±20%	5	130
37	DLP2ADA900HL4	10	90Ω±20%	5	120
38	DLP2ADN670HL4	10	67Ω±20%	5	140
39	DLP2ADN900HL4	10	90Ω±20%	5	130
40	DLP2ADN121HL4	10	120Ω±20%	5	120
41	DLP2ADN161HL4	10	160Ω±20%	5	100
42	DLP2ADN201HL4	10	200Ω±20%	5	90
43	DLP2ADN241HL4	10	240Ω±20%	5	80
44	DLP2ADN281HL4	10	280Ω±20%	5	80

△Note • Please read rating and △CAUTION (for storage, operating, rating, soldering, mounting and handling) in this catalog to prevent smoking and/or burning, etc.
 • This catalog has only typical specifications because there is no space for detailed specifications. Therefore, please review our product specifications or consult the approval sheet for product specifications before ordering.

●EKEMDCC5C (Chip Common Mode Choke Coils for DC Power Line / SMD Block type EMIFIL[®] for Power Line)

No.	Part Number	Quantity (pcs.)	Common Mode Impedance (at 100MHz, 20 degrees C)	Rated Voltage (Vdc)	Rated Current (mA)
1	DLW5AHN402SQ2	5	4000Ω (Typ.)	50	200
2	DLW5BSN191SQ2	5	190Ω (Typ.)	50	5000
3	DLW5BSN351SQ2	5	350Ω (Typ.)	50	2000
4	DLW5BSN102SQ2	5	1000Ω (Typ.)	50	1500
5	DLW5BSN152SQ2	5	1500Ω (Typ.)	50	1000
6	DLW5BSN302SQ2	5	3000Ω (Typ.)	50	500
7	DLW5BTN101SQ2	5	100Ω (Typ.)	50	6000
8	DLW5BTN251SQ2	5	250Ω (Typ.)	50	5000
9	DLW5BTN501SQ2	5	500Ω (Typ.)	50	4000
10	DLW5BTN102SQ2	5	1000Ω (Typ.)	50	2000
11	DLW5BTN142SQ2	5	1400Ω (Typ.)	50	1500

△Note • Please read rating and △CAUTION (for storage, operating, rating, soldering, mounting and handling) in this catalog to prevent smoking and/or burning, etc.
 • This catalog has only typical specifications because there is no space for detailed specifications. Therefore, please review our product specifications or consult the approval sheet for product specifications before ordering.

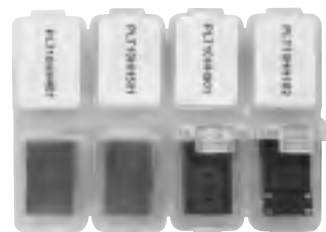

●EKEPPL10B (Common Mode Choke Coil)

No.	Part Number	Quantity (pcs.)	Common Mode Impedance (at 10MHz, 20 degrees C)	Rated Voltage (Vdc)	Rated Current (A)
1	PLT10HH401100PN	6	400Ω (Typ.)	100	10
2	PLT10HH501100PN	6	500Ω (Typ.)	100	10
3	PLT10HH9016R0PN	6	900Ω (Typ.)	100	6
4	PLT10HH1026R0PN	6	1000Ω (Typ.)	100	6

△Note • Please read rating and △CAUTION (for storage, operating, rating, soldering, mounting and handling) in this catalog to prevent smoking and/or burning, etc.
 • This catalog has only typical specifications because there is no space for detailed specifications. Therefore, please review our product specifications or consult the approval sheet for product specifications before ordering.