

General Information

	Page
General Product Information	574 - 576
Technical notes	577 - 580
Selection diagram	581

Sub-miniature Fuses

Chip 0402, 0603, 0805, 1206	582 - 585
2.6 x 6.1 mm (SMD)	586 - 587
4.5 x 8 mm (SMD)	588 - 589
4.5 x 16 mm (SMD)	590 - 591
8.4 x 7.6mm	592 - 596
2.3 x 8 mm	597

G-Fuse Links

5 x 20 mm	598 - 613
10x 51 mm	614
5 x 25 mm	615 - 617
5 x L mm	618
5 x 30 mm	619
6.3 x 32 mm	620 - 629
8 x 40 mm	630
8 x 50 mm / 8 x 85 mm 8	631
x 120 mm / 8 x 150 mm	632

G-Fuse Holders and Fuse Bases

633 - 643

RoHS

General Product Information

Article Number	Page	RoHS	Dimensions [mm]	Rated Voltage	Characteristics	Rated Breaking Current	Standard or Description
151000	582	◆	1.00 x 0.5	32V _{DC}	FF	50A	UL 248-14
152000	583	◆	1.55 x 0.85	32V _{DC}	FF	50A	UL 248-14, IEC 60127- 4
153000	584	◆	2.00 x 1.25	32V _{DC}	FF	50A	UL 248-14, IEC 60127- 4
154000	585	◆	3.20 x 1.6	63V _{DC}	FF	50A	UL 248-14, IEC 60127- 4
157000	586	◆	2.60 x 6.1	125V _{AC/DC}	F	50A _{AC/DC}	UL 248-14, CSA C22.s No 248.14
158000	587	◆		125V _{AC/DC}	T	50A _{AC/DC}	UL 248-14, CSA C22.s No 248.14
160000	588	◆	4.5 x 8.0	250V _{AC}	T	100A	IEC 60127
161000	589	◆	4.5 x 8.0	250V _{AC}	F	100A	IEC 60127-4
160016	590	◆	4.5 x 16	305V _{AC}	T	1.5kA	UL 248-14, IEC 60127-4/2
163016	591	◆	4.5 x 16	250V _{AC}	TT	135A	IEC 60127-4
164000	592	◆	8.4 x 7.6	250V _{AC}	F	(35A / 10xI _{Rat})	IEC 60127-3/3, EN 60127-3/3, VDE 0820-3/3
164050							
164500	593	◆	8.4 x 7.6	250V _{AC}	F	50A	UL 248-14, CSA C22.s No 248.14
164550							
165000	594	◆	8.4 x 7.6	250V _{AC}	M	(35A / 10xI _{Rat})	IEC 60127-3
165050							
166000	595	◆	8.4 x 7.6	250V _{AC}	T	(35A / 10xI _{Rat})	IEC 60127-3/4, EN 60127-3/4, VDE 0820-3/4
166050							
166500	596	◆	8.4 x 7.6	250V _{AC}	T	50A	UL 248-14, CSA C22.s No 248.14
166550							
196000	597	◆	2.3 x 8	125V _{AC/DC}	F	300A _{DC} /50A _{AC}	UL 248-14
70 001 40	598	◆	5 x 20	250V _{AC}	FF	300kA/1.5kA	Special Type
70 007 40	599	◆	5 x 20	400V _{AC}	FF	10kA/300kA	Special Type
70 180 40	600	◆	5 x 20	660V _{AC}	aR(FF)	100kA _{AC/DC}	Special Type
179020	601	◆	5 x 20	250V _{AC}	F	(35A / 10xI _{Rat})	IEC 60127-2/2, EN 60127-2/2, VDE 0820-2/2
179021	602	◆	5 x 20	250V _{AC}	F	1.5kA/1kA	IEC 60127-2/1, EN 60127-2/1, VDE 0820-2/1
171100	603	◆	5 x 20	250V _{AC}	F	1kA/300A	DIN 41571-1
172000	604	◆	5 x 20	250V _{AC}	M	80A	DIN 41571-2
172100		1kA/300A					
172200	605	◆	5 x 20	250V _{AC}	M	1.5kA	DIN 41571-2
179120	606	◆	5 x 20	250V _{AC}	T	(35A / 10xI _{Rat})	IEC 60127-2/3, EN 60127-2/3, VDE 0820-2/3
179150	607	◆	5 x 20	250V _{AC}	T	150A	IEC 60127-2/6, EN 60127-2/6, VDE 0820-2/6
179200	608	◆	5 x 20	250V _{AC} /300V _{DC}	T	1.5kA _{AC/DC}	IEC 60127-2/6, EN 60127-2/6, VDE 0820-2/6
179200SMD	609	◆	5 x 20	250V _{AC}	T	1.5kA	IEC 60127-2/5, EN 60127-2/5, VDE 0820-2/5
173100	610	◆	5 x 20	250V _{AC}	T	300A	DIN 41571-3
179500	611	◆	5 x 20	250V _{AC}	T/D	35A/100A	UL 248-14, CSA C22.s No 248.14
190000	612	◆	5 x 20	250V _{AC}	TT	(35A / 10xI _{Rat})	Special Type
171525	613	◆	5 x 25	250V _{AC}	F	50A/80A	Special Type
172525		M					
7001908	614	◆	10 x 51	60V _{AC}		1.5kA	DIN 41572
171526	615	◆	5 x 25	250V _{AC}	F	1.5kA	DIN 41576-1
172526	616	◆	5 x 25	250V _{AC}	M	80A/1.5kA	DIN 41576-2
7008913	617	◆	5 x 25	450V _{AC} /250V _{DC}	F	70kA _{AC} /10kA _{DC}	Lloyds Approved
7001607	618	◆	5 x 25	250V _{AC}	M	80A/1.5kA	DIN 41577T,2
7001707		◆	5 x 25				
7001407		◆	5 x 20				
7001205		◆	5 x 20				

SIBA LLC

Phone 1-973-575-7422
Fax 1-973-575-5858

29 Fairfield Place
West Caldwell, New Jersey 07006

e-mail: info@sibafuse.com
www.siba-fuses.us

G



General Product Information

171530	619		5 x 30	500V _{AC}	F	50A/80A	Special Type
172530					M		
7012540	620		6.3 x 32	700V _{AC} /500V _{AC}	FF	80A/1.5kA	Special Type
7017240	621		6.3 x 32	1000V _{AC/DC}	aR(FF)	30kA _{AC/DC}	Short circuit protection only
7006584	622		6.3 x 32	400V _{AC}	gRL	120kA	IEC 60269-4, VDE 0636 Tail 4
189000	623		6.3 x 32	250V _{AC}	F	(35A / 10xI _{Rat})	IEC 60269-2/4
189020	624		6.3 x 32	500V _{AC} /440V _{DC}	F	50kA/1.5kA	Special Type
7009463	625		6.3 x 32	600V _{AC}	F	50kA	Special Type
189100	626		6.3 x 32	250V _{AC}	T	(35A / 10xI _{Rat})	Special Type
189140	627		6.3 x 32	500V _{AC} - 250V _{AC}	T	1.5kA/10kA	Special Type
189500	628		6.3 x 32	250V _{AC} /125V _{AC}	T/D	100A/10kA	
7006526	629		6.3 x 32	400V _{DC}	gPV	30kA	Following IEC 60269-4
183000	630		8 x 40	500V _{AC}	F	80A/1.5kA	DIN 41686
184000			8 x 50	1.2kV _{AC}	M	35A	DIN 41570
7103401	631		8 x 50	1.2kV _{AC}			Fuse Base
185000			8 x 85	3kV _{AC}	F	35A	DIN 41569
7103701			8 x 85	3kV _{AC}			Fuse Base
186000	632		8 x 120	6kV _{AC}	M/F	35A	DIN 41683
7104001			8 x 120	6kV _{AC}			Fuse Base
187000			8 x 150	10kV _{AC}		35A	DIN 41684
7104301			8 x 150	10kV _{AC}			Fuse Base
7011509	633		10 x 85	3kV _{AC}	F		Company
7011527			10 x 85	1.5kV _{AC} /1kV _{DC}	T		Company
7011552			10 x 85	1.5kV _{AC} /1kV _{DC}	F		Company
7012927			11 x 79	1kV _{AC}	T		Company
7012952			11 x 79	1kV _{AC}	F		Company
7017182			10 x 85	1kV _{AC}	aM		Company
7002924			12 x 100	3kV _{AC}	F		Company
7002927			12 x 100	3kV _{AC}	T		Company
7003024			12 x 150	6kV _{AC}	F		Company
7003124			12 x 200	10kV _{AC}	F		Company
7103702			633		10 x 85	3kV _{AC}	
7102901	633		12 x 100	3kV _{AC}			Fuse Base, 6.3A, 4W
7103001			12 x 150	6kV _{AC}			Fuse Base, 4A 4W
7103101			12 x 200	10kV _{AC}			Fuse Base, 2A 4W
166602	634		8.4 x 7.6	250V _{AC}			Fuse base PCB for 8.4 x7.6 subminiature fuse, 6.3A
199073	634		Ø 5mm				Fuse Clips PCB for Ø 5mm, 6.3A
199207							
199487							
199429			Ø 6.3mm				Fuse Clips PCB for Ø 6.3mm, 10A
199011	634		5 x 20	250V _{AC} /300V _{DC}			Fuse base SMD, 6.3A
199012							Fuse base cover
199015	635		5 x 20	250V _{AC}			Fuse base PCB, 6.3A
199015A							Fuse base cover
199016							
199018	635		5 x 20	250V _{AC}			Fuse base PCB, 6.3a
199019							Fuse base cover
199060	635		5 x 20	250V _{AC}			Fuse base PCB, 6.3a

SIBA LLC

Phone 1-973-575-7422

29 Fairfield Place

Fax 1-973-575-5858

West Caldwell, New Jersey 07006

e-mail: info@sibafuse.com

www.siba-fuses.us



General Product Information

199030	636		5 x 20	250V _{AC}	6.3A	Fuse holder panel mount, screw cap, 2.8mm plug or solder
199035			5 x 20	250V _{AC}	6.3A	Fuse holder panel mount, screw cap, 2.8mm plug or solder
199040			5 x 20	250V _{AC}	6.3A	Fuse holder panel mount, screw cap, 2.8mm plug or solder
199045			5 x 20	250V _{AC}	6.3A	Fuse holder PCB vertical, bayonet cap
199050			5 x 20	250V _{AC}	6.3A	Fuse holder PCB horizontal, bayonet cap
199055	637		5 x 20	250V _{AC}	6.3A	Fuse holder panel mount, bayonet cap, solder
199070			5 x 20	250V _{AC}	6.3A	Fuse holder panel mount, bayonet cap, 4.8mm plug or solder
199090	638		5 x 20	250V _{AC}	6.3A VDE/10A UL	Fuse holder panel mount, bayonet cap, solder
199080			5x20/6.3x32	250V _{AC}	6.3A	Fuse holder inline
199511	639		5x20/6.3x32	250V _{AC}	10A VDE/16A UL	Fuse base SMD
199537			5x20/6.3x32	500V _{AC} /250V _{AC}	10A VDE/16A UL	Fuse base PCB
199530	640		6.3x32	500V _{AC} /250V _{AC}	10A VDE/20A UL	Fuse holder panel mount, w/o cap, 6.3mm plug or solder
199531			6.3x32	500V _{AC} /250V _{AC}	16A VDE/30A UL	Fuse carrier bayonet cap
199550	641		6.3x32	500V _{AC} /250V _{AC}	16A VDE/30A UL	Fuse holder PCB mount, w/o cap
199552			6.3x32	500V _{AC} /250V _{AC}	16A VDE/30A UL	Fuse carrier screw cap for fuse holder
199555	642		6.3x32	500V _{AC} /250V _{AC}	16A VDE/30A UL	Fuse holder panel mount, w/o cap, 6.3mm plug
199552			6.3x32	500V _{AC} /250V _{AC}	16A VDE/30A UL	Fuse carrier screw cap for fuse holder
7100127	643		6.3x32	250V _{AC}	10A VDE/16A UL	Fuse holder PCB mount horizontal w/ bayonet carrier
7100128			6.3x32	250V _{AC}	10A VDE/16A UL	Fuse holder PCB mount vertical w/ bayonet carrier
7100129	644		6.3x32	250V _{AC}	10A VDE/16A UL	Fuse holder panel mount w/ bayonet carrier, solder
199052			6.3x32	250V _{AC}	10A VDE/16A UL	Fuse holder panel mount w/ screw carrier, solder
204000	645		Ø 5mm		6.3A max	Press on lead end cap PCB, lead Ø 0.65mm
204001					10A max	Press on lead end cap PCB, lead Ø 0.8mm
204002					16A max	Press on lead end cap PCB, lead Ø 1.0mm
204100					12.5A max	Press on lead end cap PCB, lead Ø 0.8mm
204101	646		Ø 6.3mm		20A max	Press on lead end cap PCB, lead Ø 1.0mm
199022			6.3x32		250V _{AC}	10A max
7100114	647		5x20/6.3x32	250V _{AC}	10A VDE/16A UL	Fuse holder PCB horizontal mount w/ bayonet
7100116			5x20/6.3x32	250V _{AC}	10A VDE/16A UL	Fuse holder PCB vertical mount w/o bayonet
7100123			5x20/6.3x32	250V _{AC}	10A VDE/10A UL	Fuse holder panel mount w/ out carrier, solder
7100124			5x20/6.3x32	250V _{AC}	10A VDE/20A UL	Fuse holder panel mount w/o bayonet carrier, solder
7200108		648		5x20		
7200109			6.3x32			Fuse carrier bayonet for 6.3x32

Technical Notes

1 Introduction

Miniature fuses are automatic switchgears that protect electrical plants, appliances and modules from inadmissibly high current loads. They have various applications. Miniature fuses are used in consumer electronics for safeguarding power supplies and power output amplifiers. They are often used in industrial applications as primary fuses, where in the event of a fault they separate the defective module from the voltage supply in order to forestall any greater damage. Fuse-links for direct mounting on printed circuit boards are used among other things for the secondary current supply in low power devices. In the event of a fault they serve to protect components and PCB traces that might be destroyed by excessive current loads.

2 Designs

The traditional miniature fuse is cylindrical in shape, with a diameter of 5mm and a length of 20mm. There is also a design used internationally which has the dimensions 6.3 x 32mm. Depending on their rating, these fuses, whose characteristic might be very quick acting to long time-lag, can switch off short circuit currents of up to several kiloamperes at mains voltages of up to 1 000 V.

Sub-miniature fuses (KS) are used for through hole assembly on printed circuit boards. Whether their characteristic is quick acting or time-lag, these fuses with a rated voltage of 250 V are used in primary circuits for protecting mains transformers and in secondary circuits for selective protection of the modules.

SMD fuses at rated voltages of up to 250 V are available for surface mounting on printed circuit boards. Their applications are similar to those of the sub-miniature fuses (KS) described above. As regards their breaking performance, they are also designed with the special requirements of the telecom industry in mind.

3 Terminology

Miniature fuses consist of the fuse-link and the fuse holder. The fuse link contains the fuse-element and must, after the latter has melted, be replaced by a new fuse-link. The fuse-element can continuously carry the rated current under given conditions. When the rated current has been exceeded, the fuse-element melts above a value prescribed by the standards, and the electrical circuit is broken. The duration of the melting process is prescribed in the relevant standards.

The fuse-link is inserted into a fuse-holder. The latter consists of the fuse base (mount) and the (screw or bayonet) fuse carrier. The fuse base is firmly mounted in the device to be protected and provides the electrical connection. The fuse carrier receives the fuse link, allowing easy replacement. Open fuse holders and clips are often used besides such 'enclosed' fuse holders.

3.1 Rated voltage (nominal voltage) U_{rat}

The rated voltage of a fuse link is given as the r.m.s. value of a sinusoidal alternating voltage at 50 Hz. All the test conditions are laid down in accordance with it. The voltage U_b driving the short circuit current must not be greater than the rated voltage.

$$U_{rat} \geq U_b$$

Operation at direct voltage is possible if the rated voltage is reduced; we will be glad to advise you on this matter if you provide us with the maximum fault current and the time constants of the fault current circuit.

3.2 Rated Current I_{rat}

The rated current given is the r.m.s. value. Under prescribed conditions, the fuse-link can operate permanently at the rated current level. Ambient conditions, cyclic currents and special assembly conditions can lead to a de-rating of the rated current. The I_b operating current must not be greater than the rated current during normal operation.

$$I_{rat} \geq I_b$$

3.3 Rated Breaking Capacity I_1 at U_{rat}

The rated breaking capacity characterizes the maximum current I_1 that the fuse-link can properly switch off at the rated voltage. In certain applications it may be necessary to reduce the expected short-circuit current by means of additional impedances in the electrical circuit.

$$I_1 \geq I_p$$

3.4 Voltage Drop ΔU

The voltage drop is determined with the fuse-link in operation at its rated current and at an ambient temperature of 23 °C.

3.5 Pre-arcing integral I^2t_s

The pre-arcing integral is calculated by integrating the square of the current over the pre-arcing time. The value indicates the electrical load that leads to the melting of the fuse-element. The value for the pre-arcing integral is determined at a test current of 10 I_r and is as a typical value.

3.6 Operating integral I^2t_A

The operating integral is calculated by integrating the square of the current over the total operating time of the fuse link. The value is a measure of the load on the downstream components during breaking operation of the fuse link in the event of a short circuit.

3.7 Power dissipation P_v

The Power dissipation of a fuse link is calculated by multiplying the conventional nonfusing current I_{nf} by the voltage drop ΔU determined at this load after an hour.

4 Structure of miniature Fuse-Links

4.1 The glass tube

If the maximum expected short circuit current (prospective current I_p) is not greater than 35 A or max. 10 I_{rat}, then a miniature fuse link with an unfilled glass tube is used. This fuse-link has the advantage of a relatively low voltage drop.

4.2 The reinforced glass tube

Miniature fuse-links with reinforced unfilled glass tubes can switch off prospective currents of up to 150 A at the rated voltage.

4.3 The filled glass tube

Prospective currents of up to 1 000 A can be switched off at the rated voltage by a combination of quartz sand filling as extinguish filler and reinforcement of the glass tube.

4.4 The filled ceramic tube

A further increase in the rated breaking capacity up to a prospective current of several kA is achieved by the use of ceramic tube filled with quartz sand.

4.5 The terminal caps

A copper alloy is usually used as working material for the terminal caps. The caps are plated by means of a special surface treatment to provide better electrical and thermal contact, as well as for protection against corrosion.

5 Characteristics

The characteristic is an expression for the time-current performance of the fuse-links.

FF	Very quick acting	Short circuit protection for semiconductor components (diodes, thyristors, triacs, transistors, MCT, etc.)
gRL	Very quick acting	Full range protection of semiconductors and their supply lines
gPV		For protection of photovoltaic systems
F	Quick acting	Protection against high overload and short circuit currents, fuses are used in electrical circuit without inrush current pulse, or as mains fuses
M	Medium time lag	Used primarily at low operating voltages, if no high inrush currents have to be taken into account.
T	Time lag	For high inrush currents have slow decaying transients(e.g. transformers).
TT	Long time lag	For very high and long lasting inrush currents(e.g. motors)

6 Standards

Besides several specific national standards, the principal standard applied worldwide is IEC 60127. It is divided into one general part, parts dealing with the individual fuse designs, one part for fuse holders, one specification for quality confirmation as well as one user's manual. The German-language equivalent of this International Standard is VDE 0820.

In the North American countries, the reference standard for miniature fuses is UL 248. Special care is required in converting the rated currents of IEC 60127 into those according to UL 248 (see figure 1).

7 Applications

7.1 Different definitions of the Rated Currents in the International Standards

In principle, two different ratings of the continuous current must be taken into account, preventing direct conversion of the fuse links according to IEC 60127 and UL 248-14.

- a) Continuous current rating according to IEC 60127

$$I_{rat} \geq I_b$$

- b) Continuous current rating according to UL 248-14

$$I_{rat} \geq I_b / 0,7$$

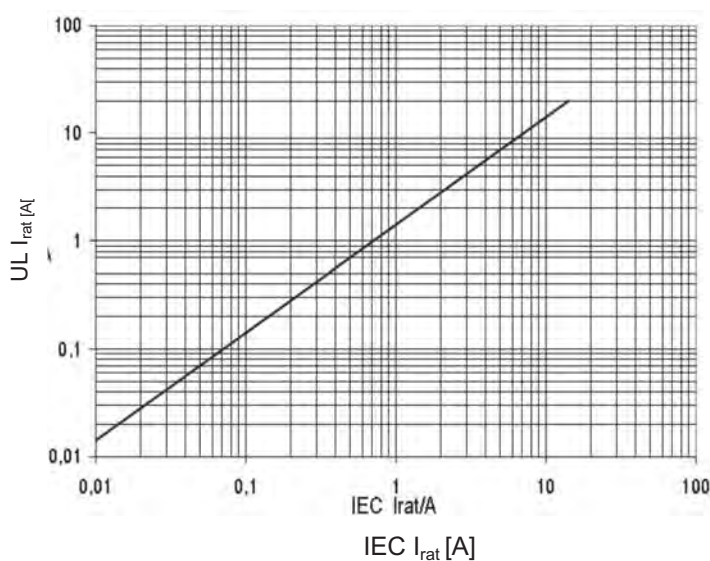

Figure 1

Figure 1 enables approximate conversion of rated current between UL and IEC standards

7.2 Operation at extra-Low-Voltage $U_b \ll U_{rat}$

Fuse-links can operate without difficulty at voltages below their rated voltage. The voltage drop of the fuse-links (internal resistance) must be taken into consideration, particularly at very low rated currents.

7.3 Operation at raised ambient temperatures

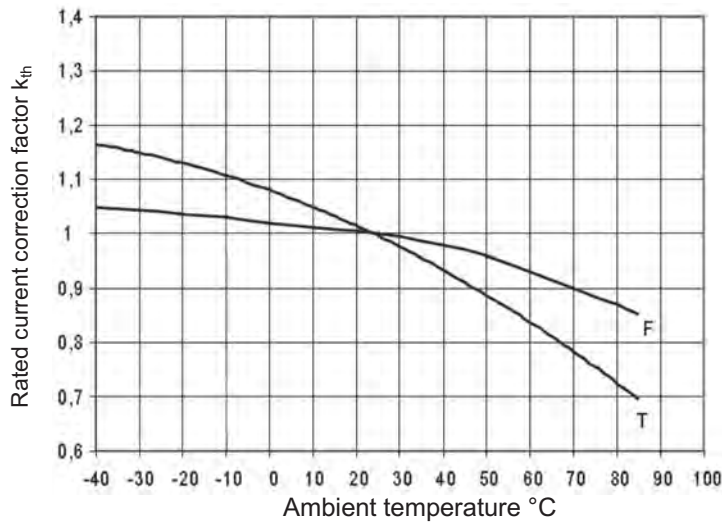

The shift in the rated current at various ambient temperatures can be determined with reference to Figure 2.

Figure 2

7.4 Pulse loads

If pulse loads arise in an electrical circuit to be protected, then that must be taken into consideration when assigning a fuse link, particularly the latter's pre-arcing integral I^2t s. Reduction factors can be provided on the basis of extensive series of in house tests relating to pulse amplitude, pulse duration and frequency of occurrence.

7.5 Protection of semiconductor components

When protecting power electronics components, the I^2t value of the fuse-link is adjusted to the energy pulse (or I^2t value) of the component to be protected.

7.6 Power acceptance of the miniature Fuse Holder

The maximum power acceptance of the fuse holder must not be exceeded by the Power dissipation of the fuse link selected. Contact resistances and assembly conditions shall additionally be taken into account here.

8 Safety through Quality

In order to ensure compliance with the quality requirements, SIBA practices the documented quality management system (QM system) on the basis of the International Standard DIN EN ISO 9001. The environmental management system according to DIN EN ISO 14001 regulates the planning, implementation and supervision of environmental protection in the company.

9 Selection diagram

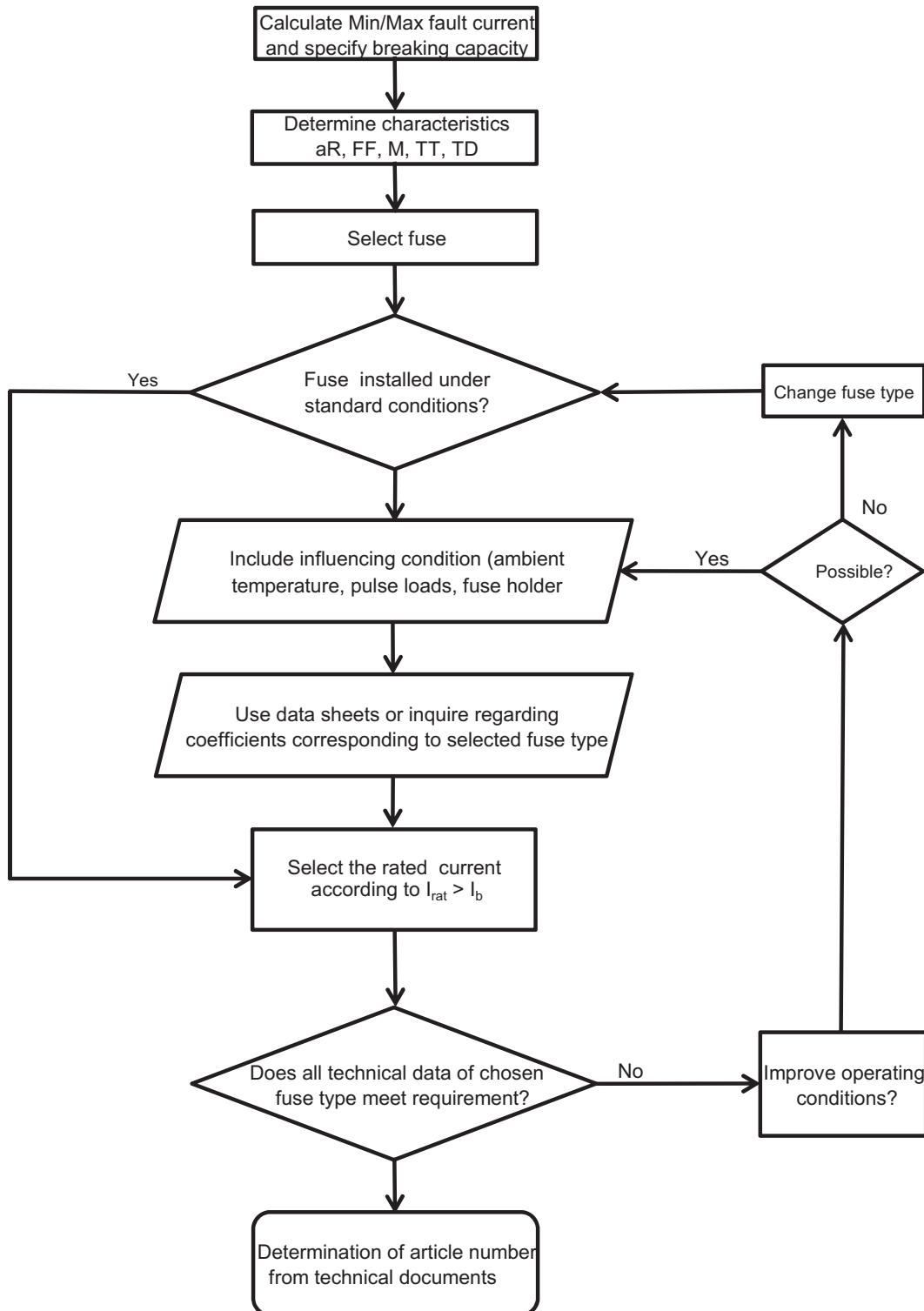

G



E167295



Rated Voltage

[Un]

32V_{DC}

Rated Breaking Test

Voltage

32V_{DC}

Capacity

50A

Class

FF



Standard(s)

UL 248-14

IEC 60068-2-6

IEC 60127-4

042(1mmx0.5mm) - Ceramic Substrate -Printed Element

Rated Current I_n [A]	Article Number	UL rec	Rated Breaking Current [A]	Voltage Drop [mV]	Cold Resistance [mΩ]	Pre-arcing I^2t @ 10 I_n [A ² s]	Approvals	Marking
0.500	151000.0.500	✓	50A @ 32V _{DC}	420	640	0.0009		
0.630	151000.0.630	✓	50A @ 32V _{DC}	331	400	0.0014		
0.750	151000.0.750	✓	50A @ 32V _{DC}	275	280	0.0020		
0.800	151000.0.800	✓	50A @ 32V _{DC}	231	220	0.0023		
1	151000.1	✓	50A @ 32V _{DC}	184	140	0.0028		
1.25	151000.1.25	✓	50A @ 32V _{DC}	159	97	0.0039		
1.5	151000.1.5	✓	50A @ 32V _{DC}	146	74	0.0059		
1.6	151000.1.6	✓	50A @ 32V _{DC}	136	65	0.0065		
1.75	151000.1.75	✓	50A @ 32V _{DC}	124	54	0.0077		
2	151000.2	✓	50A @ 32V _{DC}	115	44	0.0101		
2.5	151000.2.5		50A @ 32V _{DC}	107	33	0.0157		
3	151000.3		50A @ 32V _{DC}	95	24	0.0227		
3.15	151000.3.15		50A @ 32V _{DC}	90	22	0.0250		

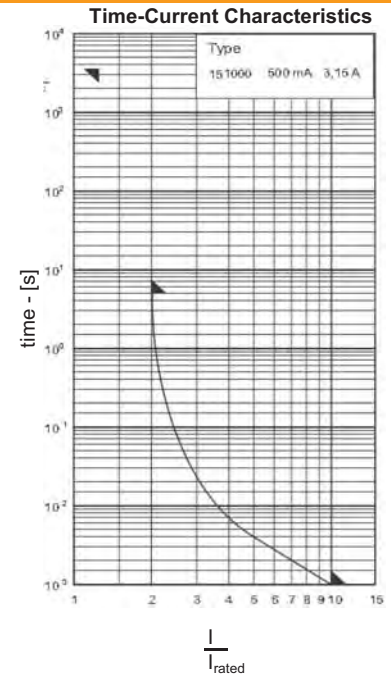

Tape reel ordering, add following suffix to article number

GT-1k (1 000 pieces on tape reel)

GT-5k (5 000 pieces on tape reel)

GT-10k (10 000 pieces on tape reel)

e.g. 151000.0.750GT-5k

Rated Current	Fusing Time Limits										
	1.25 I_n		2 I_n		2.75 I_n		4 I_n		10 I_n		
	Min	Max	Min	Max	Min	Max	Min	Max	Min	Max	
500mA - 3A	1h	—	—	1s	—	—	—	—	—	—	1ms

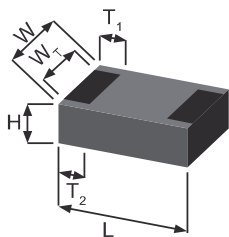

Dimensions [mm]	
H	0.32 ± 0.05
L	1.0 ± 0.05
W	0.5 ± 0.05
W _T	> 75% of W
T ₁	0.2+0.1/-0.15
T ₂	0.2 ± 0.1

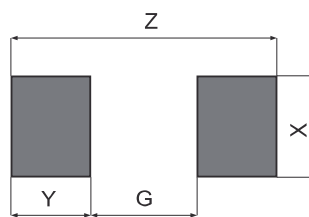

Reflow	Solder Pad Dimensions [mm]	wave
0.25	G	
0.55	X	
0.6	Y	
1.45	Z	





Resistance to soldering heat, 260°C, 10s, solder bath
(to IEC 60068-2 -58) 260°C, 10s, reflow

Vibration IEC - 60068-2-6

Insulation resistance - IEC 60127-4

GSS  **Rated Voltage** [Un] **Rated Breaking Test** **Class** **Standard(s)**

 **RoHS** **32V_{DC}** **Voltage** **Capacity** **FF** **UL 248-14**

E167295  **50A** **50A**  **IEC 60068-2-6**

063(1.55mmx0.85mm) - Ceramic Substrate -Printed Element **IEC 60127-4**

Rated Current I_n [A]	Article Number	UL rec	Rated Breaking Current [A]	Voltage Drop [mV]	Cold Resistance [mΩ]	Pre-arcing I^2t @ 10I _n [A ² s]	Approvals V - VDE	Marking
0.500	152000.0.500	✓	50A @ 32V _{DC} ¹	361	550	0.0009	V	F
0.630	152000.0.630	✓	50A @ 32V _{DC}	331	400	0.0014		CT
0.750	152000.0.750	✓	50A @ 32V _{DC}	258	262	0.0020		G
0.800	152000.0.800	✓	50A @ 32V _{DC}	249	237	0.0023		CV
1	152000.1	✓	50A @ 32V _{DC} ¹	223	170	0.0028	V	H
1.25	152000.1.25	✓	50A @ 32V _{DC}	180	110	0.0039		J
1.5	152000.1.5	✓	50A @ 32V _{DC}	155	79	0.0059		K
1.6	152000.1.6	✓	50A @ 32V _{DC} ¹	159	76	0.0065	V	EF
1.75	152000.1.75	✓	50A @ 32V _{DC}	138	60	0.0077		L
2	152000.2	✓	50A @ 32V _{DC} ¹	150	57	0.0101	V	N
2.5	152000.2.5	✓	50A @ 32V _{DC}	151	37	0.0157		O
3	152000.3	✓	50A @ 32V _{DC}	126	32	0.0227		P
3.15	152000.3.15	✓	50A @ 32V _{DC} ¹	120	29	0.0250	V	EL
3.5	152000.3.5	✓	50A @ 32V _{DC}	106	23	0.0308		R
4	152000.4	✓	50A @ 32V _{DC}	100	19	0.0403		S
5	152000.5		50A @ 32V _{DC}	85	13	0.228		T

¹⁾ 50A @ 50V_{DC} with VDE approval

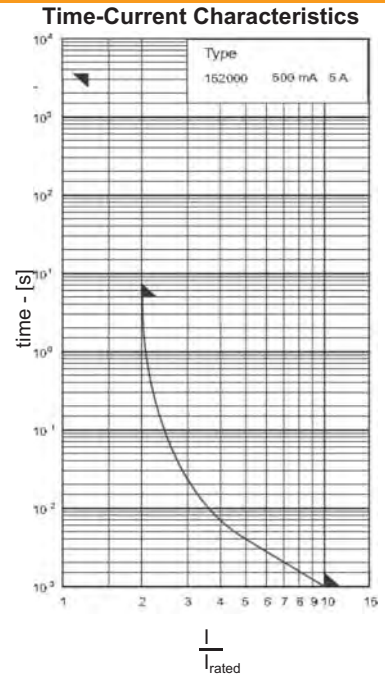

Tape reel ordering, add following suffix to article number

- GT-1k (1 000 pieces on tape reel)
- GT-5k (5 000 pieces on tape reel)
- GT-20k (20 000 pieces on tape reel)
- e.g. 152000.3.15GT-5k

Rated Current	Fusing Time Limits										
	1.25I _n		2I _n		2.75I _n		4I _n		10I _n		
	Min	Max	Min	Max	Min	Max	Min	Max	Min	Max	
500mA - 3A	1h	—	—	5s	—	—	—	—	—	—	1ms

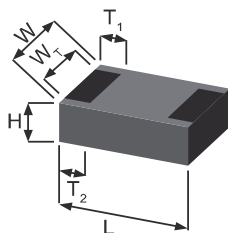

Dimensions	[mm]
H	0.45+01/-0.05
L	1.55 ± 0.05
W	0.85 ± 0.1
W _T	> 75% of W
T ₁	0.3+0.15/-0.2
T ₂	0.3+0.15/-0.2

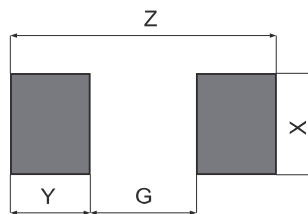

Reflow	Solder Pad Dimensions [mm]	wave
0.5	G	0.5
0.95	X	1.1
0.95	Y	1.2
2.4	Z	2.9



Resistance to soldering heat, 260°C, 10s, solder bath
(to IEC 60068-2 -58) 260°C, 10s, reflow

Vibration IEC - 60068-2-6

Insulation resistance - IEC 60127-4

G



E167295



Rated Voltage

[Un]
32V_{DC}

Rated Breaking Test

Voltage Capacity
32V_{DC} 50A

Class

FF



Standard(s)

UL 248-14
IEC 60068-2-6
IEC 60127-4

085(2mmx1.25mm) - Ceramic Substrate -Printed Element

Rated Current I_n [A]	Article Number	UL rec	Rated Breaking Current [A]	Voltage Drop [mV]	Cold Resistance [mΩ]	Pre-arcing I^2t @ 10I _n [A ² s]	Approvals	Marking
0.500	153000.0.500	✓	50A @ 32V _{DC}	374	570	0.0009		F
0.630	153000.0.630	✓	50A @ 32V _{DC}	347	420	0.0014		CT
0.750	153000.0.750	✓	50A @ 32V _{DC}	280	285	0.0020		G
0.800	153000.0.800	✓	50A @ 32V _{DC}	262	250	0.0023		CV
1	153000.1	✓	50A @ 32V _{DC}	243	185	0.0028		H
1.25	153000.1.25	✓	50A @ 32V _{DC}	205	125	0.0039		J
1.5	153000.1.5	✓	50A @ 32V _{DC}	171	87	0.0059		K
1.6	153000.1.6	✓	50A @ 32V _{DC}	164	78	0.0065		EF
1.75	153000.1.75	✓	50A @ 32V _{DC}	161	70	0.0077		L
2	153000.2	✓	50A @ 32V _{DC}	176	67	0.0101		N
2.5	153000.2.5	✓	50A @ 32V _{DC}	131	40	0.0157		O
3	153000.3	✓	50A @ 32V _{DC}	134	34	0.0227		P
3.15	153000.3.15	✓	50A @ 32V _{DC}	128	31	0.0250		EL
3.5	153000.3.5	✓	50A @ 32V _{DC}	119	26	0.0308		R
4	153000.4	✓	50A @ 32V _{DC}	105	20	0.0403		S
5	153000.5		50A @ 32V _{DC}	98	15	0.228		T

Time-Current Characteristics

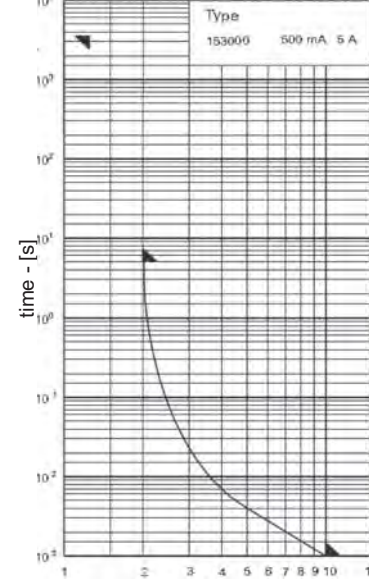

Tape reel ordering, add following suffix to article number

GT-1k (1 000 pieces on tape reel)

GT-5k (5 000 pieces on tape reel)

GT-20k (20 000 pieces on tape reel)

e.g. 153000.1.750GT-5k

$$\frac{I}{I_{rated}}$$

Rated Current	Fusing Time Limits									
	1.25I _n		2I _n		2.75I _n		4I _n		10I _n	
	Min	Max	Min	Max	Min	Max	Min	Max	Min	Max
500mA - 3A	1h	—	—	5s	—	—	—	—	—	1ms

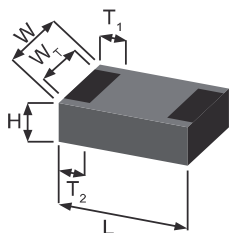

Dimensions [mm]	Value
H	0.45+0.1/-0.05
L	2.0 ± 0.1
W	1.25 ± 0.15
W _T	> 75% of W
T ₁	0.4+0.1/-0.2
T ₂	0.4+0.1/-0.2

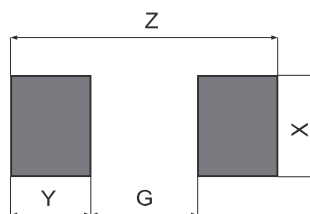

Reflow	Solder Pad Dimensions [mm]	wave
0.65	G	0.65
1.4	X	1.5
1.1	Y	1.4
2.85	Z	3.45

Resistance to soldering heat, 260°C, 10s, solder bath
(to IEC 60068-2 -58) 260°C, 10s, reflow

Vibration IEC - 60068-2-6

Insulation resistance - IEC 60127-4

G **RoHS** **Rated Voltage** [Un] **32V_{DC}** **Rated Breaking Test** Voltage **32V_{DC}** Capacity **50A** **Class** **FF** **Standard(s)** **UL 248-14** **IEC 60068-2-6** **IEC 60127-4**

E167295 **1206(3.2mmx1.6mm) - Ceramic Substrate -Printed Element**

Rated Current I _n [A]	Article Number	UL rec	Rated Breaking Current [A]	Voltage Drop [mV]	Cold Resistance [mΩ]	Pre-arcing I ² t @ 10I _n [A ² s]	Approvals V - VDE	Marking
0.250	154000.0.250	*	1	310	880	0.0001		
0.375	154000.0.375	*	1	260	470	0.0004		
0.500	154000.0.500	✓	50A @ 63V _{DC} ²	433	660	0.0009	V	F
0.630	154000.0.630	✓	50A @ 63V _{DC}	372	450	0.0014		CT
0.750	154000.0.750	✓	50A @ 63V _{DC}	325	330	0.0022		G
0.800	154000.0.800	✓	50A @ 63V _{DC}	273	260	0.0023		CV
1	154000.1	✓	50A @ 63V _{DC} ²	262	200	0.0028	V	H
1.25	154000.1.25	✓	50A @ 63V _{DC}	230	140	0.0041		J
1.5	154000.1.5	✓	50A @ 63V _{DC}	207	105	0.0059		K
1.6	154000.1.6	✓	50A @ 63V _{DC} ²	168	80	0.0066	V	EF
1.75	154000.1.75	✓	50A @ 63V _{DC}	174	76	0.0077		L
2	154000.2	✓	50A @ 63V _{DC} ²	181	69	0.0102	V	N
2.5	154000.2.5	✓	50A @ 63V _{DC}	161	49	0.0159		O
3	154000.3	✓	50A @ 63V _{DC}	173	44	0.0229		P
3.15	154000.3.15	✓	50A @ 63V _{DC} ²	153	37	0.0251	V	EL
3.5	154000.3.5	✓	50A @ 63V _{DC}	161	35	0.0310		R
4	154000.4	✓	50A @ 63V _{DC}	147	28	0.0404		S
5	152000.5		50A @ 63V _{DC}	131	20	0.228		T
6.3	154000.6.3		50A @ 63V _{DC}	116	14	0.516		ET

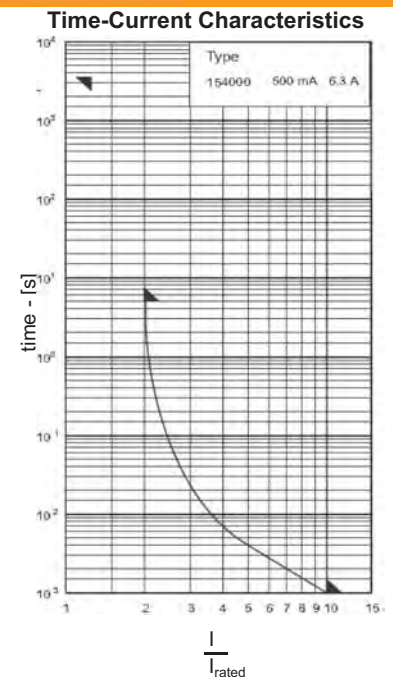

* UL listed ¹⁾ 50A @ 63V_{DC}, 100A @ 125V_{AC} ²⁾ 50A @ 50V_{DC} with VDE approval

Tape reel ordering, add following suffix to article number

- GT-1k (1 000 pieces on tape reel)
- GT-5k (5 000 pieces on tape reel)
- GT-20k (20 000 pieces on tape reel)
- e.g. 154000.6.3GT-5k

Rated Current	Fusing Time Limits									
	1I _n		1.25I _n		2I _n		3I _n		10I _n	
	Min	Max	Min	Max	Min	Max	Min	Max	Min	Max
250mA - 375mA	1h	—	—	—	—	5s	—	200ms	—	—
500mA - 5A	1h	—	—	—	—	5s	—	—	—	1ms

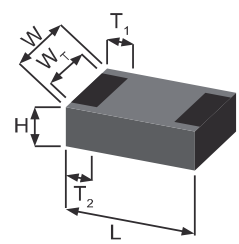

	Dimensions [mm]
H	0.55 ± 0.1
L	3.2+0.1/-0.2
W	1.6 ± 0.15
W _T	> 75% of W
T ₁	0.5 ± 0.25
T ₂	0.3 ± 0.25

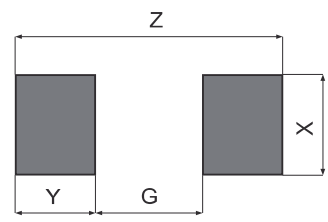

Reflow	Solder Pad Dimensions [mm]	wave
1.5	G	1.5
1.75	X	1.9
1.25	Y	1.6
4.0	Z	4.7

Resistance to soldering heat, 260°C, 10s, solder bath (to IEC 60068-2 -58) 260°C, 10s, reflow

Vibration IEC - 60068-2-6

Insulation resistance - IEC 60127-4

GSS **Rated Voltage** **Rated Breaking Test** **Class** **Standard(s)**
[Un] **Voltage** **Capacity** **F**
125/65V_{AC/DC} **125V_{AC/DC}** **50A** **UL 248-14**
65V_{AC/DC} **50A** **CSA C22.s -**
No 248.14

2.6mmx6.1mm - Ceramic Body - Contacts, Brass - Silver Plated

Rated Current I_n [A]	Article Number	UL rec	Rated Breaking Current [A]	Voltage Drop [mV]	Cold Resistance [mΩ]	Pre-arcing I^2t @ 10I _n [A ² s]	Approvals	Marking
0.062	157000.0.062	✓	50A @ 125V _{AC/DC}	600	5 500	0.00019		
0.080	157000.0.080	✓	50A @ 125V _{AC/DC}	550	4 050	0.00033		
0.100	157000.0.100	✓	50A @ 125V _{AC/DC}	350	2 000	0.0014		
0.125	157000.0.125	✓	50A @ 125V _{AC/DC}	240	1 500	0.0028		
0.160	157000.0.160	✓	50A @ 125V _{AC/DC}	350	1 400	0.0031		
0.200	157000.0.200	✓	50A @ 125V _{AC/DC}	250	800	0.0066		
0.250	157000.0.250	✓	50A @ 125V _{AC/DC}	230	600	0.011		
0.315	157000.0.315	✓	50A @ 125V _{AC/DC}	210	420	0.023		
0.375	157000.0.375	✓	50A @ 125V _{AC/DC}	180	300	0.043		
0.400	157000.0.400	✓	50A @ 125V _{AC/DC}	180	290	0.048		
0.500	157000.0.500	✓	50A @ 125V _{AC/DC}	180	230	0.073		
0.630	157000.0.630	✓	50A @ 125V _{AC/DC}	180	190	0.12		
0.750	157000.0.750	✓	50A @ 125V _{AC/DC}	170	160	0.18		
0.800	157000.0.800	✓	50A @ 125V _{AC/DC}	160	130	0.26		
1	157000.1	✓	50A @ 125V _{AC/DC}	150	100	0.45		
1.25	157000.1.25	✓	50A @ 125V _{AC/DC}	150	78	0.68		
1.5	157000.1.5	✓	50A @ 125V _{AC/DC}	150	63	0.85		
1.6	157000.1.6	✓	50A @ 125V _{AC/DC}	140	58	1.05		
2	157000.2	✓	50A @ 125V _{AC/DC}	100	37	0.57		
2.5	157000.2.5	✓	50A @ 125V _{AC/DC}	100	28	1.1		
3	157000.3	✓	50A @ 125V _{AC/DC}	100	23	1.5		
3.15	157000.3.15	✓	50A @ 125V _{AC/DC}	100	21	1.9		
3.5	157000.3.5	✓	50A @ 125V _{AC/DC}	100	19	2.5		
4	157000.4	✓	50A @ 125V _{AC/DC}	100	16	3.3		
5	157000.5	✓	50A @ 125V _{AC/DC}	90	12.5	6.2		
6.3	157000.6.3	✓	50A @ 125V _{AC/DC}	90	10	9.1		
7	157000.7	✓	50A @ 125V _{AC/DC}	90	8.6	11		
10	157000.10	✓	50A @ 125V _{AC/DC}	90	5.9	27		
12	157000.12	✓	50A @ 125V _{AC/DC}	90	4.9	45		
15	157000.15	✓	50A @ 125V _{AC/DC}	90	3.8	81		

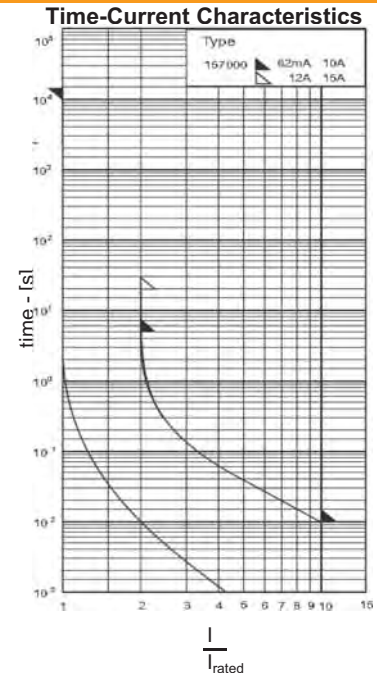

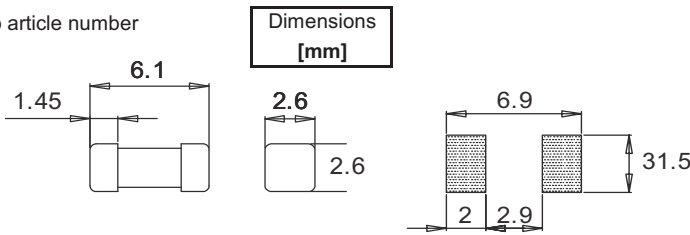

Tape reel ordering, add following suffix to article number
 GT - (1 000 pieces on tape reel)
 e.g. 157000.3.15GT



Rated Current	Fusing Time Limits									
	1I _n		2I _n		2.75I _n		4I _n		10I _n	
	Min	Max	Min	Max	Min	Max	Min	Max	Min	Max
62mA - 10A	4h	—	—	5s	—	5s	—	—	—	10ms
12A - 15A	4h	—	—	20s	—	5s	—	—	—	10ms

Resistance to soldering heat, 260°C, 10s, to IEC 60068

G   **Rated Voltage** [Un] **Rated Breaking Test** **Class** **Standard(s)**
 E167295 **125V_{AC/DC}** **125V_{AC/DC}** **50A** **T** **UL 248-14**
2.6mmx6.1mm - Ceramic Body - Contacts, Brass - Silver Plated **CSA C22.s - No 248.14**

Rated Current I_n [A]	Article Number	UL rec	Rated Breaking Current [A]	Voltage Drop [mV]	Cold Resistance [mΩ]	Pre-arcing I^2t @ $10I_n$ [A ² s]	Approvals	Marking
0.250	158000.0.250	✓	50A @ 125V _{AC/DC}	280	900	0.08		
0.315	158000.0.315	✓	50A @ 125V _{AC/DC}	260	700	0.016		
0.375	158000.0.375	✓	50A @ 125V _{AC/DC} ¹⁾	230	500	0.035		
0.400	158000.0.400	✓	50A @ 125V _{AC/DC} ¹⁾	220	450	0.035		
0.500	158000.0.500	✓	50A @ 125V _{AC/DC} ¹⁾	200	300	1.0		
0.630	158000.0.630	✓	50A @ 125V _{AC/DC} ¹⁾	200	200	1.4		
0.750	158000.0.750	✓	50A @ 125V _{AC/DC} ¹⁾	190	170	1.5		
0.800	158000.0.800	✓	50A @ 125V _{AC/DC} ¹⁾	170	140	1.5		
1	158000.1	✓	50A @ 125V _{AC/DC} ¹⁾	150	120	4.0		
1.25	158000.1.25	✓	50A @ 125V _{AC/DC} ¹⁾	150	90	4.6		
1.5	158000.1.5	✓	50A @ 125V _{AC/DC} ¹⁾	130	60	4.8		
1.6	158000.1.6	✓	50A @ 125V _{AC/DC} ¹⁾	130	55	4.8		
2	158000.2	✓	50A @ 125V _{AC/DC} ¹⁾	120	45	8.6		
2.5	158000.2.5	✓	50A @ 125V _{AC/DC} ¹⁾	120	30	16		
3	158000.3	✓	50A @ 125V _{AC/DC} ¹⁾	110	23	24		
3.15	158000.3.15	✓	50A @ 125V _{AC/DC} ¹⁾	100	20	24		
3.5	158000.3.5	✓	50A @ 125V _{AC/DC} ¹⁾	100	18	38		
4	158000.4	✓	50A @ 125V _{AC/DC} ¹⁾	100	15	44		
5	158000.5	✓	50A @ 125V _{AC/DC} ¹⁾	90	11	77		
6.3	158000.6.3	✓	50A @ 125V _{AC/DC} ¹⁾	80	8	130		
7	158000.7	✓	50A @ 125V _{AC/DC} ¹⁾	90	8	130		

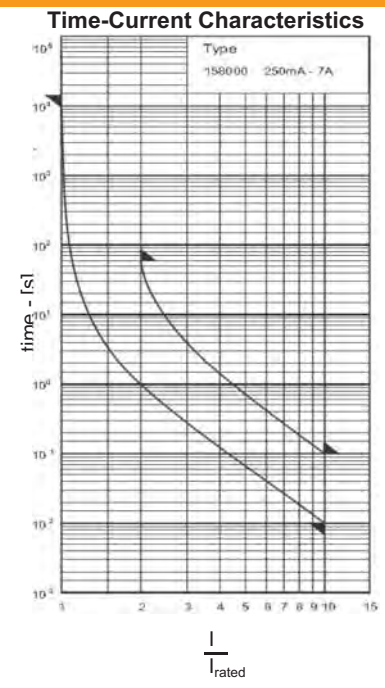

¹⁾ 50A @ 125V_{AC} and 50A with UL recognition

Tape reel ordering, add following suffix to article number
 GT - (1 000 pieces on tape reel)
 e.g. 158000.2.5GT



Dimensions [mm]

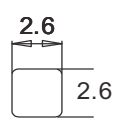
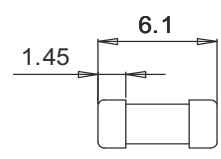

Recommended Pad Layout

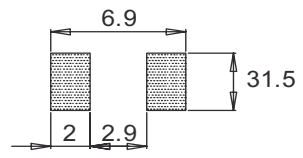

Rated Current	Fusing Time Limits									
	$1I_n$		$2I_n$		$2.75I_n$		$4I_n$		$10I_n$	
	Min	Max	Min	Max	Min	Max	Min	Max	Min	Max
250mA - 7A	4h	—	—	60s	—	5s	—	—	10ms	100ms

Resistance to soldering heat, 260°C, 10s, to IEC 60068

G



Rated Voltage

[Un]
250V_{AC}

Rated Breaking Test

Voltage Capacity
250V_{AC} 100A

Class

T

Standard(s)

IEC 60127

4.5mmx8mm - Ceramic Tube- Contacts, Brass - Silver Plated

Rated Current I_n [A]	Article Number	UL rec	Rated Breaking Current [A]	Voltage Drop [mV]	Power Dissipation @ 1.5 I_n [mW]	Pre-arcing I^2t @ 10 I_n [A ² s]	Approvals	Marking
0.032	160000.0.032	✓	100A @ 250V _{AC}	1 150	125	0.014		
0.040	160000.0.040	✓	100A @ 250V _{AC}	860	150	0.013		
0.050	160000.0.050	✓	100A @ 250V _{AC}	800	155	0.013		
0.063	160000.0.063	✓	100A @ 250V _{AC}	580	160	0.020		
0.080	160000.0.080	✓	100A @ 250V _{AC}	480	150	0.035		
0.100	160000.0.100	✓	100A @ 250V _{AC}	350	155	0.06		
0.125	160000.0.125	✓	100A @ 250V _{AC}	300	160	0.12		
0.160	160000.0.160	✓	100A @ 250V _{AC}	280	190	0.21		
0.200	160000.0.200	✓	100A @ 250V _{AC}	260	200	0.32		
0.250	160000.0.250	✓	100A @ 250V _{AC}	240	220	0.5		
0.315	160000.0.315	✓	100A @ 250V _{AC}	220	250	0.8		
0.400	160000.0.400	✓	100A @ 250V _{AC}	200	280	1.1		
0.500	160000.0.500	✓	100A @ 250V _{AC}	190	310	1.8		
0.630	160000.0.630	✓	100A @ 250V _{AC}	180	360	3.2		
0.800	160000.0.800	✓	100A @ 250V _{AC}	160	430	5.2		
1	160000.1	✓	100A @ 250V _{AC}	140	500	6.8		
1.25	160000.1.25	✓	100A @ 250V _{AC}	130	600	12		
1.6	160000.1.6	✓	100A @ 250V _{AC}	120	730	22		
2	160000.2	✓	100A @ 250V _{AC}	100	870	30		
2.5	160000.2.5	✓	100A @ 250V _{AC}	100	1 000	46		
3.15	160000.3.15	✓	100A @ 250V _{AC}	100	1 200	80		
4	160000.4	✓	100A @ 250V _{AC}	100	1 400	130		
5	160000.5	✓	100A @ 250V _{AC}	100	1 700	130		

IEC 32mA - 250mA, 100A @ 125V_{DC}

IEC 315mA - 5A, 100A @ 60V_{DC}

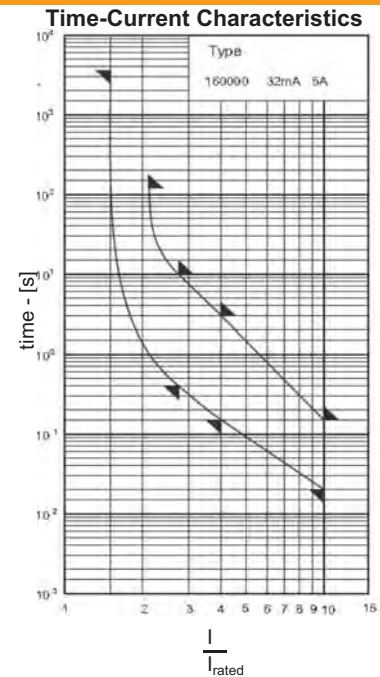

Tape reel ordering, add following suffix to article number

GT - (500 pieces on tape reel)

e.g. 160000.0.5GT

Dimensions
[mm]

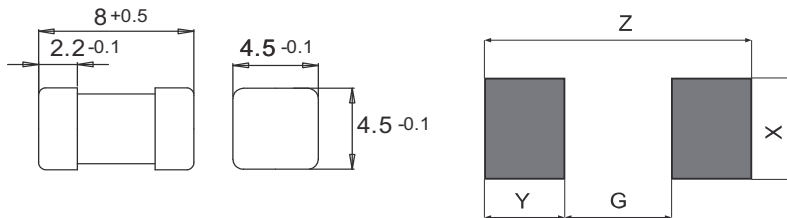

Reflow	Solder Pad Dimensions [mm]	wave
3.6	G	3.6
5.6	X	6.8
2.7	Y	4.2
9.0	Z	12.0



Rated Current	Fusing Time Limits									
	1 I_n		2 I_n		2.75 I_n		4 I_n		10 I_n	
	Min	Max	Min	Max	Min	Max	Min	Max	Min	Max
32mA - 5A	1h	—	—	2m	400ms	10ms	150ms	3s	20ms	150ms

Resistance to soldering heat, 260°C, 10s, solder bath
(to IEC 60068-2 -58)

G RoHS **Rated Voltage** $[U_n]$ **Rated Breaking Test** **Class** **Standard(s)**

$250V_{AC}$ **Voltage** **Capacity** **F** **IEC 60127-4**

$250V_{AC}$ $100A$

4.5mmx8mm - Ceramic Tube w/Filler Contacts- Brass - Silver Plated



Rated Current I_n [A]	Article Number	Rated Breaking Current [A]	Voltage Drop [mV]	Power Dissipation @ $1.25I_n$ [mW]	Pre-arcing I^2t [A ² s]	Approvals	Marking
0.500	161000.0.500	100A @ 250V _{AC}	200	300	0.076		
0.630	161000.0.630	100A @ 250V _{AC}	180	300	0.19		
0.800	161000.0.800	100A @ 250V _{AC}	160	300	0.38		
1	161000.1	100A @ 250V _{AC}	140	300	0.71		
1.25	161000.1.25	100A @ 250V _{AC}	140	400	0.94		
1.6	161000.1.6	100A @ 250V _{AC}	120	400	0.56		
2	161000.2	100A @ 250V _{AC}	110	500	1.1		
2.5	161000.2.5	100A @ 250V _{AC}	100	600	2.0		
3.15	161000.3.15	100A @ 250V _{AC}	100	700	3.2		
4	161000.4	100A @ 250V _{AC}	100	900	5.0		
5	161000.5	100A @ 250V _{AC}	100	1 000	9.0		
6.3	161000.6.3	100A @ 250V _{AC}	100	1 400	13		

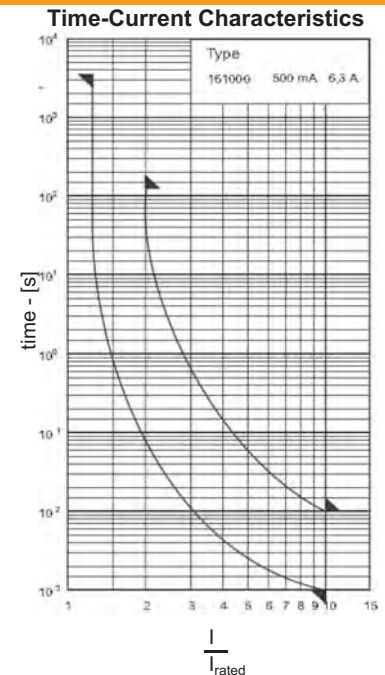

Tape reel ordering, add following suffix to article number
 GT - (500 pieces on tape reel)
 e.g. 161000.1.6GT



Dimensions [mm]

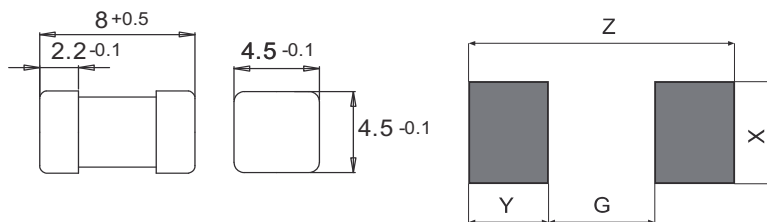

Reflow	Solder Pad Dimensions [mm]	wave
3.6	G	3.6
5.6	X	6.8
2.7	Y	4.2
9.0	Z	12.0

Rated Current	Fusing Time Limits									
	$1.25I_n$		$2I_n$		$2.75I_n$		$4I_n$		$10I_n$	
	Min	Max	Min	Max	Min	Max	Min	Max	Min	Max
500mA - 6.3A	1h	—	—	120s	—	—	—	—	1ms	0ms

Resistance to soldering heat, 260°C, 10s, solder bath (to IEC 60068-2 -58)

G **Rated Voltage** [Un] 250V_{AC} **Rated Breaking Test Voltage** 250V_{AC} **Capacity** 100A **Class** T **Standard(s)** UL 248-14 IEC 60127-4/2

4.5mmx16mm - Ceramic Tube w/filling, Contacts - Copper Alloy - Silver Plated

Rated Current I _n [A]	Article Number	UL rec	Rated Breaking Current [A]	Voltage Drop [mV]	Power Dissipation @ 1.25I _n [mW]	Pre-arcing I ² t @ 10I _n [A ² s]	Approvals S - Semko	Marking
0.050	160016.0.050	✓	Data on request					
0.080	160016.0.080	✓	1.5kA @ 305V _{AC} ¹	2 050	270	0.025	S	
0.100	160016.0.100	✓	1.5kA @ 305V _{AC} ¹	1 750	290	0.030	S	
0.125	160016.0.125	✓	1.5kA @ 305V _{AC} ¹	1 430	310	0.055	S	
0.160	160016.0.160	✓	1.5kA @ 305V _{AC} ¹	1 220	340	0.065	S	
0.200	160016.0.200	✓	1.5kA @ 305V _{AC} ¹	960	350	0.11	S	
0.250	160016.0.250	✓	1.5kA @ 305V _{AC} ¹	840	360	0.19	S	
0.315	160016.0.315	✓	1.5kA @ 305V _{AC} ¹	700	380	0.34	S	
0.400	160016.0.400	✓	1.5kA @ 305V _{AC} ¹	570	400	0.54	S	
0.500	160016.0.500	✓	1.5kA @ 305V _{AC} ¹	490	430	0.86	S	
0.630	160016.0.630	✓	1.5kA @ 305V _{AC} ¹	410	460	1.5	S	
0.800	160016.0.800	✓	1.5kA @ 305V _{AC} ¹	350	490	2.6	S	
1	160016.1	✓	1.5kA @ 305V _{AC} ¹	380	640	4.5	S	
1.25	160016.1.25	✓	1.5kA @ 305V _{AC} ¹	340	790	4.1	S	
1.6	160016.1.6	✓	1.5kA @ 305V _{AC} ¹	330	970	6.2	S	
2	160016.2	✓	1.5kA @ 305V _{AC} ¹	280	1 060	13	S	
2.5	160016.2.5	✓	1.5kA @ 305V _{AC} ¹	240	1 120	21	S	
3.15	160016.3.15	✓	1.5kA @ 305V _{AC} ¹	200	1 200	35	S	
4	160016.4	✓	1.5kA @ 305V _{AC} ¹	160	1 250	49	S	
5	160016.5	✓	1.5kA @ 277V _{AC} ¹	140	1 300	92	S	
6.3	160016.6.3	✓	1.5kA @ 277V _{AC} ¹	120	1 370	170	S	
8	160016.8	✓	1.5kA @ 250V _{AC} ¹	90	1 250	160	S	
10	160016.10	✓	1.5kA @ 250V _{AC} ¹	80	1 500	280	S	

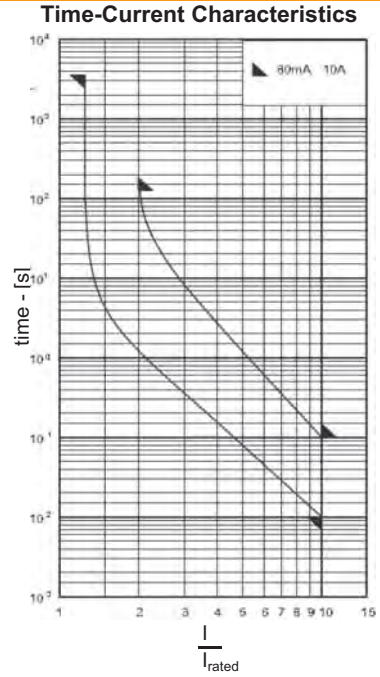

Tape reel ordering, add following suffix to article number
 GT - (1 500 pieces on tape reel)
 e.g. 160016.1.25GT

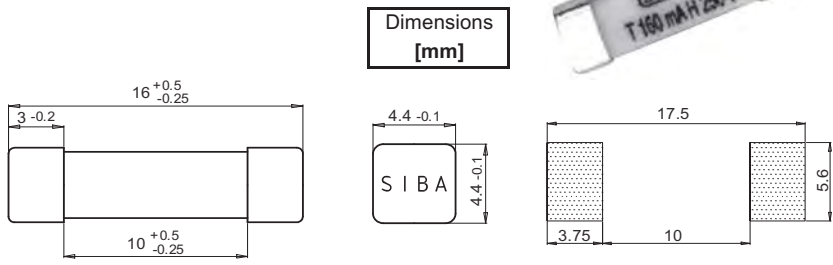

Recommended Pad Layout

Rated Current	Fusing Time Limits									
	1.25I _n		2I _n		2.75I _n		4I _n		10I _n	
	Min	Max	Min	Max	Min	Max	Min	Max	Min	Max
250mA - 7A	1h	—	2m	—	—	5s	—	—	10ms	100ms

Resistance to soldering heat, 260°C, 10s, to IEC 60068

G RoHS **Rated Voltage** $[U_n]$ **Rated Breaking Test** **Class** **Standard(s)**
 $250V_{AC}$ **Voltage** **Capacity** **TT** **IEC 60127-4**
 $250V_{AC}$ **35A**

4.5mmx16mm - Ceramic Tube w/Filler, Contacts - Copper Alloy - Silver Plated

Rated Current I_n [A]	Article Number	Rated Breaking Current [A]	Voltage Drop [mV]	Power Dissipation @ $1.5I_n$ [mW]	Pre-arcing I^2t @ $10I_n$ [A ² s]	Approvals	Marking
0.160	163016.0.160	35A @ 250V _{AC}	*	*	*		
0.200	163016.0.200	35A @ 250V _{AC}	*	*	*		
0.250	163016.0.250	35A @ 250V _{AC}	*	*	*		
0.315	163016.0.315	35A @ 250V _{AC}	*	*	*		
0.400	163016.0.400	35A @ 250V _{AC}	190	190	4.5		
0.500	163016.0.500	35A @ 250V _{AC}	*	*	*		
0.630	163016.0.630	35A @ 250V _{AC}	*	*	*		
0.800	163016.0.800	35A @ 250V _{AC}	160	350	14		
1	163016.1	35A @ 250V _{AC}	160	550	23		
2	163016.2	35A @ 250V _{AC}	80	500	80		
2.5	163016.2.5	35A @ 250V _{AC}	*	*	*		

* Data on request

Tape reel ordering, add following suffix to article number

GT - (1 500 pieces on tape reel)

e.g. 163016.1.25GT

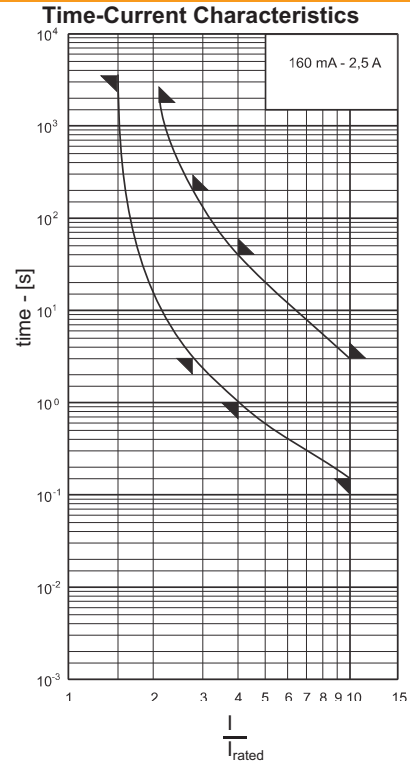

Dimensions [mm]

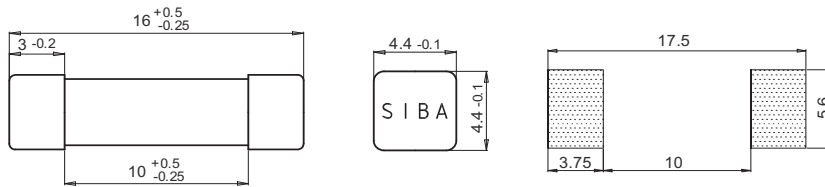

Recommended Pad Layout

Rated Current	Fusing Time Limits									
	$1.5I_n$		$2.1I_n$		$2.75I_n$		$4I_n$		$10I_n$	
	Min	Max	Min	Max	Min	Max	Min	Max	Min	Max
160mA - 2.5A	1h	—	30m	—	3s	200s	1s	40s	150ms	3s

Resistance to soldering heat, 260°C, 10s, to IEC 60068

G



RoHS

Rated Voltage

[Un]
250V_{AC}

Rated Breaking Test

Voltage Capacity
250V_{AC} 35A

Class

F



Standard(s)

IEC 60127-3/3
EN 60127-3/3
VDE 0820-3/3

8.4mmx7.6mm - Thermoplastic, Temperature Resistant, Self Extinguishing

Rated Current I_n [A]	x=0, Long Leads x=5, Short Leads		Rated Breaking Current [A]	Voltage Drop [mV]	Power Dissipation @ 1.5I _n [mW]	Pre-arcing I ² t [A ² s]	Approvals S - Semko	Marking
	Article Number	UL rec						
0.050	1640X0.0.050	✓	35A @ 250V _{AC}	820	95	0.0003	S	
0.063	1640X0.0.063	✓	35A @ 250V _{AC}	750	110	0.0007	S	
0.080	1640X0.0.080	✓	35A @ 250V _{AC}	630	120	0.0015	S	
0.100	1640X0.0.100	✓	35A @ 250V _{AC}	550	155	0.0035	S	
0.125	1640X0.0.125	✓	35A @ 250V _{AC}	550	175	0.006	S	
0.160	1640X0.0.160	✓	35A @ 250V _{AC}	460	210	0.011	S	
0.200	1640X0.0.200	✓	35A @ 250V _{AC}	150	80	0.018	S	
0.250	1640X0.0.250	✓	35A @ 250V _{AC}	140	90	0.036	S	
0.315	1640X0.0.315	✓	35A @ 250V _{AC}	130	120	0.050	S	
0.400	1640X0.0.400	✓	35A @ 250V _{AC}	120	140	0.10	S	
0.500	1640X0.0.500	✓	35A @ 250V _{AC}	110	160	0.18	S	
0.630	1640X0.0.630	✓	35A @ 250V _{AC}	100	180	0.33	S	
0.800	1640X0.0.800	✓	35A @ 250V _{AC}	90	200	0.14	S	
1	1640X0.1	✓	35A @ 250V _{AC}	80	220	0.24	S	
1.25	1640X0.1.25	✓	35A @ 250V _{AC}	75	260	0.35	S	
1.6	1640X0.1.6	✓	35A @ 250V _{AC}	70	350	0.60	S	
2	1640X0.2	✓	35A @ 250V _{AC}	65	380	1.2	S	
2.5	1640X0.2.5	✓	35A @ 250V _{AC}	60	420	2.0	S	
3.15	1640X0.3.15	✓	35A @ 250V _{AC}	60	580	3.5	S	
4	1640X0.4	✓	40A @ 250V _{AC}	60	700	6.2	S	
5	1640X0.5	✓	50A @ 250V _{AC}	60	900	13	S	
6.3	1640X0.6.3	✓	63A @ 250V _{AC}	60	1 100	19	S	

X=0 - Long leads

X=5 - Short leads

Tape reel ordering, add following suffix to article number

GT - (1 000 pieces on tape reel)

IP - (2 000 pieces)

e.g. 164000.3.15GT

Time-Current Characteristics

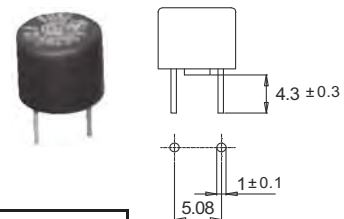
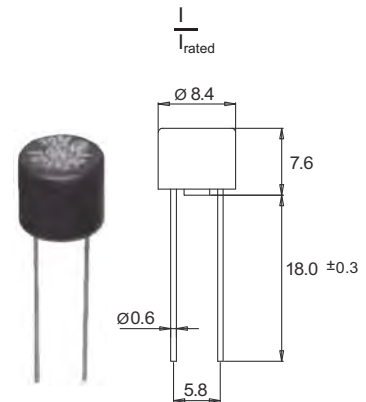
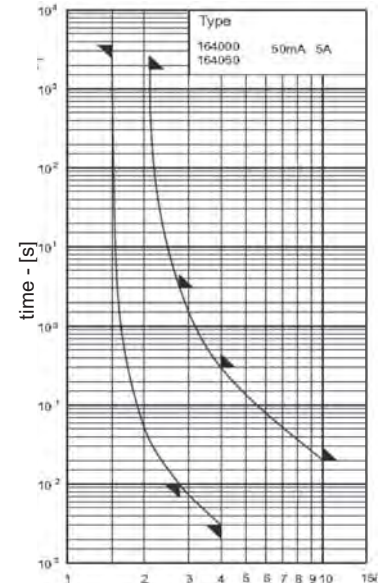

Rated Current	Fusing Time Limits									
	1.5I _n		2.1I _n		2.75I _n		4I _n		10I _n	
	Min	Max	Min	Max	Min	Max	Min	Max	Min	Max
50mA - 6.3A	1h	—	30m	—	10ms	3s	3ms	300ms	—	20ms



Dimensions
[mm]

SIBA LLC

29 Fairfield Place
West Caldwell, New Jersey 07006

e-mail: info@sibafuse.com

www.siba-fuses.us

G   **Rated Voltage** [Un] 250V_{AC} **Rated Breaking Test** Voltage 250V_{AC} Capacity 50A **Class** F **Standard(s)** UL 248-14 IEC 60127-4/2

8.4mmx7.6mm - Thermoplastic, Temperature Resistant, Self Extinguishing

Rated Current I _n [A]	x=0, Long Leads x=5, Short Leads Article Number	UL	Rated Breaking Current [A]	Voltage Drop [mV]	Power Dissipation @ 1.0I _n [mW]	Pre-arcing I ² t [A ² s]	Approvals	Marking
0.050	1645X0.0.050	✓	50A @ 250V _{AC}	2 400	120	0.0001		
0.063	1645X0.0.063	✓	50A @ 250V _{AC}	1 350	85	0.0003		
0.080	1645X0.0.080	✓	50A @ 250V _{AC}	1 200	95	0.0007		
0.100	1645X0.0.100	✓	50A @ 250V _{AC}	1 100	110	0.0015		
0.125	1645X0.0.125	✓	50A @ 250V _{AC}	1 000	125	0.003		
0.160	1645X0.0.160	✓	50A @ 250V _{AC}	950	155	0.0075		
0.200	1645X0.0.200	✓	50A @ 250V _{AC}	850	170	0.013		
0.250	1645X0.0.250	✓	50A @ 250V _{AC}	240	60	0.02		
0.315	1645X0.0.315	✓	50A @ 250V _{AC}	230	75	0.03		
0.400	1645X0.0.400	✓	50A @ 250V _{AC}	220	90	0.055		
0.500	1645X0.0.500	✓	50A @ 250V _{AC}	210	105	0.1		
0.630	1645X0.0.630	✓	50A @ 250V _{AC}	200	130	0.19		
0.800	1645X0.0.800	✓	50A @ 250V _{AC}	190	155	0.36		
1	1645X0.1	✓	50A @ 250V _{AC}	180	180	0.14		
1.25	1645X0.1.25	✓	50A @ 250V _{AC}	170	215	0.24		
1.6	1645X0.1.6	✓	50A @ 250V _{AC}	160	260	0.34		
2	1645X0.2	✓	50A @ 250V _{AC}	150	300	0.56		
2.5	1645X0.2.5	✓	50A @ 250V _{AC}	140	350	1.1		
3.15	1645X0.3.15	✓	50A @ 250V _{AC}	130	410	2		
4	1645X0.4	✓	50A @ 250V _{AC}	120	480	3.2		
5	1645X0.5	✓	50A @ 250V _{AC}	110	550	6.2		
6.3	1645X0.6.3	✓	50A @ 250V _{AC}	100	630	14		
8	1645X0.8	✓	50A @ 250V _{AC}	90	720	24		
10	1645X0.10	✓	50A @ 250V _{AC}	90	900	40		

X=0 - Long leads
X=5 - Short leads

Tape reel ordering, add following suffix to article number

- GT - (1 000 pieces on tape reel)
- IP - (2 000 pieces)
- e.g. 164500.1.25GT

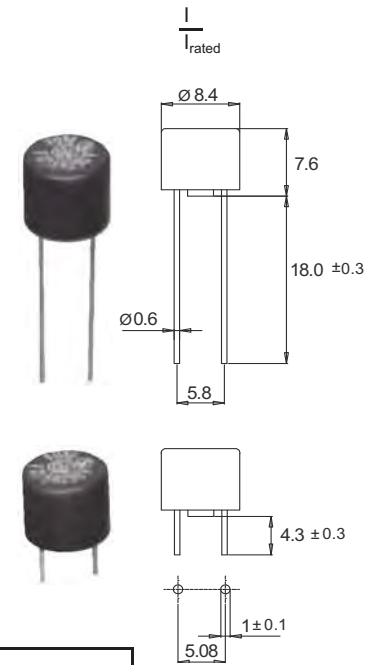
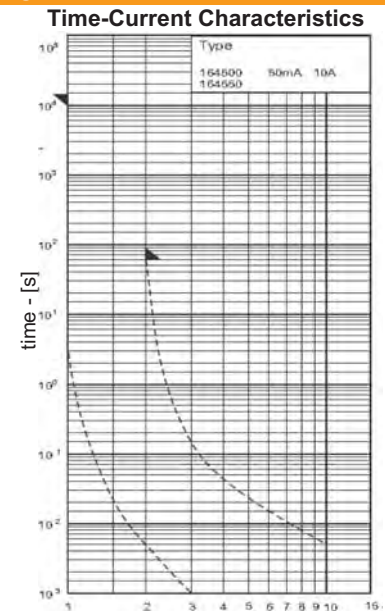

Rated Current	Fusing Time Limits									
	1I _n		1.35I _n		1.50I _n		2.00I _n			
	Min	Max	Min	Max	Min	Max	Min	Max	Min	Max
50mA - 6.3A	4h	—	—	—	—	—	—	60s	—	—

Dimensions [mm]

G

Rated Voltage [Un] 250V _{AC}	Rated Breaking Test Voltage 250V _{AC}	Capacity 35A	Class M	Standard(s) IEC 60127-3
--	---	-----------------	-------------------	-----------------------------------

8.4mmx7.6mm - Thermoplastic, Temperature Resistant, Self Extinguishing

Rated Current I_n [A]	x=0, Long Leads x=5, Short Leads		Rated Breaking Current [A]	Voltage Drop [mV]	Power Dissipation @ 1.5I _n [mW]	Pre-arcing I ² t [A ² s]	Approvals	Marking
	Article Number	UL rec						
0.160	1650X0.0.160		35A @ 250V _{AC}	325	140	0.075		
0.200	1650X0.0.200		35A @ 250V _{AC}	120	80	0.02		
0.250	1650X0.0.250		35A @ 250V _{AC}	120	90	0.036		
0.315	1650X0.0.315		35A @ 250V _{AC}	120	120	0.05		
0.400	1650X0.0.400		35A @ 250V _{AC}	110	140	0.11		
0.500	1650X0.0.500		35A @ 250V _{AC}	100	160	0.2		
0.630	1650X0.0.630		35A @ 250V _{AC}	90	80	0.33		
0.800	1650X0.0.800		35A @ 250V _{AC}	80	140	0.58		
1	1650X0.1		35A @ 250V _{AC}	70	160	0.9		
1.25	1650X0.1.25		35A @ 250V _{AC}	65	190	1.4		
1.6	1650X0.1.6		35A @ 250V _{AC}	65	200	2.5		
2	1650X0.2		35A @ 250V _{AC}	60	350	3.1		
2.5	1650X0.2.5		35A @ 250V _{AC}	55	380	5.1		
3.15	1650X0.3.15		35A @ 250V _{AC}	55	510	9.9		
4	1650X0.4		40A @ 250V _{AC}	50	550	16		

X=0 - Long leads

X=5 - Short leads

Tape reel ordering, add following suffix to article number

GT - (1 000 pieces on tape reel)



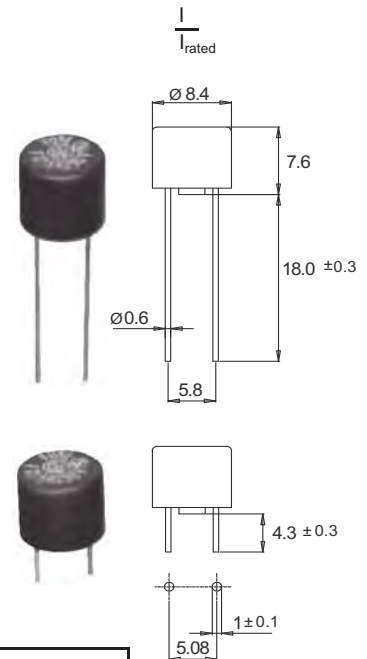
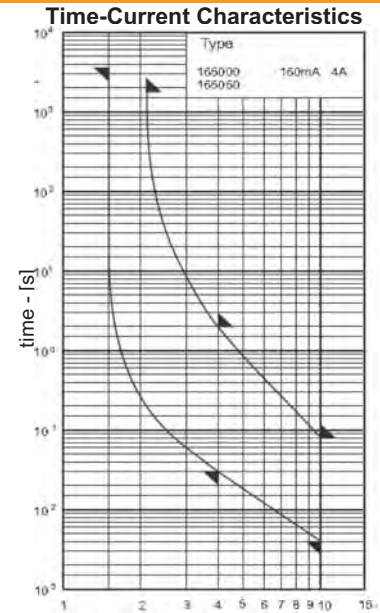

IP - (2 000 pieces)

e.g. 165000.1.25GT



Rated Current	Fusing Time Limits									
	1.5I _n		2.1I _n		2.75I _n		4I _n		10I _n	
	Min	Max	Min	Max	Min	Max	Min	Max	Min	Max
50mA - 6.3A	1h	—	—	30m	—	—	30ms	2s	4ms	80ms

Dimensions [mm]

G    **Rated Voltage** [Un] 250V_{AC} **Rated Breaking Test Voltage** 250V_{AC} **Capacity** 35A **Class** T  **Standard(s)** IEC 60127-43/4 EN 60127-43/4 VDE 0820 - 3/4

8.4mmx7.6mm - Thermoplastic, Temperature Resistant, Self Extinguishing

Rated Current I _n [A]	x=0, Long Leads x=5, Short Leads Article Number	UL rec	Rated Breaking Current [A]	Voltage Drop [mV]	Power Dissipation @ 1.5I _n [mW]	Pre-arcing I ² t [A ² s]	Approvals S - Semko V - VDE	Marking
0.040	1660X0.0.040	✓	35A @ 250V _{AC}	530	60	0.015	S V	
0.050	1660X0.0.050	✓	35A @ 250V _{AC}	490	70	0.017	S V	
0.063	1660X0.0.063	✓	35A @ 250V _{AC}	390	80	0.02	S V	
0.080	1660X0.0.080	✓	35A @ 250V _{AC}	300	90	0.035	S V	
0.100	1660X0.0.100	✓	35A @ 250V _{AC}	260	100	0.06	S V	
0.125	1660X0.0.125	✓	35A @ 250V _{AC}	180	110	0.12	S V	
0.160	1660X0.0.166	✓	35A @ 250V _{AC}	170	130	0.21	S V	
0.200	1660X0.0.200	✓	35A @ 250V _{AC}	160	140	0.32	S V	
0.250	1660X0.0.250	✓	35A @ 250V _{AC}	150	150	0.50	S V	
0.315	1660X0.0.315	✓	35A @ 250V _{AC}	140	160	0.8	S V	
0.400	1660X0.0.400	✓	35A @ 250V _{AC}	130	170	1.1	S V	
0.500	1660X0.0.500	✓	35A @ 250V _{AC}	120	180	1.8	S V	
0.630	1660X0.0.630	✓	35A @ 250V _{AC}	110	200	3.2	S V	
0.800	1660X0.0.800	✓	35A @ 250V _{AC}	100	220	5.2	S V	
1	1660X0.1	✓	35A @ 250V _{AC}	85	240	8	S V	
1.25	1660X0.1.25	✓	35A @ 250V _{AC}	75	290	12	S V	
1.6	1660X0.1.6	✓	35A @ 250V _{AC}	70	350	22	S V	
2	1660X0.2	✓	35A @ 250V _{AC}	70	480	30	S V	
2.5	1660X0.2.5	✓	35A @ 250V _{AC}	70	520	46	S V	
3.15	1660X0.3.15	✓	35A @ 250V _{AC}	70	600	80	S V	
4	1660X0.4	✓	40A @ 250V _{AC}	70	800	130	S V	
5	1660X0.5	✓	50A @ 250V _{AC}	70	1 000	130	S V	
6.3	1660X0.6.3	✓	63A @ 250V _{AC}	70	1 200	230	S V	

X=0 - Long leads
X=5 - Short leads

Tape reel ordering, add following suffix to article number

GT - (1 000 pieces on tape reel)

IP - (2 000 pieces)

e.g. 166000.3.15GT

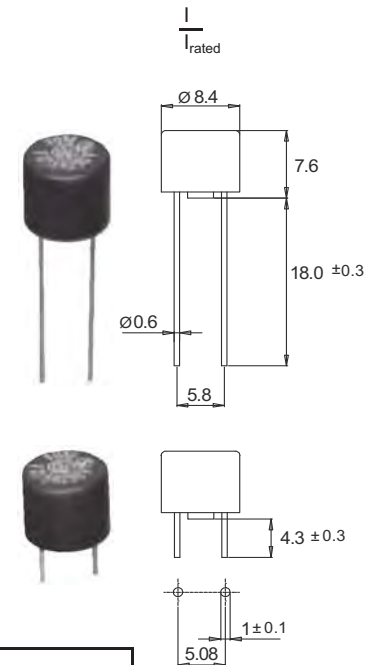
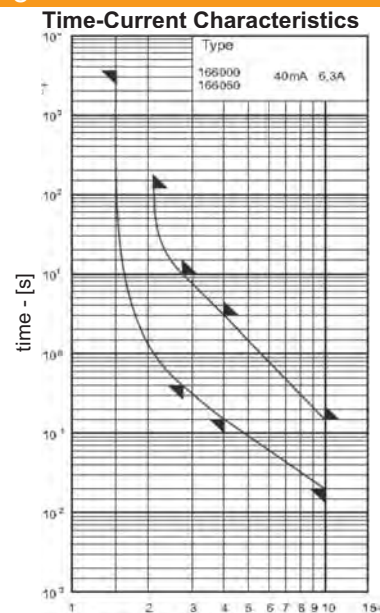

Rated Current	Fusing Time Limits									
	1.5I _n		2.1I _n		2.75I _n		4I _n		10I _n	
	Min	Max	Min	Max	Min	Max	Min	Max	Min	Max
50mA - 6.3A	1h	—	—	2m	400ms	10s	150ms	3s	20ms	150ms

Dimensions [mm]

G **Rated Voltage** [Un] 250V_{AC} **Rated Breaking Test Voltage** 250V_{AC} **Capacity** 50A **Class** T **Standard(s)** UL 248-14 CSA C22.s No 248.14

8.4mmx7.6mm - Thermoplastic, Temperature Resistant, Self Extinguishing

Rated Current I _n [A]	x=0, Long Leads x=5, Short Leads Article Number	UL	Rated Breaking Current [A]	Voltage Drop [mV]	Power Dissipation @ 1.5I _n [mW]	Pre-arcing I ² t [A ² s]	Approvals S - Semko	Marking
0.050	1665X0.0.050	✓	50A @ 250V _{AC}	800	40	0.015		
0.063	1665X0.0.063	✓	50A @ 250V _{AC}	700	45	0.017		
0.080	1665X0.0.080	✓	50A @ 250V _{AC}	600	50	0.02		
0.100	1665X0.0.100	✓	50A @ 250V _{AC}	500	50	0.025		
0.125	1665X0.0.125	✓	50A @ 250V _{AC}	400	50	0.03		
0.160	1665X0.0.160	✓	50A @ 250V _{AC}	350	55	0.07		
0.200	1665X0.0.200	✓	50A @ 250V _{AC}	300	60	0.14		
0.250	1665X0.0.250	✓	50A @ 250V _{AC}	250	65	0.25		
0.315	1665X0.0.315	✓	50A @ 250V _{AC}	240	75	0.42		
0.400	1665X0.0.400	✓	50A @ 250V _{AC}	230	95	0.53		
0.500	1665X0.0.500	✓	50A @ 250V _{AC}	220	110	1.0		
0.630	1665X0.0.630	✓	50A @ 250V _{AC}	170	110	1.5		
0.800	1665X0.0.800	✓	50A @ 250V _{AC}	150	120	3.1		
1	1665X0.1	✓	50A @ 250V _{AC}	130	130	4.8		
1.25	1665X0.1.25	✓	50A @ 250V _{AC}	150	190	5.7		
1.6	1665X0.1.6	✓	50A @ 250V _{AC}	145	235	11		
2	1665X0.2	✓	50A @ 250V _{AC}	125	250	18		
2.5	1665X0.2.5	✓	50A @ 250V _{AC}	120	300	25		
3.15	1665X0.3.15	✓	50A @ 250V _{AC}	110	350	40		
4	1665X0.4	✓	50A @ 250V _{AC}	100	400	72		
5	1665X0.5	✓	50A @ 250V _{AC}	95	475	130		
6.3	1665X0.6.3	✓	50A @ 250V _{AC}	90	570	130		
8	1665X0.8	✓	50A @ 250V _{AC}	90	720	230		
10	1665X0.10	✓	50A @ 250V _{AC}	90	900	370		

X=0 - Long leads
X=5 - Short leads

Tape reel ordering, add following suffix to article number

- GT - (1 000 pieces on tape reel)
- IP - (2 000 pieces)
- e.g. 166500.3.15GT

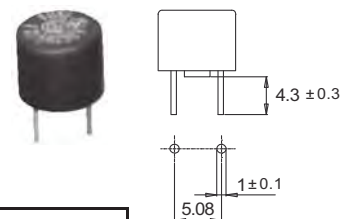
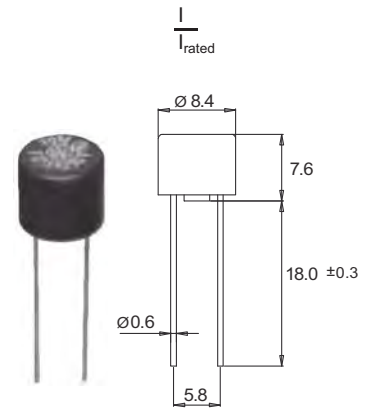
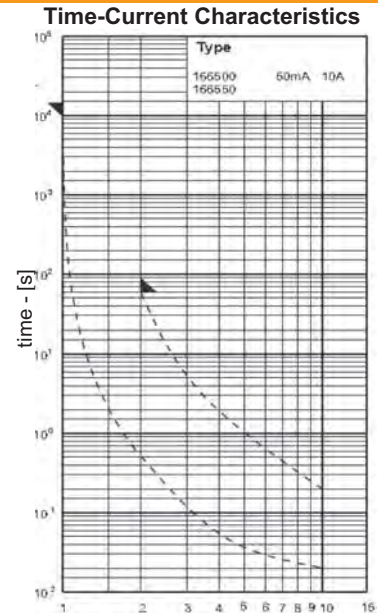

Rated Current	Fusing Time Limits									
	1I _n		1.35I _n		1.50I _n		2.00I _n			
	Min	Max	Min	Max	Min	Max	Min	Max	Min	Max
50mA - 10A	4h	—	—	—	—	—	—	60s	—	—

Dimensions [mm]

G **Rated Voltage** [Un] **Rated Breaking Test** **Class** **Standard(s)**
 E167295 **250V_{AC}** **Voltage Capacity** **F** **UL 248-14**
250V_{AC} **50A**
2.3mmx8mm - Ceramic Tube w/Heat Shrink Tubing, Leads Tinned

Rated Current I_n [A]	Article Number	UL	Rated Breaking Current [A]	Voltage Drop [mV]	Power Dissipation @ 1.5 I_n [mW]	Pre-arcing I^2t [A ² s]	Approvals
0.063	196000.0.063	✓	300A @ 125V _{DC} 50A @ 125V _{AC}	2 250	7.21	0.0002	
0.125	196000.0.125	✓	300A @ 125V _{DC} 50A @ 125V _{AC}	1 500	2.78	0.001	
0.250	196000.0.250	✓	300A @ 125V _{DC} 50A @ 125V _{AC}	1 000	0.60	0.007	
0.375	196000.0.375	✓	300A @ 125V _{DC} 50A @ 125V _{AC}	1 000	0.40	0.006	
0.500	196000.0.500	✓	300A @ 125V _{DC} 50A @ 125V _{AC}	1 000	0.27	0.018	
0.750	196000.0.750	✓	300A @ 125V _{DC} 50A @ 125V _{AC}	275	0.16	0.04	
1	196000.1	✓	300A @ 125V _{DC} 50A @ 125V _{AC}	275	0.12	0.094	
1.5	196000.1.5	✓	300A @ 125V _{DC} 50A @ 125V _{AC}	275	0.063	0.33	
2	196000.2	✓	300A @ 125V _{DC} 50A @ 125V _{AC}	250	0.057	0.41	
3	196000.3	✓	300A @ 125V _{DC} 50A @ 125V _{AC}	250	0.029	1.5	
4	196000.4	✓	300A @ 125V _{DC} 50A @ 125V _{AC}	225	0.018	3.2	
5	196000.5	✓	300A @ 125V _{DC} 50A @ 125V _{AC}	225	0.017	4.1	
7	196000.7	✓	300A @ 125V _{DC} 50A @ 125V _{AC}	150	0.013	11	
10	196000.10	✓ ¹	50A @ 125V _{AC}	125	0.06	30	

¹ UL recognition only

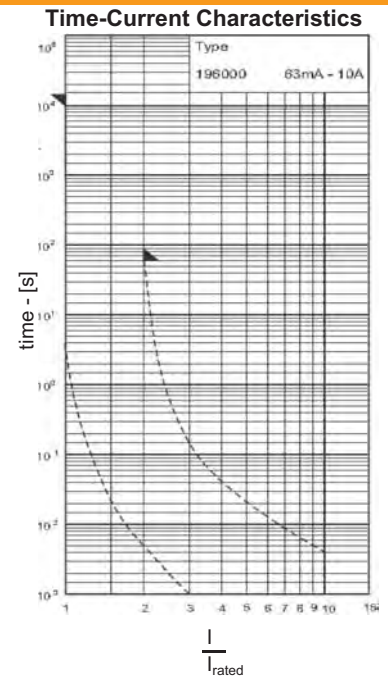

Tape reel ordering, add following suffix to article number

GT - (5 000 pieces on tape reel)

e.g. 196000.10GT

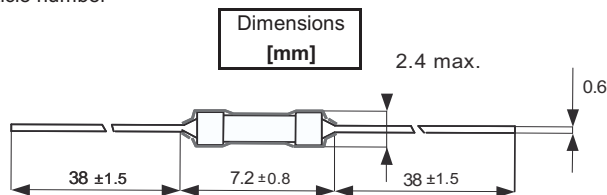

Rated Current	Fusing Time Limits									
	1 I_n		1.35 I_n		1.50 I_n		2.00 I_n			
	Min	Max	Min	Max	Min	Max	Min	Max	Min	Max
63mA - 6.3A	4h	—	—	—	—	—	—	5s	—	—

G **Rated Voltage** [Un] 250V_{AC} **Rated Breaking Test Voltage** 250V_{AC} **Capacity** 50A **Class** FF **Standard(s)**

E180276

5mmx20mm - Ceramic Tube w/Filler, Contacts - Brass, Nickel Plated

Rated Current I _n [A]	Article Number	UL rec	Rated Breaking Current [A]	Voltage Drop [mV]	Power Dissipation @ 1.0I _n [mW]	Pre-arcing I ² t [A ² s]	Approvals
0.100	7000140.0.100		300kA @ 250V _{AC}	4 000	0.4	0.0016	
0.125	7000140.0.125	✓	300kA @ 250V _{AC}	3 500	0.5	0.0024	
0.160	7000140.0.160	✓	300kA @ 250V _{AC}	1 300	0.3	0.004	
0.200	7000140.0.200	✓	300kA @ 250V _{AC}	600	0.2	0.008	
0.250	7000140.0.250	✓	300kA @ 250V _{AC}	550	0.2	0.019	
0.315	7000140.0.315	✓	300kA @ 250V _{AC}	500	0.2	0.03	
0.400	7000140.0.400	✓	300kA @ 250V _{AC}	500	0.2	0.065	
0.500	7000140.0.500	✓	300kA @ 250V _{AC}	550	0.3	0.12	
0.630	7000140.0.630	✓	300kA @ 250V _{AC}	600	0.4	0.17	
0.800	7000140.0.800	✓	300kA @ 250V _{AC}	600	0.5	0.26	
1	7000140.1	✓	300kA @ 250V _{AC}	600	0.6	0.17	
1.25	7000140.1.25	✓	300kA @ 250V _{AC}	400	0.5	0.26	
1.6	7000140.1.6	✓	300kA @ 250V _{AC}	400	0.7	0.31	
2	7000140.2	✓	300kA @ 250V _{AC}	400	0.8	0.64	
2.5	7000140.2.5	✓	300kA @ 250V _{AC}	400	1.0	0.88	
3.15	7000140.3.15	✓	300kA @ 250V _{AC}	400	1.3	1.6	
4	7000140.4	✓	300kA @ 250V _{AC}	350	1.4	3.2	
5	7000140.5	✓	300kA @ 250V _{AC}	350	1.8	5.9	
6.3	7000140.6.3		300kA @ 250V _{AC}	300	1.9	10	
8	7000140.8		300kA @ 250V _{AC}	300	2.4	19	
10	7000140.10		300kA @ 250V _{AC}	300	3.0	30	
12.5	7000140.12.5		300kA @ 250V _{AC}	200	2.5	115	

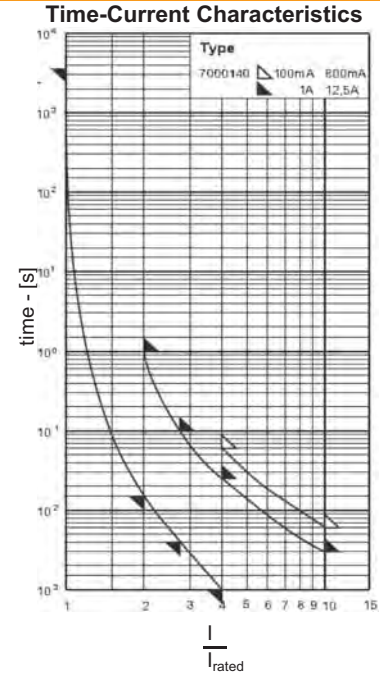

Weight (kg per 100)
0.14
Units per Package
10

For 6.3A and higher, consideration should be given to heat dissipation

IP - (1 000 pieces)
e.g. 70 001 140.3.15IP



Dimensions [mm]



Rated Current	Fusing Time Limits									
	1I _n		2I _n		2.75I _n		4I _n		10I _n	
	Min	Max	Min	Max	Min	Max	Min	Max	Min	Max
100mA - 800A	1h	—	—	—	—	—	—	60ms	—	6ms
1A - 12.5A	1h	—	—	1s	4ms	100ms	1ms	25ms	—	3ms

G **Rated Voltage** **Rated Breaking Test** **Class** **Standard(s)**
[Un] **Voltage** **Capacity** **FF**
400V_{AC} **400V_{AC}** **10kA**

E180276

5mmx20mm - Ceramic Tube w/Filler, Contacts - Brass, Nickel Plated

Rated Current I_n [A]	Article Number	UL rec	Rated Breaking Current [A]	Voltage Drop [mV]	Power Dissipation @ 1.0 I_n [mW]	Pre-arcing I^2t [A ² s]	Approvals
0.100	7000740.0.100		10kA @ 400V _{AC}	4 000	0.4	0.0016	
0.125	7000740.0.125		10kA @ 400V _{AC}	3 500	0.5	0.0024	
0.160	7000740.0.160		10kA @ 400V _{AC}	1 300	0.3	0.004	
0.200	7000740.0.200		10kA @ 400V _{AC}	600	0.2	0.01	
0.250	7000740.0.250		10kA @ 400V _{AC}	550	0.2	0.02	
0.315	7000740.0.315		10kA @ 400V _{AC}	500	0	0.04	
0.400	7000740.0.400		10kA @ 400V _{AC}	500	0.2	0.07	
0.500	7000740.0.500		10kA @ 400V _{AC}	550	0.3	0.07	
0.630	7000740.0.630		10kA @ 400V _{AC}	600	0.4	0.15	
0.800	7000740.0.800		10kA @ 400V _{AC}	600	0.5	0.32	
1	7000740.1		10kA @ 400V _{AC}	600	0.6	0.32	
1.25	7000740.1.25		10kA @ 400V _{AC}	400	0.5	0.20	
1.6	7000740.1.6		10kA @ 400V _{AC}	400	0.7	0.31	
2	7000740.2		10kA @ 400V _{AC}	400	0.8	0.64	
2.5	7000740.2.5		10kA @ 400V _{AC}	400	1.0	0.88	
3.15	7000740.3.15		10kA @ 400V _{AC}	400	1.3	1.6	
4	7000740.4		10kA @ 400V _{AC}	350	1.4	3.2	
					@ 1.5 I_n		
6.3	7000740.6.3	✓	300kA @ 250V _{AC}	250	2.8	1.6	
8	7000740.8	✓	300kA @ 250V _{AC}	230	3.0	4.5	
10	7000740.10	✓	300kA @ 250V _{AC}	180	3.4	8.8	
12.5	7000740.12.5	✓	300kA @ 250V _{AC}	150	4.0	15	
16	7000740.16		10kA @ 125V _{AC}	130	3.8	46	

Weight (kg per 100)
0.14
Units per Package
10

For 6.3A and higher, consideration should be given to heat dissipation



Dimensions [mm]

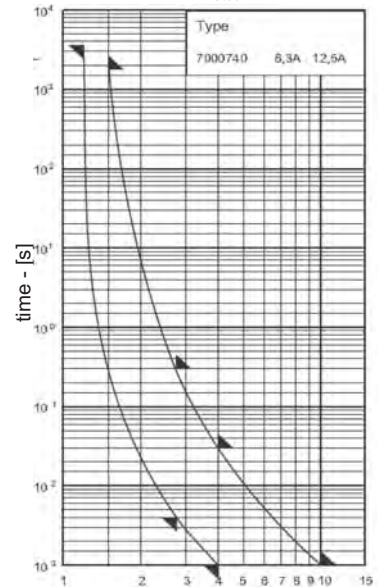
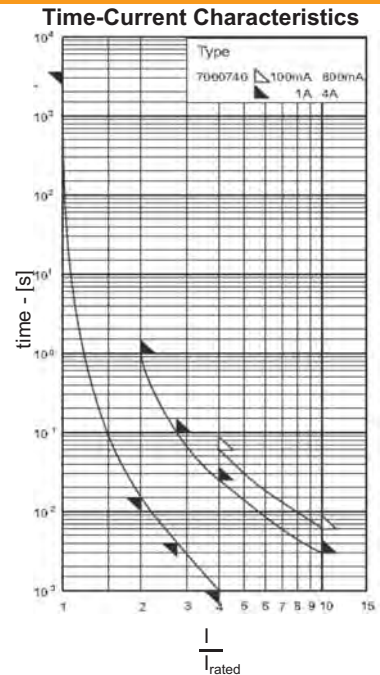
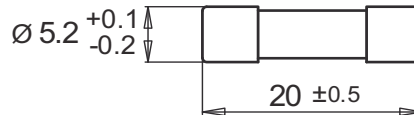

Rated Current	Fusing Time Limits									
	1 I_n		2 I_n		2.75 I_n		4 I_n		10 I_n	
	Min	Max	Min	Max	Min	Max	Min	Max	Min	Max
100mA - 800A	1h	—	—	—	—	—	—	60ms	—	6ms
1A - 4A	1h	—	—	1s	4ms	100ms	1ms	25ms	—	3ms
Rated Current	1.2 I_n		2 I_n		2.75 I_n		4 I_n		10 I_n	
1A - 4A	1h	—	—	30m	4ms	300ms	1ms	30ms	—	1ms

IP - (1 000 pieces)
e.g. 70 007 40.1.25IP

	Rated Voltage	Rated Breaking Test	Class	Standard(s)
	[Un] 660V _{AC/DC}	Voltage 660V _{AC/DC}	Capacity 100kA	aR{FF}

5mmx20mm - Ceramic Tube w/Filler, Contacts - Brass, Nickel Plated

Rated Current I_n [A]	Article Number	UL rec	Rated Breaking Current [A]	Voltage Drop [mV]	Power Dissipation @ 1.0I _n [mW]	Pre-arcing I ² t [A ² s]	Approvals
0.100	7018040.0.100		100kA @ 660V _{AC/DC}	1 000	0.1	0.0009	
0.200	7018040.0.200		100kA @ 660V _{AC/DC}	600	0.2	0.01	
0.250	7018040.0.250		100kA @ 660V _{AC/DC}	550	0.2	0.02	
0.500	7018040.0.500		100kA @ 660V _{AC/DC}	550	0.3	0.07	

Short Circuit Protection Only
Time-Current Characteristics

Weight (kg per 100)	0.14
Units per Package	10

IP - (1 000 pieces)
e.g. 70 180 40.3.15IP

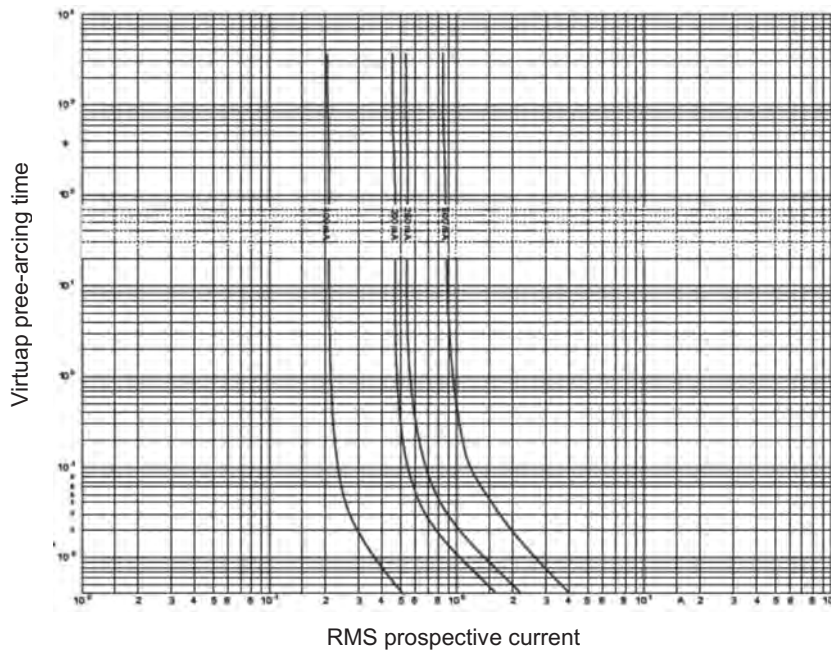

Dimensions [mm]

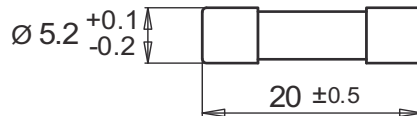

Rated Current	Fusing Time Limits									
	1I _n		2I _n		2.75I _n		4I _n		10I _n	
	Min	Max	Min	Max	Min	Max	Min	Max	Min	Max
100mA - 500A	1h	—	—	—	—	—	—	60ms	—	6ms

G

Rated Voltage [Un] **Rated Breaking Test** **Class** **Standard(s)**
 250V_{AC} Voltage Capacity **F** IEC 60127-2/2
 250V_{AC} 1.5kA EN 60127-2/2
 VDE 0820 - 2/2

5mmx20mm - Glass Tube, Contacts - Brass, Nickel Plated

Rated Current I _n [A]	Article Number	UL rec	Rated Breaking Current [A]	Voltage Drop [mV]	Power Dissipation @ 1.5I _n [W]	Pre-arcing I ² t [A ² s]	Approvals S - Semko V - VDE B - BEAB
0.032	179020.0.032	✓	35A @ 250V _{AC}	10 000	0.8	0.0001	S V
0.040	179020.0.040	✓	35A @ 250V _{AC}	8 000	0.8	0.0002	S V B
0.050	179020.0.050	✓	35A @ 250V _{AC}	3 500	0.4	0.0004	S V
0.063	179020.0.063	✓	35A @ 250V _{AC}	3 500	0.5	0.0007	S V B
0.080	179020.0.080	✓	35A @ 250V _{AC}	2 500	0.5	0.0017	S V B
0.100	179020.0.100	✓	35A @ 250V _{AC}	2 200	0.6	0.0022	S V B
0.125	179020.0.125	✓	35A @ 250V _{AC}	350	0.2	0.01	S V B
0.160	179020.0.160	✓	35A @ 250V _{AC}	310	0.2	0.02	S V B
0.200	179020.0.200	✓	35A @ 250V _{AC}	290	0.2	0.01	S V B
0.250	179020.0.250	✓	35A @ 250V _{AC}	280	0.2	0.02	S V B
0.315	179020.0.315	✓	35A @ 250V _{AC}	230	0.3	0.037	S V B
0.400	179020.0.400	✓	35A @ 250V _{AC}	200	0.3	0.073	S V B
0.500	179020.0.500	✓	35A @ 250V _{AC}	160	0.3	0.16	S V B
0.630	179020.0.630	✓	35A @ 250V _{AC}	140	0.3	0.39	S V B
0.700	179020.0.700	✓	35A @ 250V _{AC}	140	0.3	0.56	
0.800	179020.0.800	✓	35A @ 250V _{AC}	130	0.4	0.8	S V B
1	179020.1	✓	35A @ 250V _{AC}	130	0.4	1.5	S V B
1.25	179020.1.25	✓	35A @ 250V _{AC}	120	0.5	2.0	S V B
1.4	179020.1.4	✓	35A @ 250V _{AC}	120	0.6	2.5	
1.5	179020.1.5	✓	35A @ 250V _{AC}	120	0.6	3.2	
1.6	179020.1.6	✓	35A @ 250V _{AC}	120	0.7	4.1	S V B
2	179020.2	✓	35A @ 250V _{AC}	120	0.7	6.2	S V B
2.5	179020.2.5	✓	35A @ 250V _{AC}	120	0.9	11	S V B
3.15	179020.3.15	✓	35A @ 250V _{AC}	120	1.0	20	S V B
3.5	179020.3.5		35A @ 250V _{AC}	110	1.2	20	
4	179020.4	✓	40A @ 250V _{AC}	100	1.3	25	S V B
5	179020.5	✓	50A @ 250V _{AC}	100	1.4	42	S V B
6.3	179020.6.3	✓	63A @ 250V _{AC}	100	1.7	79	S V B
8	179020.8		80A @ 250V _{AC}	100	2.0	125	
10	179020.10		100A @ 250V _{AC}	100	2.4	220	

Weight (kg per 100)
0.14
Units per Package
10



Dimensions [mm]

FC - 1 000 pieces with color code
 AK - with assembled leaded caps
 IP - (1 000 pieces)
 e.g. 179020.3.15IP

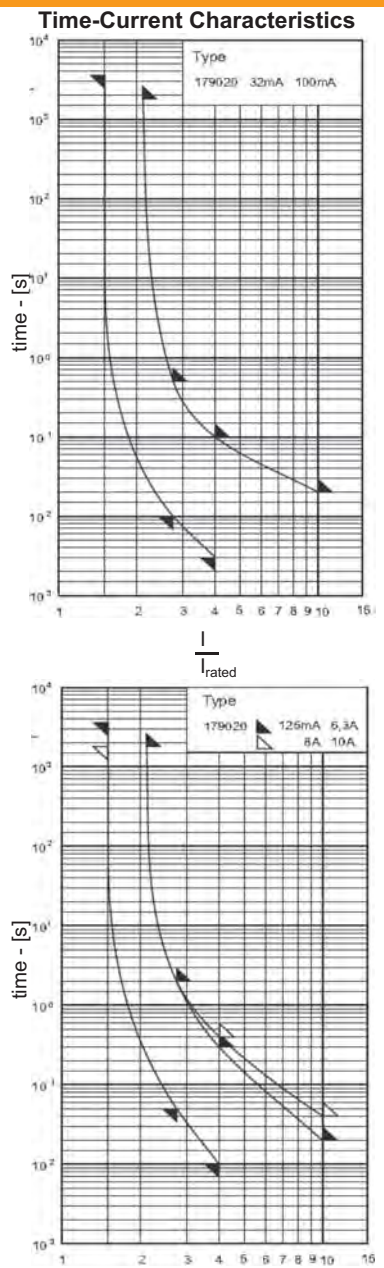
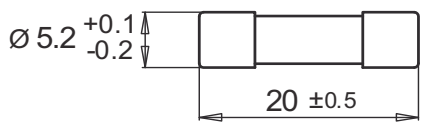

Rated Current	Fusing Time Limits									
	1.5I _n		2.1I _n		2.75I _n		4I _n		10I _n	
	Min	Max	Min	Max	Min	Max	Min	Max	Min	Max
32mA - 100mA	1h	—	—	30m	10ms	500ms	3ms	100ms	—	20ms
125mA - 6.3A	1h	—	—	30m	50ms	2s	10ms	300ms	—	20ms
8A - 10A	30m	—	—	30m	50ms	2s	10ms	400ms	—	40ms

G **Rated Voltage** [Un] 250V_{AC} **Rated Breaking Test Voltage** 250V_{AC} **Capacity** 1.5kA **Class** F **Standard(s)** IEC 60127-2/1 EN 60127-2/1 VDE 0820 - 2/1

5mmx20mm - Ceramic Tube, Contacts - Brass, Nickel Plated

Rated Current I _n [A]	Article Number	UL rec	Rated Breaking Current [A]	Voltage Drop [mV]	Power Dissipation @ 1.5I _n [W]	Pre-arcing I ² t [A ² s]	Approvals
0.050	179021.0.050		1.5kA @ 250V _{AC} ¹	4 000	0.5	0.00022	S
0.063	179021.0.063		1.5kA @ 250V _{AC} ¹	3 900	0.6	0.00037	S
0.080	179021.0.080		1.5kA @ 250V _{AC} ¹	3 200	0.7	0.00073	S
0.100	179021.0.100		1.5kA @ 250V _{AC} ¹	2 600	0.8	0.0011	S
0.125	179021.0.125		1.5kA @ 250V _{AC} ¹	360	0.2	0.01	S
0.160	179021.0.160		1.5kA @ 250V _{AC} ¹	320	0.2	0.02	S
0.200	179021.0.200	✓	1.5kA @ 250V _{AC} ¹	290	0.2	0.038	S
0.250	179021.0.250	✓	1.5kA @ 250V _{AC} ¹	280	0.3	0.073	S
0.315	179021.0.315	✓	1.5kA @ 250V _{AC} ¹	230	0.3	0.016	S
0.400	179021.0.400	✓	1.5kA @ 250V _{AC} ¹	650	0.9	0.055	S
0.500	179021.0.500	✓	1.5kA @ 250V _{AC} ¹	600	1.0	0.10	S
0.630	179021.0.630	✓	1.5kA @ 250V _{AC} ¹	550	1.1	0.19	S
0.800	179021.0.800	✓	1.5kA @ 250V _{AC} ¹	500	1.3	0.16	S
1	179021.1	✓	1.5kA @ 250V _{AC} ¹	450	1.4	0.28	S
1.25	179021.1.25	✓	1.5kA @ 250V _{AC} ¹	400	1.6	0.6	S
1.6	179021.1.6	✓	1.5kA @ 250V _{AC} ¹	350	1.8	1.0	S
2	179021.2	✓	1.5kA @ 250V _{AC} ¹	320	2.0	1.8	S
2.5	179021.2.5	✓	1.5kA @ 250V _{AC} ¹	270	2.1	3.0	S
3.15	179021.3.15	✓	1.5kA @ 250V _{AC} ¹	220	2.2	6.2	S
4	179021.4	✓	1.5kA @ 250V _{AC} ¹	180	2.3	15	S
5	179021.5	✓	1.5kA @ 250V _{AC} ¹	150	2.4	31	S
6.3	179021.6.3	✓	1.5kA @ 250V _{AC} ¹	130	2.6	52	S
8	179021.8	✓	1.5kA @ 250V _{AC} ¹	100	2.8	110	
10	179021.10	✓	1.5kA @ 250V _{AC} ¹	100	3.0	200	
12.5	179021.12.5		1.0kA @ 250V _{AC}	100	3.4	300	
16	179021.16		1.0kA @ 250V _{AC}	100	4.0	590	

Weight (kg per 100)	¹⁾ cosφ = 0.7 - 0.8
0.14	
Units per Package	
10	



Dimensions [mm]

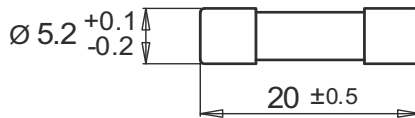

FC - 1 000 pieces with color code
 AK - with assembled leaded caps
 IP - (1 000 pieces)
 e.g. 179021.2.5IP

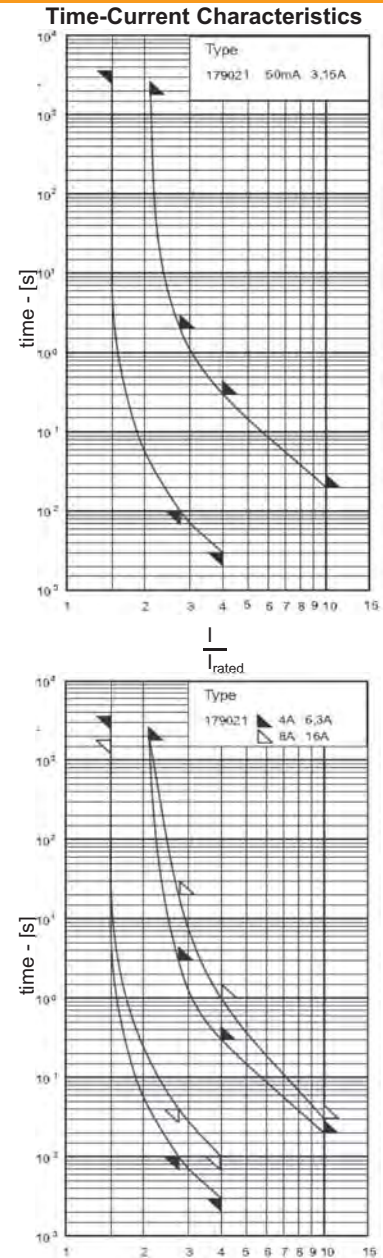

Rated Current	Fusing Time Limits									
	1.5I _n		2.1I _n		2.75I _n		4I _n		10I _n	
	Min	Max	Min	Max	Min	Max	Min	Max	Min	Max
32mA - 100mA	1h	—	—	30m	10ms	2s	3ms	300ms	—	20ms
125mA - 6.3A	1h	—	—	30m	10ms	3s	3ms	300ms	—	20ms
8A - 10A	30m	—	—	30m	40ms	20s	10ms	1s	—	30ms

G RoHS Rated Voltage [Un] 250V_{AC} Rated Breaking Test Voltage 250V_{AC} Capacity 1.5kA Class F Standard(s) DIN 41571-1

5mmx20mm - Glass Tube w/Filler, Contacts - Brass, Nickel Plated

Rated Current I _n [A]	Article Number	Rated Breaking Current [A]	Voltage Drop [mV]	Power Dissipation @ 1.5I _n [W]	Pre-arcing I ² t [A ² s]	Approvals
1.6	171100.1.6	1.0kA @ 250V _{AC}	480	1.3	1.1	
2	171100.2	1.0kA @ 250V _{AC}	400	1.5	2	
2.5	171100.2.5	1.0kA @ 250V _{AC}	400	1.6	4	
3.15	171100.3.15	1.0kA @ 250V _{AC}	240	1.7	9	
4	171100.4	1.0kA @ 250V _{AC}	240	1.9	18	
5	171100.5	1.0kA @ 250V _{AC}	230	2.3	32	
6.3	171100.6.3	1.0kA @ 250V _{AC}	170	2.8	52	
8	171100.8	300A @ 250V _{AC}	160	3.2	100	
10	171100.10	300A @ 250V _{AC}	150	3.4	200	
Weight (kg per 100)						
0.14						
Units per Package						
10						

IP - (1 000 pieces)
e.g. 171100.3.15IP

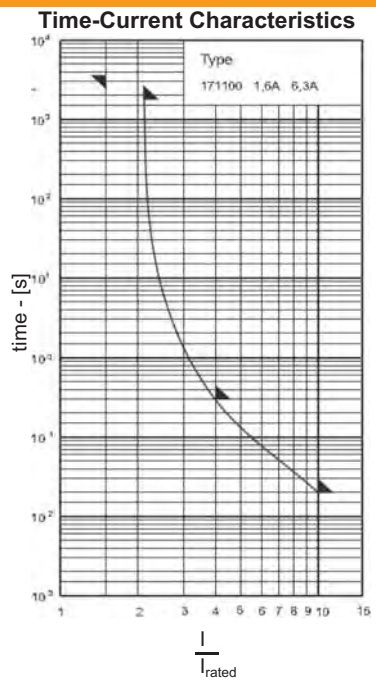

Dimensions [mm]

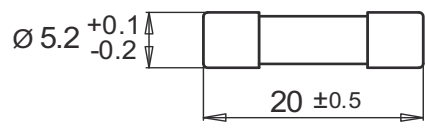

Rated Current	Fusing Time Limits									
	1.5I _n		2.1I _n		2.75I _n		4I _n		10I _n	
	Min	Max	Min	Max	Min	Max	Min	Max	Min	Max
1.6A - 6.3A	1h	—	—	30m	—	—	—	300ms	—	20ms

G Rated Voltage Rated Breaking Test Class Standard(s)

RoHS
[Un]
Voltage
Capacity
M
DIN 41571-2

250V_{AC}
250V_{AC}
80A / 1kA / 300A

5mmx20mm - Ceramic Tube w/Filler, Contacts - Brass, Nickel Plated

Rated Current I_n [A]	Article Number	Rated Breaking Current [A]	Voltage Drop [mV]	Power Dissipation @ 1.5I _n [W]	Pre-arcing I ² t [A ² s]	Approvals
No Filler						
0.032	172000.0.032	80A @ 250V _{AC}	560	0.1	0.0055	
0.040	172000.0.040	80A @ 250V _{AC}	490	0.1	0.0008	
0.050	172000.0.050	80A @ 250V _{AC}	440	0.1	0.0013	
0.063	172000.0.063	80A @ 250V _{AC}	330	0.1	0.025	
0.080	172000.0.080	80A @ 250V _{AC}	490	0.1	0.04	
0.100	172000.0.100	80A @ 250V _{AC}	330	0.1	0.07	
0.125	172000.0.125	80A @ 250V _{AC}	230	0.1	0.018	
0.160	172000.0.160	80A @ 250V _{AC}	220	0.1	0.036	
0.200	172000.0.200	80A @ 250V _{AC}	190	0.2	0.07	
0.250	172000.0.250	80A @ 250V _{AC}	150	0.2	0.19	
0.315	172000.0.315	80A @ 250V _{AC}	140	0.2	0.35	
0.400	172000.0.400	80A @ 250V _{AC}	130	0.2	0.49	
0.500	172000.0.500	80A @ 250V _{AC}	120	0.2	0.9	
0.630	172000.0.630	80A @ 250V _{AC}	110	0.2	1.4	
0.700	172000.0.700	80A @ 250V _{AC}	140	0.3	1.6	
0.800	172000.0.800	80A @ 250V _{AC}	100	0.3	3.2	
1	172000.1	80A @ 250V _{AC}	90	0.3	6.5	
1.25	172000.1.25	80A @ 250V _{AC}	80	0.3	5	
with Filler						
1.4	172100.1.4	1.0kA @ 250V _{AC}	160	0.7	2.8	
1.5	172100.1.5	1.0kA @ 250V _{AC}	160	0.8	3.0	
1.6	172100.1.6	1.0kA @ 250V _{AC}	150	0.8	6.1	
2	172100.2	1.0kA @ 250V _{AC}	130	0.8	5.2	
2.5	172100.2.5	1.0kA @ 250V _{AC}	110	0.9	10	
3.15	172100.3.15	1.0kA @ 250V _{AC}	100	1.0	20	
4	172100.4	1.0kA @ 250V _{AC}	90	1.1	37	
5	172100.5	1.0kA @ 250V _{AC}	90	1.3	72	
6.3	172100.6.3	1.0kA @ 250V _{AC}	90	1.6	130	
8	172100.8	300A @ 250V _{AC}	90	2.0	230	
10	172100.10	300A @ 250V _{AC}	90	2.5	370	

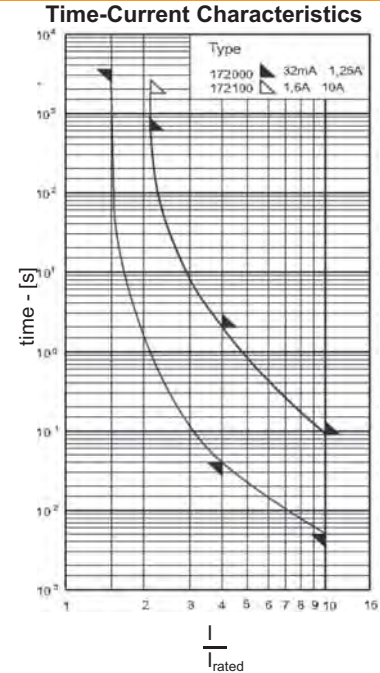

Weight (kg per 100)
0.14
Units per Package
10

Dimensions [mm]

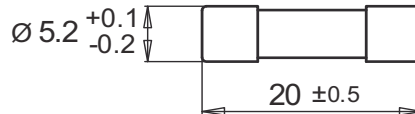

IP - (1 000 pieces)
e.g. 172100.3.15IP

Rated Current	Fusing Time Limits									
	1.5I _n		2.1I _n		2.75I _n		4I _n		10I _n	
	Min	Max	Min	Max	Min	Max	Min	Max	Min	Max
32mA - 1.25A	1h	—	—	10m	—	—	40ms	2s	5ms	90ms
1.6A - 10A	1h	—	—	30m	—	—	40ms	2s	5ms	20ms

G RoHS **Rated Voltage** [Un] **Rated Breaking Test** **Class** **Standard(s)**

250V_{AC} 250V_{AC} 1.5kA **M** DIN 41571-2

5mmx20mm - Ceramic Tube w/Filler, Contacts - Brass, Nickel Plated

Rated Current I _n [A]	Article Number	Rated Breaking Current [A]	Voltage Drop [mV]	Power Dissipation @ 1.5I _n [W]	Pre-arcing I ² t [A ² s]	Approvals
0.125	172200.0.125	1.5kA @ 250V _{AC}	230	0.1	0.018	
0.160	172200.0.160	1.5kA @ 250V _{AC}	220	0.1	0.036	
0.200	172200.0.200	1.5kA @ 250V _{AC}	190	0.2	0.07	
0.250	172200.0.250	1.5kA @ 250V _{AC}	150	0.2	0.19	
0.315	172200.0.315	1.5kA @ 250V _{AC}	140	0.2	0.35	
0.400	172200.0.400	1.5kA @ 250V _{AC}	130	0.2	0.49	
0.500	172200.0.500	1.5kA @ 250V _{AC}	120	0.2	0.09	
0.630	172200.0.630	1.5kA @ 250V _{AC}	110	0.2	0.6	
0.800	172200.0.800	1.5kA @ 250V _{AC}	140	0.3	1.0	
1	172200.1	1.5kA @ 250V _{AC}	90	0.3	1.5	
1.25	172200.1.25	1.5kA @ 250V _{AC}	80	0.3	3.1	
1.6	172200.1.6	1.5kA @ 250V _{AC}	150	0.8	6.1	
2	172200.2	1.5kA @ 250V _{AC}	130	0.8	5.2	
2.5	172200.2.5	1.5kA @ 250V _{AC}	110	0.9	10	
3.15	172200.3.15	1.5kA @ 250V _{AC}	100	1.0	20	
4	172200.4	1.5kA @ 250V _{AC}	90	1.1	37	
5	172200.5	1.5kA @ 250V _{AC}	90	1.3	72	
6.3	172200.6.3	1.5kA @ 250V _{AC}	90	1.6	130	
8	172200.8	1.5kA @ 250V _{AC}	90	2.0	230	
10	172200.10	1.5kA @ 250V _{AC}	90	2.5	370	

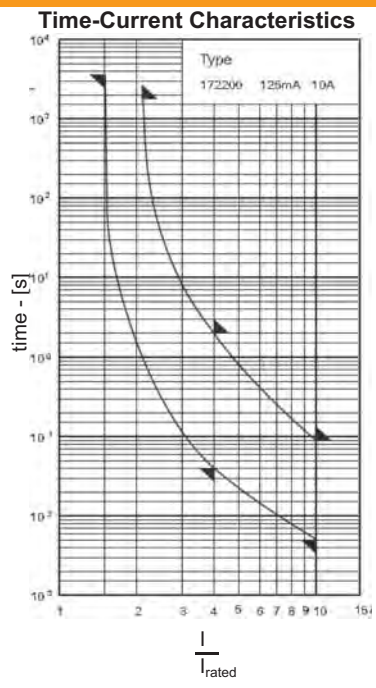

Weight (kg per 100)
0.14
Units per Package
10

IP - (1 000 pieces)
e.g. 172200.10IP



Dimensions [mm]

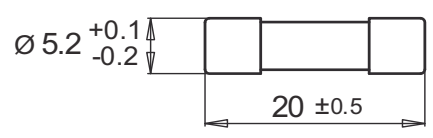

Rated Current	Fusing Time Limits									
	1.5I _n		2.1I _n		2.75I _n		4I _n		10I _n	
	Min	Max	Min	Max	Min	Max	Min	Max	Min	Max
125mA - 10A	1h	—	—	30m	—	—	40ms	2s	5ms	90ms

G



Rated Voltage
[Un]
250V_{AC}

Rated Breaking Test
Voltage
250V_{AC} Capacity
35A / 10I_{rat}

Class
T

Standard(s)
IEC 60127-2/3
EN 60127-2/3
VDE 0820 - 2/3

5mmx20mm - Glass Tube, Contacts - Brass, Nickel Plated

Rated Current I _n [A]	Article Number	UL rec	Rated Breaking Current [A]	Voltage Drop [mV]	Power Dissipation @ 1.5I _n [W]	Pre-arcing I ² t [A ² s]	Approvals S - Semko V - VDE
0.032	179120.0.032	✓	35A @ 250V _{AC}	3 000	0.2	0.01	S V
0.040	179120.0.040	✓	35A @ 250V _{AC}	2 000	0.2	0.02	S V
0.050	179120.0.050	✓	35A @ 250V _{AC}	1 500	0.2	0.035	S V
0.063	179120.0.063	✓	35A @ 250V _{AC}	1 000	0.2	0.05	S V
0.080	179120.0.080	✓	35A @ 250V _{AC}	800	0.2	0.12	S V
0.100	179120.0.100	✓	35A @ 250V _{AC}	700	0.3	0.16	S V
0.125	179120.0.125	✓	35A @ 250V _{AC}	600	0.3	0.24	S V
0.160	179120.0.160	✓	35A @ 250V _{AC}	600	0.3	0.4	S V
0.200	179120.0.200	✓	35A @ 250V _{AC}	500	0.3	0.7	S V
0.250	179120.0.250	✓	35A @ 250V _{AC}	400	0.3	1.4	S V
0.315	179120.0.315	✓	35A @ 250V _{AC}	140	0.2	0.35	S V
0.400	179120.0.400	✓	35A @ 250V _{AC}	130	0.2	0.49	S V
0.500	179120.0.500	✓	35A @ 250V _{AC}	120	0.2	0.9	S V
0.630	179120.0.630	✓	35A @ 250V _{AC}	110	0.2	1.4	S V
0.700	179120.0.700		35A @ 250V _{AC}	140	0.3	1.6	
0.800	179120.0.800	✓	35A @ 250V _{AC}	100	0.3	3.2	S V
1	179120.1	✓	35A @ 250V _{AC}	90	0.3	6.5	S V
1.25	179120.1.25	✓	35A @ 250V _{AC}	80	0.3	5.0	S V
1.4	179120.1.4		35A @ 250V _{AC}	80	0.4	5.2	
1.5	179120.1.5		35A @ 250V _{AC}	80	0.4	8.5	
1.6	179120.1.6	✓	35A @ 250V _{AC}	80	0.4	10	S V
2	179120.2	✓	35A @ 250V _{AC}	80	0.5	20	S V
2.5	179120.2.5	✓	35A @ 250V _{AC}	80	0.6	26	S V
3.15	179120.3.15	✓	35A @ 250V _{AC}	80	0.6	44	S V
3.5	179120.3.5		35A @ 250V _{AC}	80	0.8	50	
4	179120.4	ü	40A @ 250V _{AC}	80	0.8	72	S V
5	179120.5	ü	50A @ 250V _{AC}	80	1.2	130	S V
6.3	179120.6.3	ü	63A @ 250V _{AC}	70	1.3	230	S V
8	179120.8		80A @ 250V _{AC}	70	1.8	240	
10	179120.10		100A @ 250V _{AC}	70	2.4	380	
12.5	179120.12.5		125A @ 250V _{AC}	70	3.0	650	
16	179120.16		160A @ 250V _{AC}	70	3.2	1 300	
20	179120.20		200A @ 250V _{AC}	70	3.5	2 200	

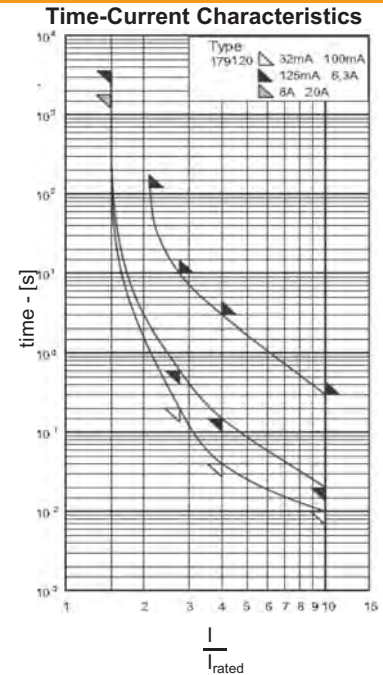

Weight (kg per 100)
0.14
Units per Package
10



Dimensions
[mm]



FC - 1 000 pieces with color code

AK - with assembled leaded caps

IP - (1 000 pieces)
e.g. 179120.1.25IP

Rated Current	Fusing Time Limits									
	1.5I _n		2.1I _n		2.75I _n		4I _n		10I _n	
	Min	Max	Min	Max	Min	Max	Min	Max	Min	Max
32mA - 100mA	1h	—	—	2m	200ms	10s	40ms	3s	10ms	300ms
125mA - 6.3A	1h	—	—	2m	600ms	10s	150ms	3s	20ms	300ms
8A - 20A	30m	—	—	2m	600ms	10s	150ms	3s	20ms	300ms

SIBA LLC

29 Fairfield Place
West Caldwell, New Jersey 07006

e-mail: info@sibafuse.com

www.siba-fuses.us

G

Rated Voltage [Un] **Rated Breaking Test** **Class** **Standard(s)**

250V_{AC} Voltage Capacity 150A T IEC 60127-2/6
250V_{AC} 150A EN 60127-2/6
VDE 0820 - 2/6

5mmx20mm - Glass Tube, Contacts - Brass, Nickel Plated

Rated Current I _n [A]	Article Number	Rated Breaking Current [A]	Voltage Drop [mV]	Power Dissipation @ 1.5I _n [W]	Pre-arcing I ² t [A ² s]	Approvals S - Semko V - VDE
0.032	179150.0.032	150A @ 250V _{AC}	3 000	0.2	0.01	
0.040	179150.0.040	150A @ 250V _{AC}	2 000	0.2	0.02	
0.050	179150.0.050	150A @ 250V _{AC}	1 500	0.2	0.035	
0.063	179150.0.063	150A @ 250V _{AC}	1 000	0.2	0.05	
0.080	179150.0.080	150A @ 250V _{AC}	800	0.2	0.12	
0.100	179150.0.100	150A @ 250V _{AC}	700	0.3	0.16	
0.125	179150.0.125	150A @ 250V _{AC}	600	0.3	0.24	
0.160	179150.0.160	150A @ 250V _{AC}	600	0.3	0.4	
0.200	179150.0.200	150A @ 250V _{AC}	500	0.3	0.7	
0.250	179150.0.250	150A @ 250V _{AC}	400	0.3	1.4	
0.315	179150.0.315	150A @ 250V _{AC}	140	0.2	0.35	
0.400	179150.0.400	150A @ 250V _{AC}	130	0.2	0.49	
0.500	179150.0.500	150A @ 250V _{AC}	120	0.2	0.9	S V
0.630	179150.0.630	150A @ 250V _{AC}	110	0.2	1.4	S V
0.800	179150.0.800	150A @ 250V _{AC}	100	0.3	3.2	S V
1	179150.1	150A @ 250V _{AC}	90	0.3	6.5	S V
1.25	179150.1.25	150A @ 250V _{AC}	80	0.3	5.0	S V
1.6	179150.1.6	150A @ 250V _{AC}	80	0.4	10	S V
2	179150.2	150A @ 250V _{AC}	80	0.5	20	S V
2.5	179150.2.5	150A @ 250V _{AC}	80	0.6	26	S V
3.15	179150.3.15	150A @ 250V _{AC}	80	0.6	44	S V
4	179150.4	150A @ 250V _{AC}	80	0.8	72	S V
5	179150.5	150A @ 250V _{AC}	80	1.2	130	
6.3	179150.6.3	150A @ 250V _{AC}	70	1.3	230	
8	179150.8	150A @ 250V _{AC}	70	1.8	240	
10	179150.10	150A @ 250V _{AC}	70	2.4	380	

Weight (kg per 100)
0.14
Units per Package
10

IP - (1 000 pieces)
e.g. 179150.0.63IP



Dimensions [mm]

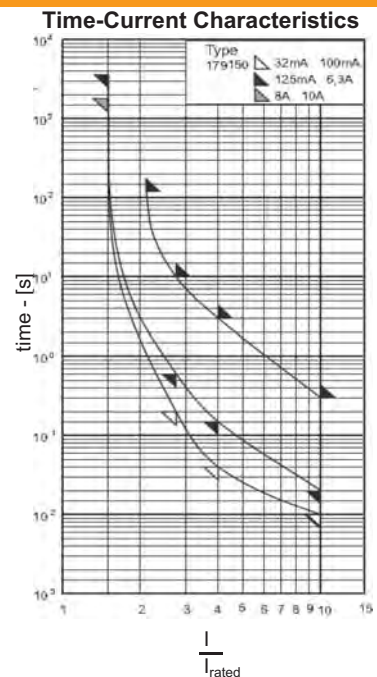
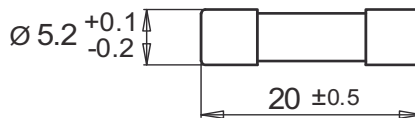

Rated Current	Fusing Time Limits									
	1.5I _n		2.1I _n		2.75I _n		4I _n		10I _n	
	Min	Max	Min	Max	Min	Max	Min	Max	Min	Max
32mA - 100mA	1h	—	—	2m	200ms	10s	40ms	3s	10ms	300ms
125mA - 6.3A	1h	—	—	2m	600ms	10s	150ms	3s	20ms	300ms
8A - 100A	30m	—	—	2m	600ms	10s	150ms	3s	20ms	300ms

G **Rated Voltage** [Un] 250V_{AC} **Rated Breaking Test** Voltage 250V_{AC} Capacity 1.5kA **Class** T **Standard(s)** IEC 60127-2/5 EN 60127-2/5 VDE 0820 - 2/5

5mmx20mm - Ceramic Tube w/Filler, Contacts - Brass, Nickel Plated

Rated Current I _n [A]	Article Number	UL rec	Rated Breaking Current [A]	Voltage Drop [mV]	Power Dissipation @ 1.5I _n [W]	Pre-arcing I ² t [A ² s]	Approvals
0.050	179200.0.050	✓	1.5kA @ 250V _{AC} ¹	1 500	0.2	0.02	S - Semko V - VDE
0.063	179200.0.063	✓	1.5kA @ 250V _{AC} ¹	1 000	0.2	0.05	
0.080	179200.0.080	✓	1.5kA @ 250V _{AC} ¹	2 800	0.6	0.02	
0.100	179200.0.100	✓	1.5kA @ 250V _{AC} ¹	2 300	0.6	0.02	
0.125	179200.0.125	✓	1.5kA @ 250V _{AC} ¹	2 200	0.8	0.045	
0.160	179200.0.160	✓	1.5kA @ 250V _{AC} ¹	2 100	0.9	0.08	
0.200	179200.0.200	✓	1.5kA @ 250V _{AC} ¹	1 800	0.9	0.14	
0.250	179200.0.250	✓	1.5kA @ 250V _{AC} ¹	1 500	1.0	0.25	
0.315	179200.0.315	✓	1.5kA @ 250V _{AC} ¹	1 000	1.0	0.45	
0.400	179200.0.400	✓	1.5kA @ 250V _{AC} ¹	850	1.0	0.8	
0.500	179200.0.500	✓	1.5kA @ 250V _{AC} ¹	350	0.4	0.35	
0.630	179200.0.630	✓	1.5kA @ 250V _{AC} ¹	300	0.4	0.6	
0.800	179200.0.800	✓	1.5kA @ 250V _{AC} ¹	300	0.6	1.0	
1	179200.1 ³	✓	1.5kA @ 250V _{AC} ¹	250	0.8	1.5	S V
1.25	179200.1.25 ³	✓	1.5kA @ 250V _{AC} ¹	200	0.8	3.1	S V
1.6	179200.1.6 ³	✓	1.5kA @ 250V _{AC} ¹	150	0.8	6.1	S V
2	179200.2 ³	✓	1.5kA @ 250V _{AC} ¹	130	0.8	5.2	S V
2.5	179200.2.5 ³	✓	1.5kA @ 250V _{AC} ¹	110	0.9	10	S V
3.15	179200.3.15 ³	✓	1.5kA @ 250V _{AC} ¹	100	1.0	20	S V
4	179200.4 ³	✓	1.5kA @ 250V _{AC} ¹	90	1.1	37	S V
5	179200.5	✓	1.5kA @ 250V _{AC} ¹	90	1.3	72	S V
6.3	179200.6.3	✓	1.5kA @ 250V _{AC} ¹	90	1.6	130	S V
8	179200.8	✓	1.5kA @ 250V _{AC} ¹	90	2.0	230	
10	179120.10	✓	1.5kA @ 250V _{AC} ¹	90	2.5	370	
12.5	179200.12.5		1.5kA @ 250V _{AC}	70	3.1	630	
16	179200.16		1.5kA @ 250V _{AC}	70	3.9	1 500	

Weight (kg per 100) ³⁾	UL Rec. 1.5kA@300V _{DC} , L/R = Res - 1A - 10A
0.14	¹⁾ cosφ = 0.7 - 0.8
Units per Package	
10	



Dimensions [mm]



FC - 1 000 pieces with color code
 AK - with assembled leaded caps
 IP - (1 000 pieces)
 e.g. 179200.3.15IP

Time-Current Characteristics

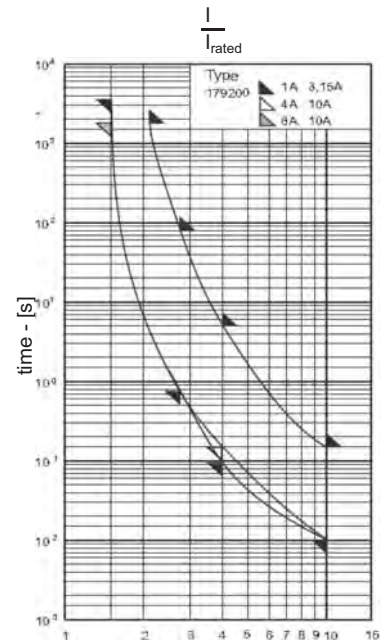
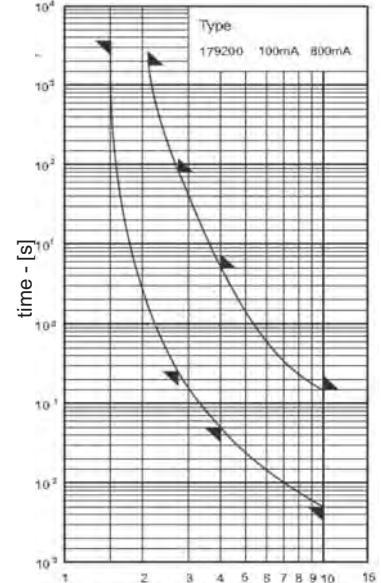

Rated Current	Fusing Time Limits									
	1.5I _n		2.1I _n		2.75I _n		4I _n		10I _n	
	Min	Max	Min	Max	Min	Max	Min	Max	Min	Max
100mA - 800mA	1h	—	—	30m	200ms	80s	50ms	5s	5s	150ms
1A - 3.15A	1h	—	—	30m	750ms	80s	95ms	5s	10ms	150ms
4A - 6.3A	1h	—	—	30m	750ms	80s	150ms	5s	10ms	150ms
8A - 16A	30m	—	—	30m	750ms	80s	150ms	5s	10ms	150ms

G

Rated Voltage
[Un]
250V_{AC}

Rated Breaking Test
Voltage Capacity
250V_{AC} 35A

Class
T

Standard(s)
IEC 60127-2/5
EN 60127-2/5
VDE 0820 - 2/5

5mmx20mm - Ceramic Tube w/Filler, Contacts - Brass, Gold Plated

Rated Current I_n [A]	Article Number	UL rec	Rated Breaking Current [A]	Voltage Drop [mV]	Power Dissipation @ 1.5 I_n [W]	Pre-arcing i^2t [A ² s]
1	179200.1SMD	✓	1.5kA @ 250V _{AC} ¹	250	0.8	1.5
1.25	179200.1.25SMD	✓	1.5kA @ 250V _{AC} ¹	200	0.8	3.1
1.6	179200.1.6SMD	✓	1.5kA @ 250V _{AC} ¹	150	0.8	6.1
2	179200.2SMD	✓	1.5kA @ 250V _{AC} ¹	130	0.8	5.2
2.5	179200.2.5SMD	✓	1.5kA @ 250V _{AC} ¹	110	0.9	10
3.15	179200.3.15SMD	✓	1.5kA @ 250V _{AC} ¹	100	1.0	20
4	179200.4SMD	✓	1.5kA @ 250V _{AC} ¹	90	1.1	37
5	179200.5SMD	✓	1.5kA @ 250V _{AC} ¹	90	1.3	72
6.3	179200.6.3SMD	✓	1.5kA @ 250V _{AC} ¹	90	1.6	130

Weight (kg per 100) ¹⁾ cosφ = 0.7 - 0.8

Units per Package

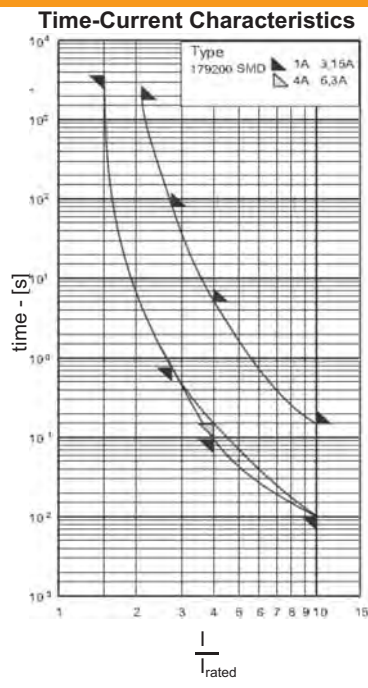

Dimensions
[mm]

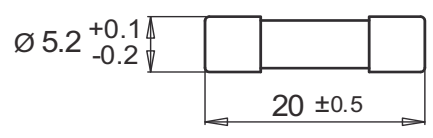

Rated Current	Fusing Time Limits									
	1.5 I_n		2.1 I_n		2.75 I_n		4 I_n		10 I_n	
	Min	Max	Min	Max	Min	Max	Min	Max	Min	Max
1A - 3.15A	1h	—	—	30m	750ms	80s	95ms	5s	10ms	150ms
4A - 6.3A	1h	—	—	30m	750ms	80s	150ms	5s	10ms	150ms

G

Rated Voltage [Un] 250V _{AC}	Rated Breaking Test Voltage 250V _{AC}	Capacity 300A	Class T
--	---	-------------------------	-------------------

Standard(s)
DIN 41571-3

5mmx20mm - Glass Tube w/Filler, Contacts - Brass, Nickel Plated

Rated Current I_n [A]	Article Number	Rated Breaking Current [A]	Voltage Drop [mV]	Power Dissipation @ 1.5 I_n [W]	Pre-arcing I^2t [A ² s]	Approvals
1.6	173100.1.6	300A @ 250Vac	300 ¹	0.8	16	
2	173100.2	300A @ 250Vac	190 ¹	0.9	26	
2.5	173100.2.5	300A @ 250Vac	180 ¹	1.1	45	
3.15	173100.3.15	300A @ 250Vac	140	1.3	72	
4	173100.4	300A @ 250Vac	135	1.4	130	
5	173100.5	300A @ 250Vac	130	1.2	150	
6.3	173100.6.3	300A @ 250Vac	125	1.3	240	
8	173100.8	300A @ 250Vac	120	1.6	390	
10	179120.10	300A @ 250Vac	115	1.9	620	
12.5	173100.12.5	300A @ 250V _{AC}	100	2.8	1 150	
15	173100.15	300A @ 250Vac	80	3.3	1 800	
16	173100.16	300A @ 250V _{AC}	80	3.8	1 800	

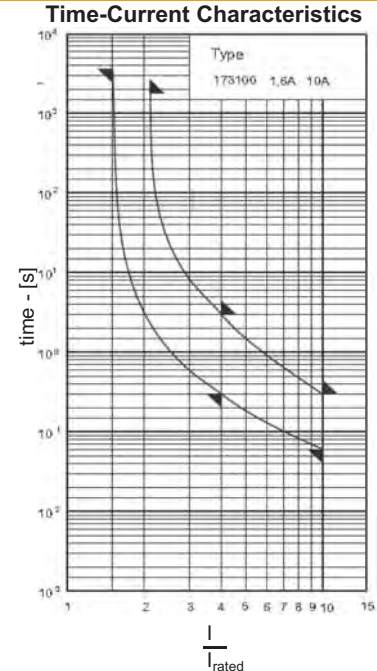

Weight (kg per 100)
0.13
Units per Package
100

¹⁾ Maximum according to EN 60127-2/5

IP - (1 000 pieces)
e.g. 173100.1.6IP



Dimensions
[mm]

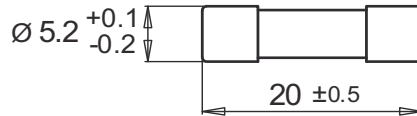

Rated Current	Fusing Time Limits									
	1.5 I_n		2.1 I_n		2.75 I_n		4 I_n		10 I_n	
	Min	Max	Min	Max	Min	Max	Min	Max	Min	Max
1.6A - 16A	1h	—	—	30m	—	—	300ms	3s	60ms	300ms

G

E167295

Rated Voltage
[Un]
250V_{AC}

Rated Breaking Test
Voltage
250V_{AC}

Capacity
35A / 100A

Class
T/D

Standard(s)
UL 248-14
CSA C22.2 -
No 248.14

5mmx20mm - Glass Tube, Contacts - Brass, Nickel Plated

Rated Current I_n [A]	Article Number	UL	Rated Breaking Current [A]	Voltage Drop [mV]	Power Dissipation @ 1.0I _n [W]	Pre-arcing I ² t [A ² s]	Approvals
0.080	179500.0.080	✓	35A @ 250V _{AC} ¹	2 800	0.3	0.024	
0.100	179500.0.100	✓	35A @ 250V _{AC} ¹	2 400	0.3	0.053	
0.125	179500.0.125	✓	35A @ 250V _{AC} ¹	2 100	0.3	0.08	
0.150	179500.0.150	✓	35A @ 250V _{AC} ¹	1 800	0.3	0.13	
0.200	179500.0.200	✓	35A @ 250V _{AC} ¹	1 300	0.3	0.24	
0.250	179500.0.250	✓	35A @ 250V _{AC} ¹	1 100	0.3	0.42	
0.300	179500.0.300	✓	35A @ 250V _{AC} ¹	1 050	0.4	0.8	
0.375	179500.0.375	✓	35A @ 250V _{AC} ¹	900	0.4	1.5	
0.400	179500.0.400	✓	35A @ 250V _{AC} ¹	850	0.4	1.6	
0.500	179500.0.500	✓	35A @ 250V _{AC} ¹	650	0.4	2.0	
0.630	179500.0.630	✓	35A @ 250V _{AC} ¹	550	0.4	3.1	
0.700	179500.0.700	✓	35A @ 250V _{AC} ¹	500	0.4	4.5	
0.750	179500.0.750	✓	35A @ 250V _{AC} ¹	450	0.4	5.5	
0.800	179500.0.800	✓	35A @ 250V _{AC} ¹	400	0.4	6.4	
1	179500.1	✓	35A @ 250V _{AC} ¹	350	0.4	12	
1.25	179500.1.25	✓	100A @ 250V _{AC} ²	300	0.4	19	
1.5	179500.1.5	✓	100A @ 250V _{AC} ²	280	0.5	25	
1.6	179500.1.6	✓	100A @ 250V _{AC} ²	270	0.5	32	
2	179500.2	✓	100A @ 250V _{AC} ²	235	0.5	55	
2.5	179500.2.5	✓	100A @ 250V _{AC} ²	215	0.6	90	
3	179500.3	✓	100A @ 250V _{AC} ²	200	0.6	160	

Weight (kg per 100)	1) 10kA@125V _{AC} , 35A@250V _{AC} - cosφ = 0.7 -0.8
0.1	2) 10kA@125V _{AC} , 100A@250V _{AC} - cosφ = 0.7 -0.8
Units per Package	
10	

IP - (1 000 pieces)
e.g. 179500.1.6IP



Dimensions
[mm]

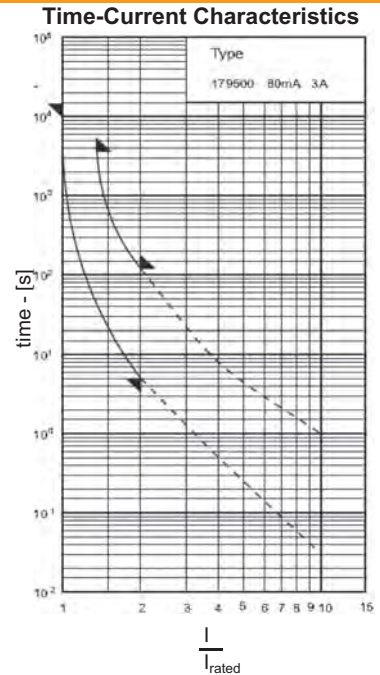
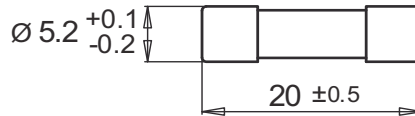

Rated Current	Fusing Time Limits									
	1.0I _n		1.35I _n		2.0I _n					
	Min	Max	Min	Max	Min	Max	Min	Max	Min	Max
80mA - 3A	4h	—	—	1h	5s	120s	—	—	—	—

G

RoHS

Rated Voltage
 [Un]
 250V_{AC}

Rated Breaking Test
 Voltage
 250V_{AC}

Capacity
 35A / 10 I_{rat}

Class
 TT

Standard(s)

5mmx20mm - Glass Tube, Contacts - Brass, Nickel Plated

Rated Current I _n [A]	Article Number	Rated Breaking Current [A]	Voltage Drop [mV]	Power Dissipation @ 1.0I _n [W]	Pre-arcing I ² t [A ² s]	Approvals
0.400	190000.0.400	35A @ 250V _{AC}	500	0.3	2.5	
0.500	190000.0.500	35A @ 250V _{AC}	450	0.3	4.6	
0.630	190000.0.630	35A @ 250V _{AC}	400	0.3	10	
0.800	190000.0.800	35A @ 250V _{AC}	300	0.4	15	
1	190000.1	35A @ 250V _{AC}	250	0.4	26	
1.25	190000.1.25	35A @ 250V _{AC}	200	0.4	37	
1.6	190000.1.6	35A @ 250V _{AC}	200	0.5	45	
2	190000.2	35A @ 250V _{AC}	200	0.6	72	
2.5	190000.2.5	35A @ 250V _{AC}	150	0.6	130	
3.15	190000.3.15	35A @ 250V _{AC}	150	0.6	230	
4	190000.4	40A @ 250V _{AC}	100	0.8	370	

Weight (kg per 100)
0.1
Units per Package
10

IP - (1 000 pieces)
e.g. 190000.2IP

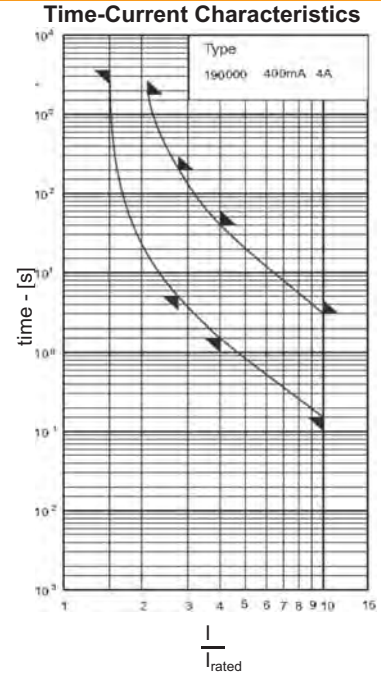

Dimensions
[mm]

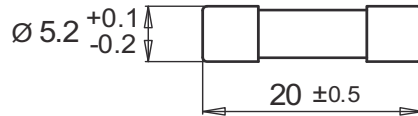

Rated Current	Fusing Time Limits									
	1.5I _n		2.1I _n		2.75I _n		4I _n		10I _n	
	Min	Max	Min	Max	Min	Max	Min	Max	Min	Max
400mA - 4A	1h	—	—	30m	5s	200s	1.5s	40s	150ms	3s

G **Rated Voltage** **Rated Breaking Test** **Class** **Standard(s)**

[Un]
250V_{AC} **Voltage**
250V_{AC} **Capacity**
50A / 80A

F & M

5mmx25mm - Glass Tube w/Filler, Contacts - Brass, Nickel Plated

Rated Current <i>I_n</i> [A]	F		M		Rated Breaking Current [A]	Approvals
	Article Number		Article Number			
without filling						
0.032	171525.0.032		172525.0.032		50A @ 250V _{AC}	
0.050	171525.0.050		172525.0.050		50A @ 250V _{AC}	
0.063	171525.0.063		172525.0.063		50A @ 250V _{AC}	
0.080	171525.0.080		172525.0.080		50A @ 250V _{AC}	
0.100	171525.0.100		172525.0.100		50A @ 250V _{AC}	
0.125	171525.0.125		172525.0.125		50A @ 250V _{AC}	
0.160	171525.0.160		172525.0.160		50A @ 250V _{AC}	
0.200	171525.0.200		172525.0.200		50A @ 250V _{AC}	
0.250	171525.0.250		172525.0.250		50A @ 250V _{AC}	
0.315	171525.0.315		172525.0.315		50A @ 250V _{AC}	
0.400	171525.0.400		172525.0.400		50A @ 250V _{AC}	
0.500	171525.0.500		172525.0.500		50A @ 250V _{AC}	
0.630	171525.0.630		172525.0.630		50A @ 250V _{AC}	
0.800	171525.0.800		172525.0.800		50A @ 250V _{AC}	
1	171525.1		172525.1		50A @ 250V _{AC}	
1.25	171525.1.25		172525.1.25		50A @ 250V _{AC}	
with filling						
1.6	171525.1.6		172525.1.6		80A @ 250V _{AC}	
2	171525.2		172525.2		80A @ 250V _{AC}	
2.5	171525.2.5		172525.2.5		80A @ 250V _{AC}	
3.15	171525.3.15		172525.3.15		80A @ 250V _{AC}	
4	171525.4		172525.4		80A @ 250V _{AC}	
5	171525.5		172525.5		80A @ 250V _{AC}	
6.3	171525.6.3		172525.6.3		80A @ 250V _{AC}	
8	171525.8		172525.8		80A @ 250V _{AC}	
10	171525.10		171525.10		80A @ 250V _{AC}	

Weight (kg per 100)	
0.12	0.15
Units per Package	
10	



Dimensions [mm]

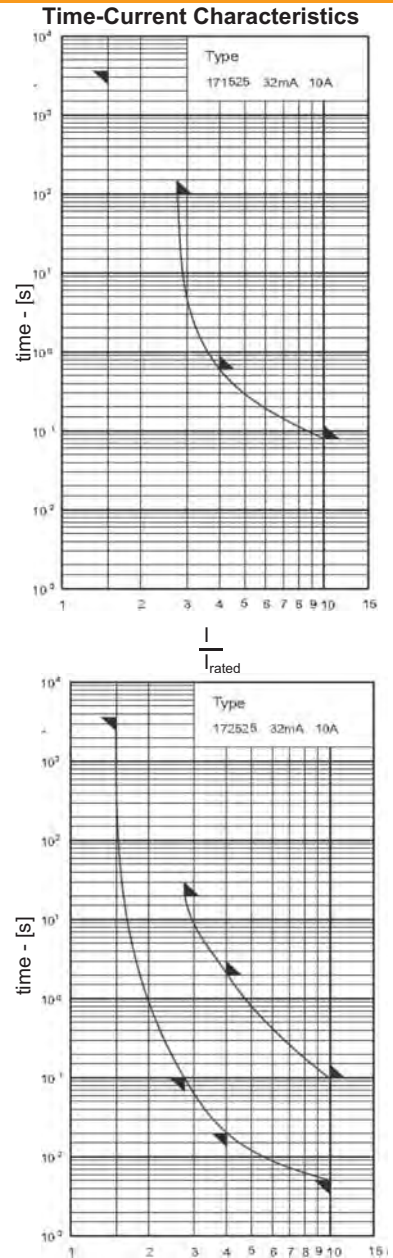
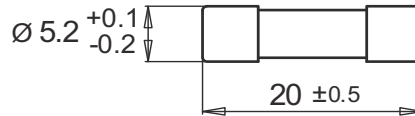

	Rated Current	Fusing Time Limits									
		1.5I _n		2.1I _n		2.75I _n		4I _n		10I _n	
		Min	Max	Min	Max	Min	Max	Min	Max	Min	Max
171525	32mA - 10A	1h	—	—	—	—	100s	—	600ms	—	80ms
172525	32mA - 10A	1h	—	—	—	100s	20s	2s	40s	5ms	100ms

G Rated Voltage Rated Breaking Test Class Standard(s)

RoHS
[Un]
60V_{AC}
Voltage
60V_{AC}
Capacity
1.5kA

DIN 41572

10mmx51mm - Glass Tube, Contacts - Brass, Nickel Plated

Rated Current I_n [A]	Article Number	Rated Breaking Current [A]	Voltage Drop [mV]	Power Dissipation [W]	Pre-arcing I^2t [A ² s]	Approvals
0.500	7001908.0.500	1.5kA @ 60Vac	1 500		0.16	
0.800	7001908.0.800	1.5kA @ 60Vac	1 200		0.8	
1	7001908.1	1.5kA @ 60Vac	1 000		0.64	
1.6	7001908.1.6	1.5kA @ 60Vac	1 120		2.6	
2	7001908.2	1.5kA @ 60Vac	1 200		4.9	
2.5	7001908.2.5	1.5kA @ 60Vac	1 000		10	
3	7001908.3	1.5kA @ 60Vac	900		19	
4	7001908.4	1.5kA @ 60Vac	800		41	
6	7001908.6	1.5kA @ 60Vac	600		140	

Weight (kg per 100)
Units per Package

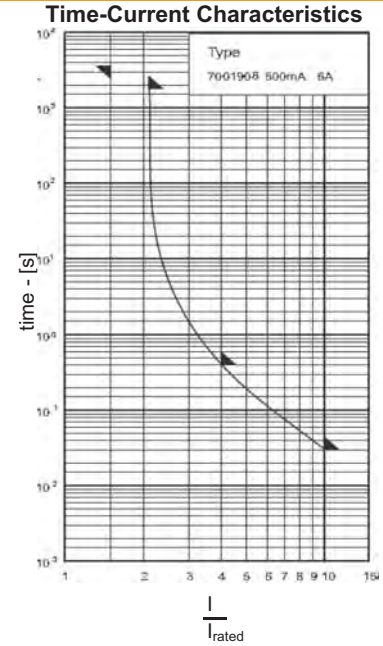

Dimensions [mm]

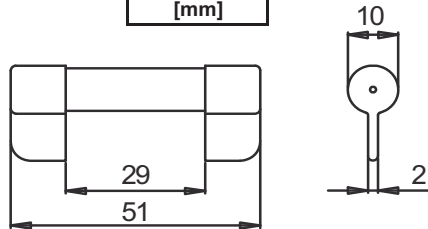

Rated Current	Fusing Time Limits									
	1.5I _n		2.1I _n		2.75I _n		5I _n		10I _n	
	Min	Max	Min	Max	Min	Max	Min	Max	Min	Max
500mA - 6A	1h	—	—	30m	—	100s	—	400ms	—	30ms

G **Rated Voltage** **Rated Breaking Test** **Class** **Standard(s)**

[Un]
250V_{AC} **Voltage**
250V_{AC} **Capacity**
1.5kA

5mmx25mm - Ceramic Tube w/Filler, Contacts - Brass, Nickel Plated

Rated Current I_n [A]	Article Number	Rated Breaking Current [A]	Voltage Drop [mV]	Power Dissipation @ 1.5 I_n [W]	Pre-arcing I^2t [A ² s]	Color Code
1.6	171526.1.6	1.5kA @ 250V _{AC}	640	0.9	2.3	Orange
2	171526.2	1.5kA @ 250V _{AC}	420	1.1	2.4	Blue
2.5	171526.2.5	1.5kA @ 250V _{AC}	320	1.2	4	Yellow
3.15	171526.3.15	1.5kA @ 250V _{AC}	250	1.4	6.5	Black
4	171526.4	1.5kA @ 250V _{AC}	200	1.7	16	Brown
5	171526.5	1.5kA @ 250V _{AC}	180	2.1	33	White
6.3	171526.6.3	1.5kA @ 250V _{AC}	170	2.5	63	Green
8	171526.8	1.5kA @ 250V _{AC}	150	3.0	100	Grey
10	171526.10	1.5kA @ 250V _{AC}	120	3.3	200	Red
Weight (kg per 100)						
0.13						
Units per Package						
10						

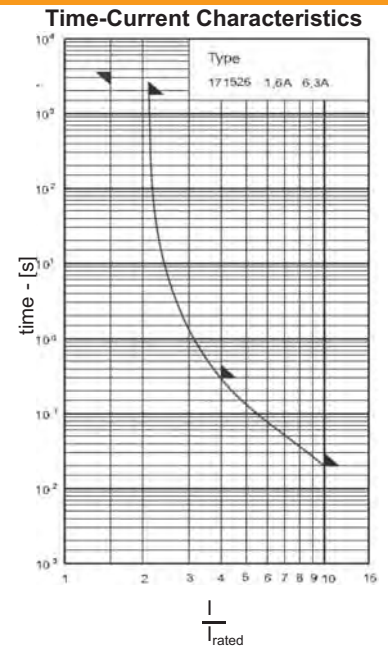

Dimensions [mm]



Rated Current	Fusing Time Limits									
	1.5 I_n		2.1 I_n		2.75 I_n		4 I_n		10 I_n	
	Min	Max	Min	Max	Min	Max	Min	Max	Min	Max
1.6A - 10A	1h	—	—	30m	—	—	—	400ms	—	20ms

G Rated Voltage Rated Breaking Test Class Standard(s)

RoHS
[Un]
250V_{AC}
Voltage
250V_{AC}
Capacity
80A / 1.5kA
M
DIN 41576-2

5mmx25mm - Ceramic Tube w/Filler, Contacts - Brass, Nickel Plated

Rated Current I_n [A]	Article Number	Rated Breaking Current [A]	Voltage Drop [mV]	Power Dissipation @ 1.5I _n [W]	Pre-arcing I ² t [A ² s]	Color Code
without filler						
0.050	172526.0.050	80A @ 250V _{AC}	520	0.1	0.005	White
0.063	172526.0.063	80A @ 250V _{AC}	520	0.1	0.007	Green
0.080	172526.0.080	80A @ 250V _{AC}	520	0.1	0.009	Grey
0.100	172526.0.100	80A @ 250V _{AC}	500	0.1	0.022	Red
0.125	172526.0.125	80A @ 250V _{AC}	500	0.1	0.041	Violet
0.160	172526.0.160	80A @ 250V _{AC}	400	0.1	0.1	Orange
0.200	172526.0.200	80A @ 250V _{AC}	400	0.2	0.2	Blue
0.250	172526.0.250	1.5kA @ 250V _{AC}	375	0.2	0.22	Yellow
0.315	172526.0.315	1.5kA @ 250V _{AC}	410	0.2	0.31	Black
0.400	172526.0.400	1.5kA @ 250V _{AC}	280	0.2	0.56	Brown
0.500	172526.0.500	1.5kA @ 250V _{AC}	250	0.2	1.1	White
0.630	172526.0.630	1.5kA @ 250V _{AC}	220	0.2	0.7	Green
0.800	172526.0.800	1.5kA @ 250V _{AC}	400	0.2	1.6	Grey
1	172526.1	1.5kA @ 250V _{AC}	350	0.2	3.5	Red
1.25	172526.1.25	1.5kA @ 250V _{AC}	315	0.4	5.5	Violet
with filler						
1.6	172526.1.6	1.5kA @ 250V _{AC}	480	0.6	5.6	Orange
2	172526.2	1.5kA @ 250V _{AC}	360	0.7	9.6	Blue
2.5	172526.2.5	1.5kA @ 250V _{AC}	300	0.9	15	Yellow
3.15	172526.3.15	1.5kA @ 250V _{AC}	250	1.1	24	Black
4	172526.4	1.5kA @ 250V _{AC}	180	1.3	40	Brown
5	172526.5	1.5kA @ 250V _{AC}	180	1.5	87	White
6.3	172526.6.3	1.5kA @ 250V _{AC}	160	1.8	170	Green
8	172526.8	1.5kA @ 250V _{AC}	150	3	190	Grey
10	172526.10	1.5kA @ 250V _{AC}	150	3.2	370	Red

Weight (kg per 100)
0.15
Units per Package
10



Dimensions [mm]

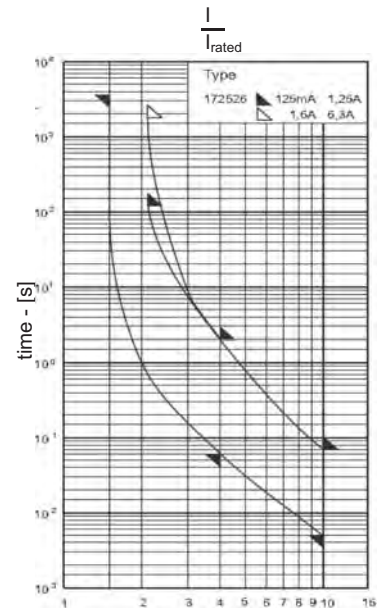
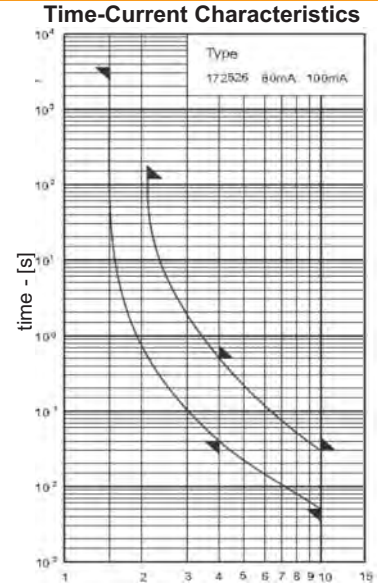

Rated Current	Fusing Time Limits									
	1.5I _n		2.1I _n		2.75I _n		5I _n		10I _n	
	Min	Max	Min	Max	Min	Max	Min	Max	Min	Max
1.6A - 6.3A	1h	—	—	2m	—	—	40s	500ms	5ms	30ms
1.6A - 6.3A	1h	—	—	3m	—	—	60ms	2s	5ms	70ms
1.6A - 6.3A	1h	—	—	30m	—	—	60ms	2s	5ms	70ms

G **Rated Voltage** [Un] **Rated Breaking Test** **Class** **Standard(s)**

400V_{AC} **500V_{AC}** **F** **Lloyds approved**

70kA

5mmx25mm - Ceramic Tube w/Indicator, Contacts - Brass, Nickel Plated

Rated Current I _n [A]	Article Number	Rated Breaking Current [A]	Voltage Drop [mV]	Power Dissipation @ 1.5I _n [W]	Pre-arcing I ² t [A ² s]	Color Code
0.250	7008913.0.250	70kA @ 500V _{AC} ¹	950	0.3	0.05	Yellow
0.315	7008913.0.315	70kA @ 500V _{AC} ¹	900	0.5	0.05	Black
0.400	7008913.0.400	70kA @ 500V _{AC} ¹	800	0.5	0.15	Brown
0.500	7008913.0.500	70kA @ 500V _{AC} ¹	700	0.6	0.15	White
0.800	7008913.0.800	70kA @ 500V _{AC} ¹	300	0.3	0.25	Grey
1	7008913.1	70kA @ 500V _{AC} ¹	250	0.3	0.5	Red
1.25	7008913.1.25	70kA @ 500V _{AC} ¹	400	0.4	1.1	Violet
1.6	7008913.1.6	70kA @ 500V _{AC} ¹	400	0.9	2.3	Orange
2	7008913.2	70kA @ 500V _{AC} ¹	350	1.1	2.4	Blue
2.5	7008913.2.5	70kA @ 500V _{AC} ¹	300	1.2	4	Yellow
3.15	7008913.3.15	70kA @ 500V _{AC} ¹	200	1.4	6.5	Black
4	7008913.4	70kA @ 500V _{AC} ¹	200	1.7	16	Brown
5	7008913.5	70kA @ 500V _{AC} ¹	200	2.1	33	White
6.3	7008913.6.3	70kA @ 500V _{AC} ¹	150	2.5	63	Green
8	70089 3.8	70kA @ 500V _{AC} ¹	150	3.0	100	Grey
10	7008913.10	70kA @ 500V _{AC} ¹	150	3.3	200	Red
Weight (kg per 100)		1) 10kA @ 250V _{DC}				
0.13						
Units per Package						
10						

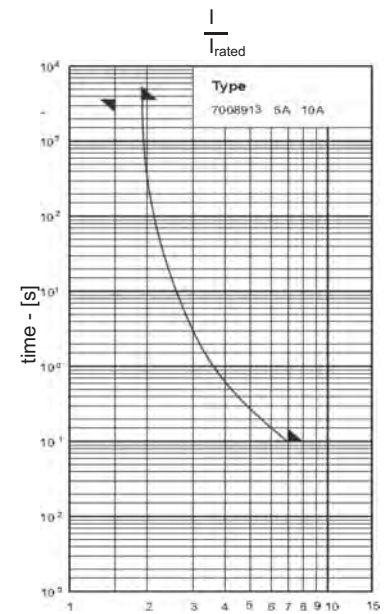
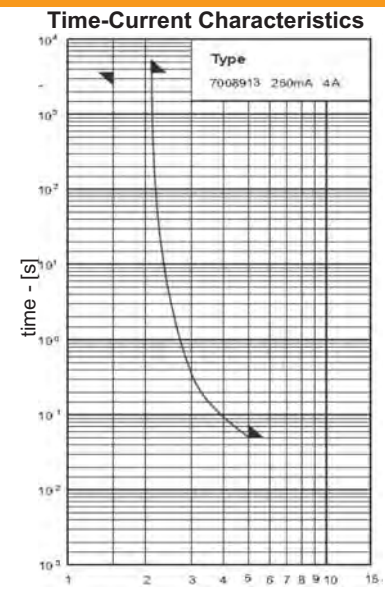

Dimensions [mm]

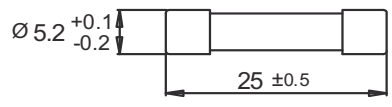

Rated Current	Fusing Time Limits									
	1.5I _n		1.9I _n		2.1I _n		5I _n		7I _n	
	Min	Max	Min	Max	Min	Max	Min	Max	Min	Max
500mA - 4A	1h	—	—	—	—	—	1h	—	50ms	—
5A - 10A	1h	—	—	1h	—	—	—	—	—	100ms

G

RoHS

Rated Voltage [Un] 250V _{AC}	Rated Breaking Test Voltage 250V _{AC}	Capacity 80A / 1.5kA	Class M
--	---	--------------------------------	-------------------

Standard(s)
DIN 41577 T.2

5mmx"L"mm - Ceramic Tube w/Indicator, Contacts - Brass, Nickel Plated

Rated Current I_n [A]	Article Number	Rated Breaking Current [A]	Voltage Drop [mV]	Power Dissipation @ 1.5I _n [mw]	Pre-arcing I ² t [A ² s]	Length "L" [mm]
0.080	7001607.0.080	80A @ 250V _{AC}	520	0.1	0.017	25
0.100	7001607.0.100	80A @ 250V _{AC}	500	0.1	0.022	
0.125	7001607.0.125	80A @ 250V _{AC}	500	0.1	0.041	
0.160	7001607.0.160	80A @ 250V _{AC}	400	0.1	0.1	
0.200	7001607.0.200	80A @ 250V _{AC}	400	0.2	0.2	
0.250	7001707.0.250	1.5kA @ 250V _{AC}	500	0.2	0.22	25
0.315	7001707.0.315	1.5kA @ 250V _{AC}	470	0.2	0.31	
0.400	7001707.0.400	1.5kA @ 250V _{AC}	400	0.2	0.56	
0.500	7001707.0.500	1.5kA @ 250V _{AC}	400	0.2	1.1	
0.630	7001707.0.630	1.5kA @ 250V _{AC}	380	0.2	0.7	
0.8	7001407.0.800	1.5kA @ 250V _{AC}	400	0.3	1.6	20
1	7001407.1	1.5kA @ 250V _{AC}	350	0.3	3.5	
1.25	7001407.1.25	1.5kA @ 250V _{AC}	310	0.3	5.5	
1.6	7001407.1.6	1.5kA @ 250V _{AC}	480	1.0	5.6	
2	7001407.2	1.5kA @ 250V _{AC}	360	1.0	9.6	
2.5	7001407.2.5	1.5kA @ 250V _{AC}	300	1.1	15	
3.15	7001407.3.15	1.5kA @ 250V _{AC}	250	1.2	24	
4	7001407.4	1.5kA @ 250V _{AC}	180	1.3	40	
6.3	7001205.6.3	1.5kA @ 250V _{AC}	160	1.8	170	

Weight (kg per 100)
0.15
Units per Package
10

Dimensions
[mm]

7001607 / 7001707

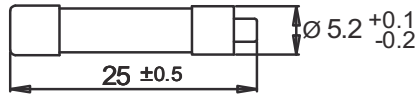

7001407

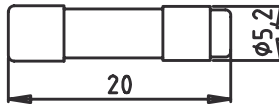

7001205

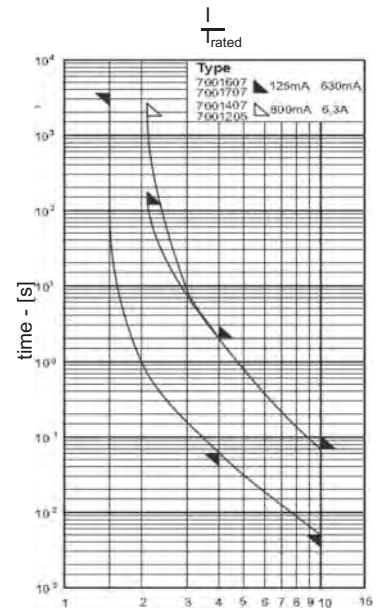
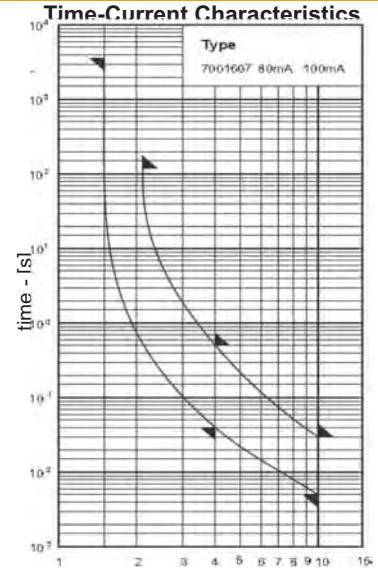
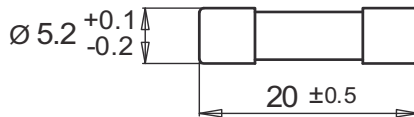

Rated Current	Fusing Time Limits									
	1.5I _n		2.1I _n		2.75I _n		4I _n		10I _n	
	Min	Max	Min	Max	Min	Max	Min	Max	Min	Max
80mA - 100mA	1h	—	—	2m	—	—	40ms	500ms	5ms	30ms
125mA - 630mA	1h	—	—	2m	—	—	60ms	2s	5ms	70ms
800mA - 6.3A	1h	—	—	30m	—	—	60ms	2s	5ms	70ms

G RoHS Rated Voltage [Un] 500V_{AC} Rated Breaking Test Voltage 500V_{AC} Capacity 50A Class F/M Standard(s)

5mmx30mm - Glass Tube w/Filler, Contacts - Brass, Nickel Plated

Rated Current I _n [A]	F		M		Rated Breaking Current [A]
	Article Number		Article Number		
without filling					
0.032	171530.0.032		172530.0.032		50A @ 500V _{AC}
0.050	171530.0.050		172530.0.050		50A @ 500V _{AC}
0.063	171530.0.063		172530.0.063		50A @ 500V _{AC}
0.080	171530.0.080		172530.0.080		50A @ 500V _{AC}
0.100	171530.0.100		172530.0.100		50A @ 500V _{AC}
0.125	171530.0.125		172530.0.125		50A @ 500V _{AC}
0.160	171530.0.160		172530.0.160		50A @ 500V _{AC}
0.200	171530.0.200		172530.0.200		50A @ 500V _{AC}
0.250	171530.0.250		172530.0.250		50A @ 500V _{AC}
0.315	171530.0.315		172530.0.315		50A @ 500V _{AC}
0.400	171530.0.400		172530.0.400		50A @ 500V _{AC}
0.500	171530.0.500		172530.0.500		50A @ 500V _{AC}
0.630	171530.0.630		172530.0.630		50A @ 500V _{AC}
0.800	171530.0.800		172530.0.800		50A @ 500V _{AC}
1	171530.1		172530.1		50A @ 500V _{AC}
1.25	171530.1.25		172530.1.25		50A @ 500V _{AC}
with filling					
1.6	171530.1.6		172530.1.6		80A @ 500V _{AC}
2	171530.2		172530.2		80A @ 500V _{AC}
2.5	171530.2.5		172530.2.5		80A @ 500V _{AC}
3.15	171530.3.15		172530.3.15		80A @ 500V _{AC}
4	171530.4		172530.4		80A @ 500V _{AC}
5	171530.5		172530.5		80A @ 500V _{AC}
6.3	171530.6.3		172530.6.3		80A @ 500V _{AC}
8	171530.8		172530.8		80A @ 500V _{AC}
10	171530.10		171530.10		80A @ 500V _{AC}

Weight (kg per 100)
0.12
Units per Package
10



Dimensions [mm]



Time-Current Characteristics

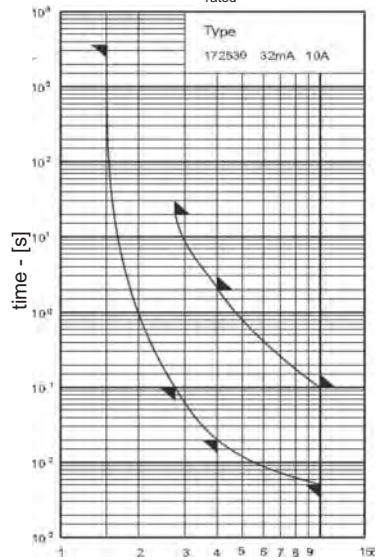
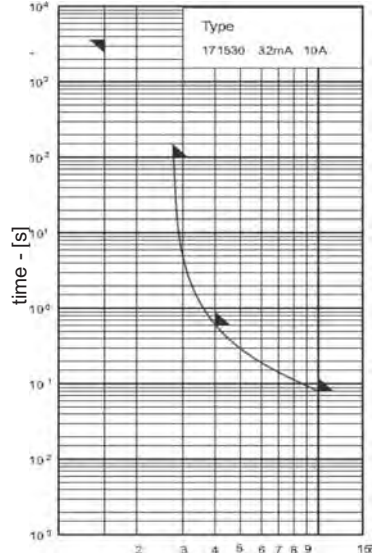

	Rated Current	Fusing Time Limits									
		1.5I _n		2.1I _n		2.75I _n		4I _n		10I _n	
		Min	Max	Min	Max	Min	Max	Min	Max	Min	Max
171530	32mA - 10A	1h	—	—	—	—	100ms	—	600ms	—	80ms
172530	32mA - 10A	1h	—	—	—	50ms	30s	20ms	2s	5ms	100ms

G **Rated Voltage** **Rated Breaking Test** **Class** **Standard(s)**



[Un]
700V_{AC}

Voltage
700V_{AC} Capacity
50kA



6.3mmx32mm - Ceramic Tube w/Filler, Contacts - Brass, Nickel Plated

Rated Current I_n [A]	Article Number		Rated Breaking Current [A]	Voltage Drop [mV]	Power Dissipation @ $1I_n/1.2I_n$ [W]	Pre-arcing I^2t [A ² s]
0.100	7012540.0.100	✓	50kA @ 700V _{AC} ¹	2 500	0.3	0.0009
0.125	7012540.0.125	✓	50kA @ 700V _{AC} ¹	2 200	0.3	0.0017
0.160	7012540.0.160	✓	50kA @ 700V _{AC} ¹	2 000	0.4	0.004
0.200	7012540.0.200	✓	50kA @ 700V _{AC} ¹	900	0.2	0.01
0.250	7012540.0.250	✓	50kA @ 700V _{AC} ¹	800	0.2	0.02
0.315	7012540.0.315	✓	50kA @ 700V _{AC} ¹	700	0.3	0.04
0.400	7012540.0.400	✓	50kA @ 700V _{AC} ¹	650	0.3	0.07
0.500	7012540.0.500	✓	50kA @ 700V _{AC} ¹	650	0.4	0.15
0.630	7012540.0.630	✓	50kA @ 700V _{AC} ¹	650	0.5	0.15
0.800	7012540.0.800	✓	50kA @ 700V _{AC} ¹	600	0.5	0.32
1	7012540.1	✓	50kA @ 700V _{AC} ¹	750	0.8	0.32
1.25	7012540.1.25	✓	50kA @ 700V _{AC} ¹	700	0.9	0.20
1.6	7012540.1.6	✓	50kA @ 700V _{AC} ¹	650	1.1	0.31
2	7012540.2	✓	50kA @ 700V _{AC} ¹	650	1.4	0.64
2.5	7012540.2.5	✓	50kA @ 600V _{AC}	550	1.4	1.2
3.15	7012540.3.15	✓	50kA @ 600V _{AC}	500	1.6	2.0
4	7012540.4	✓	50kA @ 600V _{AC}	450	1.8	5.0
5	7012540.5	✓	50kA @ 500V _{AC}	400	2.0	10
6.3	7012540.6.3	✓	50kA @ 600V _{AC}	400	4	3.0
8	7012540.8	✓	50kA @ 600V _{AC}	350	4.5	6.5
10	7012540.10	✓	50kA @ 600V _{AC}	350	5	12
12.5	7012540.12.5	✓	50kA @ 500V _{AC}	300	7	18
16	7012540.16	✓	50kA @ 500V _{AC}	300	9	31
20	7012540.20	✓	50kA @ 500V _{AC}	300	11	46
25	7012540.25		50kA @ 500V _{AC}	230	11	87

Time-Current Characteristics

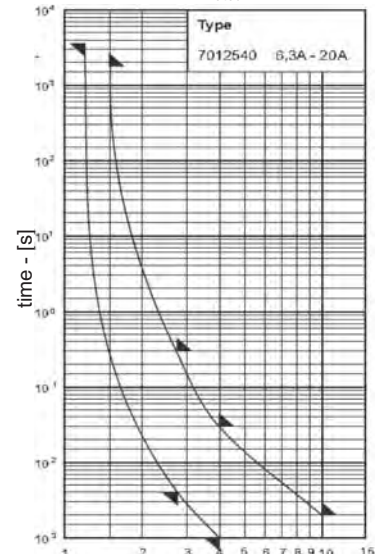
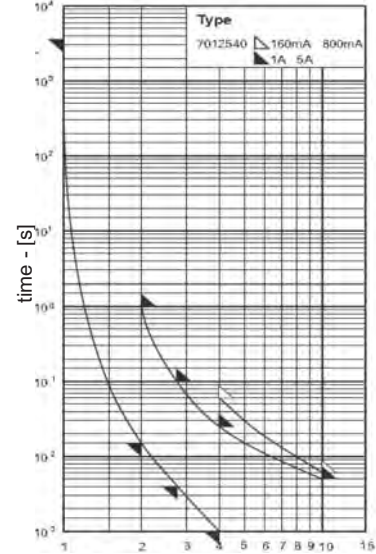

0	Weight (kg per 100)	¹⁾ 20kA @ 500V _{DC}
	0.24	
	Units per Package	
	10	

For 6.3A and higher, consideration should be given to heat dissipation



Dimensions
[mm]

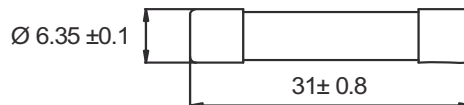

Rated Current	Fusing Time Limits									
	$1I_n$		$1.2I_n$		$2.75I_n$		$4I_n$		$10I_n$	
	Min	Max	Min	Max	Min	Max	Min	Max	Min	Max
160mA - 800mA	1h	—	—	—	—	—	—	60ms	—	6ms
1A - 5A	1h	—	—	—	4ms	150s	1ms	25ms	—	5ms
6.3A - 20A	—	—	1h	—	4ms	300s	1ms	30ms	—	2ms

IP - (1 000 pieces)
e.g. 70 125 40.16IP

SIBA LLC

29 Fairfield Place
West Caldwell, New Jersey 07006

e-mail: info@sibafuse.com
www.siba-fuses.us

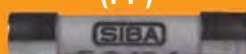
G  **Rated Voltage** **Rated Breaking Test** **Class** **Standard(s)**
[Un] **Voltage** **Capacity** **aR**
1000V_{AC} **1000V_{AC}** **30kA** **(FF)**
 E167295 
6.3mmx32mm - Ceramic Tube w/Filler, Contacts - Brass, Nickel Plated

Rated Current I_n [A]	Article Number	✓	Rated Breaking Current [A]	Voltage Drop [mV]	Power Dissipation @ 1.0 I_n [W]	Pre-arcing I^2t [A ² s]
0.100	7017240.0.100	✓	30kA @ 1000V _{AC/DC}	2 500	0.3	0.0009
0.125	7017240.0.125	✓	30kA @ 1000V _{AC/DC}	2 200	0.3	0.0017
0.160	7017240.0.160	✓	30kA @ 1000V _{AC/DC}	2 000	0.4	0.004
0.200	7017240.0.200	✓	30kA @ 1000V _{AC/DC}	900	0.2	0.01
0.250	7017240.0.250	✓	30kA @ 1000V _{AC/DC}	800	0.2	0.02
0.315	7017240.0.315	✓	30kA @ 1000V _{AC/DC}	700	0.3	0.04
0.400	7017240.0.400	✓	30kA @ 1000V _{AC/DC}	650	0.3	0.07
0.500	7017240.0.500	✓	30kA @ 1000V _{AC/DC}	650	0.4	0.12
0.630	7017240.0.630	✓	30kA @ 1000V _{AC/DC}	650	0.5	0.15
0.800	7017240.0.800	✓	30kA @ 1000V _{AC/DC}	600	0.5	0.23
1	7017240.1	✓	30kA @ 1000V _{AC/DC}	750	0.8	0.32
1.6	7017240.1.6	✓	30kA @ 1000V _{AC/DC}	650	1.1	0.31
2	7017240.2	✓	30kA @ 1000V _{DC}	650	1.4	0.64

Weight (kg per 100)
Units per Package

IP - (1 000 pieces)
e.g. 70 172 40.1.6IP

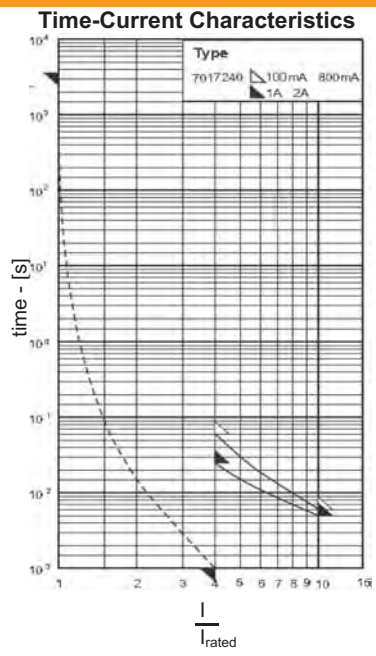

Dimensions
[mm]

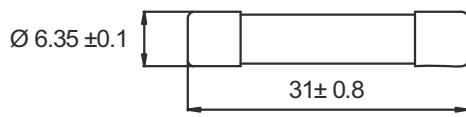

Rated Current	Fusing Time Limits									
	1 I_n		1.2 I_n		2.75 I_n		4 I_n		10 I_n	
	Min	Max	Min	Max	Min	Max	Min	Max	Min	Max
100mA - 800mA	1h	—	—	—	—	—	—	60ms	—	6ms
1A - 2A	1h	—	—	—	—	—	1ms	25ms	—	6ms



FUSES

G



Rated Voltage

[Un]
400V_{AC}

Rated Breaking Test

Voltage Capacity
400V_{AC} 120kA

Class

gRL

Standard(s)

IEC 60269-4
VDE 0636 Part4



6.3mmx32mm - Ceramic Tube w/Filler, Contacts - Brass, Nickel Plated

Rated Current I_n [A]	Article Number	UL rec	Rated Breaking Current [A]	Voltage Drop [mV]	Power Dissipation @ 1.0I _n [w]	Pre-arcing I ² t [A ² s]	Total I ² t [A ² s]
6.3	70065 4.6.3	✓	120kA @ 400V _{AC}	190	1.2	1.8	11
8	7006584.8	✓	120kA @ 400V _{AC}	190	1.5	3.0	18
10	7006584.10	✓	120kA @ 400V _{AC}	180	1.8	5.1	31
12.5	7006584.12.5	✓	120kA @ 400V _{AC}	150	1.9	12	69
16	7006584.16	✓	120kA @ 400V _{AC}	150	2.3	20	120
20	7006584.20	✓	120kA @ 400V _{AC}	160	3.2	35	210

Weight (kg per 100)
Units per Package

IP - (1 000 pieces)
e.g. 70 065 84.12.5IP

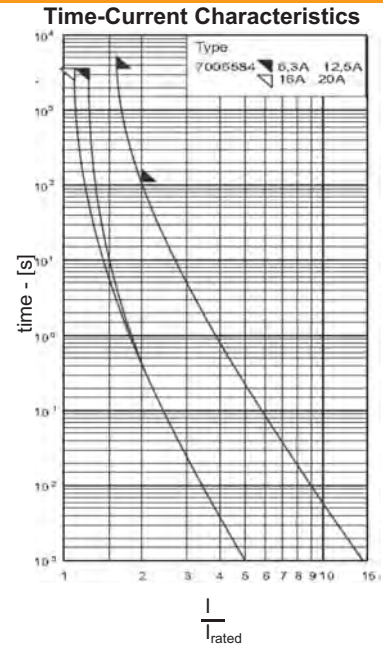

Dimensions
[mm]

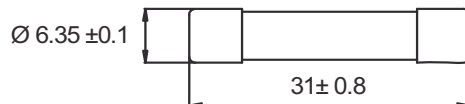

Rated Current	Fusing Time Limits									
	1.1I _n		1.25I _n		1.6I _n		2.0I _n		Min	Max
	Min	Max	Min	Max	Min	Max	Min	Max		
6.3A - 12.5A	—	—	1h	—	—	1h	—	120s	—	—
16A - 20A	1h	—	—	—	—	1h	1ms	120s	—	—

G RoHS **Rated Voltage** [Un] **Rated Breaking Test** **Class** **Standard(s)**

250V_{AC} Voltage Capacity 35A **F** IEC 60269-2/4

6.3mmx32mm - Glass Tube, Contacts - Brass, Nickel Plated

Rated Current I _n [A]	Article Number	Rated Breaking Current [A]	Voltage Drop [mV]	Power Dissipation @ 1.15I _n [W]	Pre-arcing I ² t [A ² s]
0.050	189000.0.050	35A @ 250V _{AC}	9 600	0.7	0.0003
0.063	189000.0.063	35A @ 250V _{AC}	6 000	0.5	0.0005
0.080	189000.0.080	35A @ 250V _{AC}	5 000	0.6	0.001
0.100	189000.0.100	35A @ 250V _{AC}	4 500	0.7	0.0014
0.125	189000.0.125	35A @ 250V _{AC}	4 000	0.7	0.0034
0.160	189000.0.160	35A @ 250V _{AC}	3 500	0.8	0.007
0.200	189000.0.200	35A @ 250V _{AC}	650	0.2	0.02
0.250	189000.0.250	35A @ 250V _{AC}	650	0.3	0.04
0.315	189000.0.315	35A @ 250V _{AC}	600	0.3	0.08
0.400	189000.0.400	35A @ 250V _{AC}	500	0.3	0.15
0.500	189000.0.500	35A @ 250V _{AC}	450	0.3	0.32
0.630	189000.0.630	35A @ 250V _{AC}	400	0.4	0.26
0.800	189000.0.800	35A @ 250V _{AC}	350	0.4	0.57
1	189000.1	35A @ 250V _{AC}	300	0.5	1.1
1.25	189000.1.25	35A @ 250V _{AC}	300	0.6	2
1.6	189000.1.6	35A @ 250V _{AC}	300	0.7	3.3
2	189000.2	35A @ 250V _{AC}	250	0.8	6.2
2.5	189000.2.5	35A @ 250V _{AC}	220	0.9	13
3.15	189000.3.15	35A @ 250V _{AC}	200	1.1	24
4	189000.4	40A @ 250V _{AC}	200	1.3	40
5	189000.5	50A @ 250V _{AC}	180	1.4	80
6.3	189000.6.3	63A @ 250V _{AC}	170	1.6	150
8	189000.8	80A @ 250V _{AC}	160	2.0	240
10	189000.10	100A @ 250V _{AC}	150	2.3	500
12.5	189000.12.5	125A @ 250V _{AC}	140	2.5	650
16	189000.16	160A @ 250V _{AC}	130	2.8	1 250
20	189000.20	200A @ 250V _{AC}	130	4.0	1 600

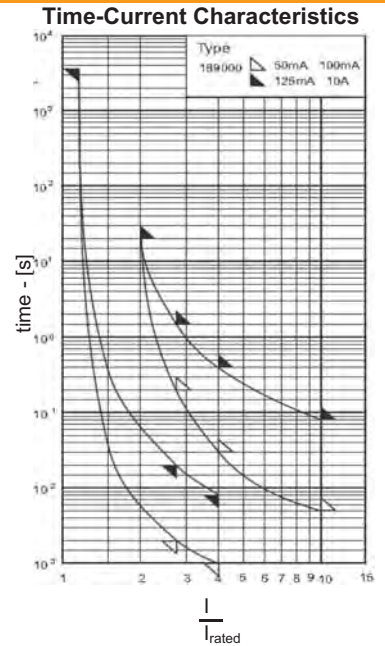

Weight (kg per 100)
Units per Package
10

For 6.3A and higher, consideration should be given to heat dissipation



Dimensions [mm]

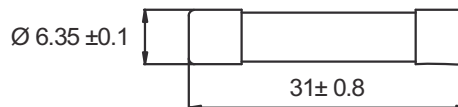

Rated Current	Fusing Time Limits									
	1.5I _n		2I _n		2.75I _n		4I _n		10I _n	
	Min	Max	Min	Max	Min	Max	Min	Max	Min	Max
6.3A - 12.5A	—	—	—	20s	2s	200ms	1ms	30s	—	5ms
16A - 20A	—	—	—	20s	20ms	1.5s	8ms	400ms	—	80ms

G **Rated Voltage** **Rated Breaking Test** **Class** **Standard(s)**



[Un]
500V_{AC}
440V_{DC}

Voltage
500V_{AC}
440V_{AC}

Capacity
50kA
1.5kA



6.3mmx32mm - Ceramic Tube w/Filler, Contacts - Brass, Nickel Plated

Rated Current I_n [A]	Article Number	UL rec	Rated Breaking Current [A]	Voltage Drop [mV]	Dissipation @ 1.5I _n [W]	Pre-arcing I ² t [A ² s]
0.160	189020.0.160	✓	50kA @ 500V _{AC} ¹	7 000	2.5	0.0015
0.200	189020.0.200	✓	50kA @ 500V _{AC} ¹	6 500	2.9	0.0035
0.250	189020.0.250	✓	50kA @ 500V _{AC} ¹	6 000	3.4	0.0085
0.315	189020.0.315	✓	50kA @ 500V _{AC} ¹	1 000	0.9	0.036
0.400	189020.0.400	✓	50kA @ 500V _{AC} ¹	900	1.0	0.07
0.500	189020.0.500	✓	50kA @ 500V _{AC} ¹	850	1.1	0.19
0.630	189020.0.630	✓	50kA @ 500V _{AC} ¹	700	1.3	0.35
0.800	189020.0.800	✓	50kA @ 500V _{AC} ¹	600	1.4	0.49
1	189020.1	✓	50kA @ 500V _{AC} ¹	400	1.2	0.4
1.25	189020.1.25	✓	50kA @ 500V _{AC} ¹	300	1.3	0.8
1.6	189020.1.6	✓	50kA @ 500V _{AC} ¹	300	1.4	1.5
2	189020.2	✓	50kA @ 500V _{AC} ¹	280	1.6	2.5
2.5	189020.2.5	✓	50kA @ 500V _{AC} ¹	260	1.8	5
3.15	189020.3.15	✓	50kA @ 500V _{AC} ¹	240	2.3	9
4	189020.4	✓	50kA @ 500V _{AC} ¹	220	2.6	18
5	189020.5	✓	50kA @ 500V _{AC} ¹	190	2.9	40
6.3	189020.6.3	✓	50kA @ 500V _{AC} ¹	170	3.2	80
8	189020.8		1.5kA @ 500V _{AC} ²	160	3.7	150
10	189020.10		1.5kA @ 500V _{AC} ²	150	4.0	240
12.5	189020.12.5		1.5kA @ 500V _{AC} ²	140	5.5	500
16	189020.16		1.5kA @ 500V _{AC} ²	130	6.5	920
20	189020.20		1.5kA @ 440V _{AC} ²	110	8.4	1 500
25	189020.25		1.5kA @ 440V _{AC} ²	110	11	3 100

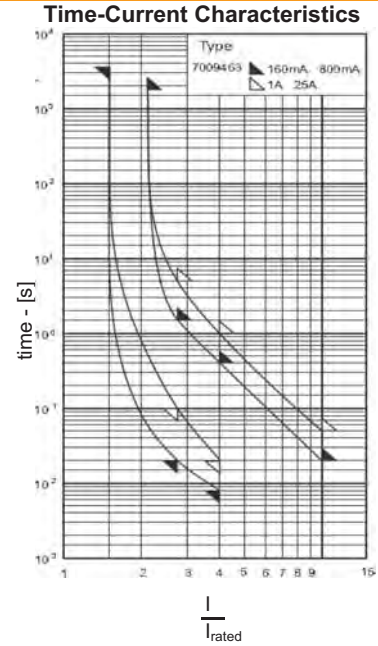

Weight (kg per 100)	1) cosφ = 0.3, 1.5kA @ 450V _{DC} , resistive
Units per Package	2) cosφ = 1, 1.5kA @ 125V _{DC}
10	

For 6.3A and higher, consideration should be given to heat dissipation

AK - with assembled leaded caps
IP - (1 000 pieces)
e.g. 189020.3.15AK



Dimensions [mm]



SMD version available 1A - 5A

Rated Current	Fusing Time Limits									
	1.5I _n		2.1I _n		2.75I _n		4I _n		10I _n	
	Min	Max	Min	Max	Min	Max	Min	Max	Min	Max
160mA - 800mA	1h	—	—	30m	20s	1.5s	8ms	400ms	—	20ms
1A - 25A	1h	—	—	30m	100ms	5s	20ms	1s	—	50ms

G RoHS Rated Voltage [Un] 600V_{AC} Rated Breaking Test Voltage 500V_{AC} Capacity 50kA Class F Standard(s)

6.3mmx32mm - Ceramic Tube w/Filler, Contacts - Brass, Nickel Plated

Rated Current I _n [A]	Article Number	Rated Breaking Current [A]	Voltage Drop [mV]	Power Dissipation @ 1.5I _n [w]	Pre-arcing I ² t [A ² s]
0.200	7009463.0.200	50kA @ 600V _{AC}	6 500	2.9	0.0035
0.400	7009463.0.400	50kA @ 600V _{AC}	900	1.0	0.07
0.500	7009463.0.500	50kA @ 600V _{AC}	800	1.1	0.19
0.800	7009463.0.800	50kA @ 600V _{AC}	600	1.4	0.49
1	7009463.1	50kA @ 600V _{AC}	400	1.2	0.4
2	7009463.2	50kA @ 600V _{AC}	280	1.6	2.5
3	7009463.3	50kA @ 600V _{AC}	260	2.2	7.5
5	7009463.5	50kA @ 600V _{AC}	190	2.9	40
7	7009463.7	50kA @ 600V _{AC}	150	3.8	100
10	7009463.10	50kA @ 600V _{AC}	150	4.0	240

Weight (kg per 100)	For 7A and higher, consideration should be given to heat dissipation
0.12	
Units per Package	
10	

AK - with assembled leaded caps
 IP - (1 000 pieces)
 e.g. 70 094 63.10IP

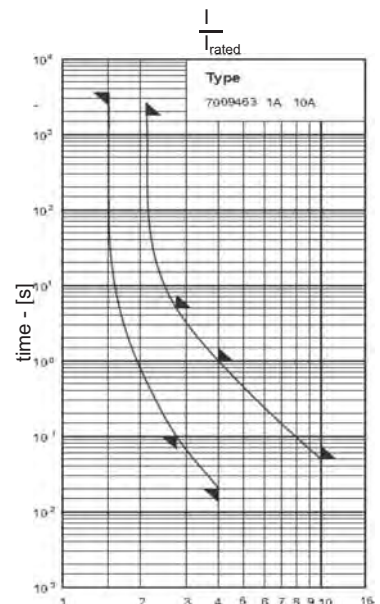
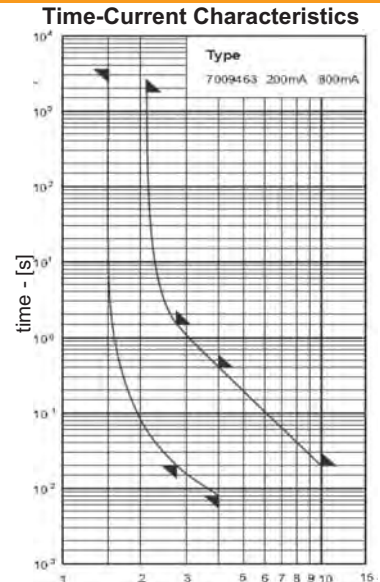

Dimensions [mm]

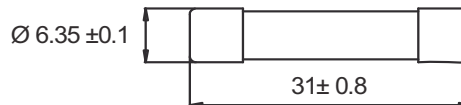

Rated Current	Fusing Time Limits									
	1.5I _n		2.1I _n		2.75I _n		4I _n		10I _n	
	Min	Max	Min	Max	Min	Max	Min	Max	Min	Max
200mA - 800mA	1h	—	—	30m	20s	1.5s	8ms	400ms	—	20ms
1A - 10A	1h	—	—	30m	100ms	5s	20ms	1s	—	50ms

G Rated Voltage Rated Breaking Test Class Standard(s)

RoHS
[Un]
250V_{AC}
Voltage
250V_{AC}
Capacity
35A
T

6.3mmx32mm - Glass Tube, Contacts - Brass, Nickel Plated

Rated Current I_n [A]	Article Number	Rated Breaking Current [A]	Voltage Drop [mV]	Power Dissipation @ 1.5I _n [W]	Pre-arcing I ² t [A ² s]
0.050	189100.0.050	35A @ 250V _{AC}	3 000	0.3	0.035
0.063	189100.0.063	35A @ 250V _{AC}	2 500	0.3	0.04
0.080	189100.0.080	35A @ 250V _{AC}	2 000	0.3	0.08
0.100	189100.0.100	35A @ 250V _{AC}	1 500	0.3	0.17
0.125	189100.0.125	35A @ 250V _{AC}	1 200	0.3	0.26
0.160	189100.0.160	35A @ 250V _{AC}	1 100	0.4	0.44
0.200	189100.0.200	35A @ 250V _{AC}	1 100	0.4	0.6
0.250	189100.0.250	35A @ 250V _{AC}	900	0.5	0.6
0.315	189100.0.315	35A @ 250V _{AC}	300	0.2	0.35
0.400	189100.0.400	35A @ 250V _{AC}	300	0.2	0.49
0.500	189100.0.500	35A @ 250V _{AC}	300	0.3	0.9
0.630	189100.0.630	35A @ 250V _{AC}	300	0.3	1.4
0.800	189100.0.800	35A @ 250V _{AC}	250	0.4	3.2
1	189100.1	35A @ 250V _{AC}	250	0.4	6.5
1.25	189100.1.25	35A @ 250V _{AC}	250	0.4	5
1.6	189100.1.6	35A @ 250V _{AC}	200	0.5	10
2	189100.2	35A @ 250V _{AC}	200	0.6	16
2.5	189100.2.5	35A @ 250V _{AC}	220	0.7	24
3.15	189100.3.15	35A @ 250V _{AC}	200	0.8	42
4	189100.4	40A @ 250V _{AC}	200	1.0	70
5	189100.5	50A @ 250V _{AC}	200	1.3	130
6.3	189100.6.3	63A @ 250V _{AC}	200	1.6	230
8	189100.8	80A @ 250V _{AC}	200	2.0	370
10	189100.10	100A @ 250V _{AC}	150	2.3	630
12.5	189100.12.5	125A @ 250V _{AC}	150	2.8	820
15	189100.15	150A @ 250V _{AC}	150	2.9	925
16	189100.16	160A @ 250V _{AC}	150	3.0	1 200
20	189100.20	200A @ 250V _{AC}	150	4.0	1 600

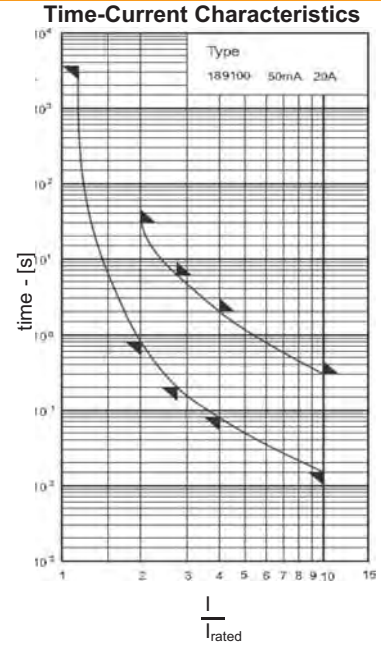

Weight (kg per 100)	For 6.3A and higher, consideration should be given to heat dissipation
Units per Package	
10	

AK - with assembled leaded caps
 IP - (1 000 pieces)
 e.g. 189100.2IP

Dimensions
[mm]



Rated Current	Fusing Time Limits									
	1.5I _n		2I _n		2.75I _n		4I _n		10I _n	
	Min	Max	Min	Max	Min	Max	Min	Max	Min	Max
500mA - 20A	—	—	800ms	30s	200ms	6s	80ms	2s	15ms	300ms

G **Rated Voltage** **Rated Breaking Test** **Class** **Standard(s)**

[Un] **Voltage** **Capacity** **T**

E167295 & E180276 **500V_{AC} - 250V_{AC}** **500V_{AC}** **1.5kA**

400V_{DC} **400V_{DC}** **1.5kA**

6.3mmx32mm - Ceramic Tube w/Filler, Contacts - Brass, Nickel Plated

Rated Current I_n [A]	Article Number	UL rec	Rated Breaking Current [A]	Voltage Drop [mV]	Power Dissipation @ 1.5I _n [W]	Pre-arcing I ² t [A ² s]
0.100	189140.0.100	✓	1.5kA @ 500V _{AC} ¹	3 600	1.3	0.04
0.125	189140.0.125	✓	1.5kA @ 500V _{AC} ¹	3 400	1.4	0.06
0.160	189140.0.160	✓	1.5kA @ 500V _{AC} ¹	3 000	1.5	0.1
0.200	189140.0.200	✓	1.5kA @ 500V _{AC} ¹	2 500	1.6	0.18
0.250	189140.0.250	✓	1.5kA @ 500V _{AC} ¹	2 000	1.7	0.25
0.315	189140.0.315	✓	1.5kA @ 500V _{AC} ¹	1 800	1.8	0.45
0.400	189140.0.400	✓	1.5kA @ 500V _{AC} ¹	1 600	2.0	0.45
0.500	189140.0.500	✓	1.5kA @ 500V _{AC} ¹	450	0.6	0.35
0.630	189140.0.630	✓	1.5kA @ 500V _{AC} ¹	400	0.7	0.49
0.800	189140.0.800	✓	1.5kA @ 500V _{AC} ¹	350	0.8	0.9
1	189140.1	✓	1.5kA @ 500V _{AC} ¹	350	0.9	1.4
1.25	189140.1.25	✓	1.5kA @ 500V _{AC} ¹	300	1.0	3.2
1.6	189140.1.6	✓	1.5kA @ 500V _{AC} ¹	200	1.1	5.2
2	189140.2	✓	1.5kA @ 500V _{AC} ¹	180	1.2	10
2.5	189140.2.5	✓	1.5kA @ 500V _{AC} ¹	160	1.3	19
3.15	189140.3.15	✓	1.5kA @ 500V _{AC} ²	150	1.4	37
4	189140.4	✓	1.5kA @ 500V _{AC} ²	140	1.5	68
5	189140.5	✓	1.5kA @ 500V _{AC} ²	135	2.2	80
6.3	189140.6.3	✓	1.5kA @ 500V _{AC} ²	110	2.2	215
8	189140.8	✓	1.5kA @ 500V _{AC} ²	110	2.6	370
10	189140.10	✓	1.5kA @ 500V _{AC} ²	100	3.0	620
12.5	189140.12.5	✓	1.5kA @ 500V _{AC} ³	100	3.5	1 300
16	189140.16	✓	1.5kA @ 500V _{AC} ³	100	4	2 500
20	189140.20		1.5kA @ 500V _{AC} ³	100	6	3 400
25	189140.25		1.5kA @ 500V _{AC} ³	100	8	5 600
32	189140.32		1.5kA @ 500V _{AC} ³	80	10	3 900

Time-Current Characteristics

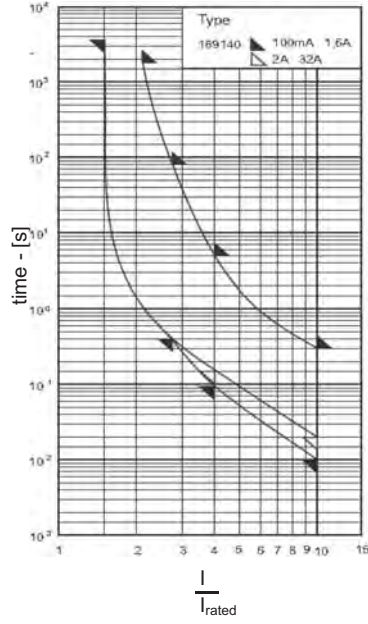

Weight (kg per 100)	¹ cosφ=1, 10kA @ 440V _{AC} cosφ=0.3, 1.5kA @ 400V _{DC} without approval
	² cosφ=1, 10kA @ 440V _{AC} cosφ=0.3, 1.5kA @ 400V _{DC} - UL Recognized
Units per Package	³ cosφ=1, 1.5kA @ 300V _{DC} without approval
10	

AK - with assembled leaded caps
 IP - (1 000 pieces)
 e.g. 189140.1.6IP

Dimensions
[mm]

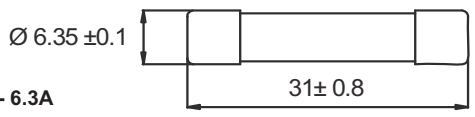

SMD version also available 1A - 6.3A

Rated Current	Fusing Time Limits									
	1.5I _n		2I _n		2.75I _n		4I _n		10I _n	
	Min	Max	Min	Max	Min	Max	Min	Max	Min	Max
100mA - 1.6A	1h	—	30m	—	400ms	80s	95ms	5s	10ms	300ms
2A - 32A	1h	—	30m	—	400ms	80s	150ms	5s	20ms	300ms

G

Rated Voltage
[Un]
250V_{AC}
125V_{AC}

Rated Breaking Test
Voltage Capacity
250V_{AC} 100A
125V_{AC} 10kA

Class
T/D

Standard(s)
UL 248-14
CSA C22.s
No. 248-14

6.3mmx32mm - Glass Tube, Contacts - Brass, Nickel Plated

Rated Current I _n [A]	Article Number	Rated Breaking Current [A]	Voltage Drop Drop [mV]	Power Dissipation @ 1.0I _n [mw]	Pre-arcing I ² t [A ² s]
0.300	189500.0.300	100A @ 250V _{AC} ¹	870	0.26	1.5
0.375	189500.0.375	100A @ 250V _{AC} ¹	840	0.32	2.5
0.400	189500.0.400	100A @ 250V _{AC} ¹	730	0.29	2.5
0.500	189500.0.500	100A @ 250V _{AC} ¹	660	0.33	5.4
0.600	189500.0.600	100A @ 250V _{AC} ¹	600	0.36	3.1
0.700	189500.0.700	100A @ 250V _{AC} ¹	580	0.41	4.5
0.800	189500.0.800	100A @ 250V _{AC} ¹	500	0.40	6.4
1	189500.1	100A @ 250V _{AC} ¹	450	0.45	13
1.25	189500.1.25	100A @ 250V _{AC} ¹	400	0.50	19
1.5	189500.1.5	100A @ 250V _{AC} ¹	370	0.56	25
1.6	189500.1.6	100A @ 250V _{AC} ¹	350	0.56	32
2	189500.2	100A @ 250V _{AC} ¹	330	0.66	55
2.5	189500.2.5	100A @ 250V _{AC} ¹	290	0.73	90
2.8	189500.2.8	100A @ 250V _{AC} ¹	270	0.76	120
3	189500.3	100A @ 250V _{AC} ¹	250	0.75	160
3.2	189500.3.2	100A @ 250V _{AC} ¹	220	0.70	350
4	189500.4	10kA @ 125V _{AC} ²	200	0.80	590
5	189500.5	10kA @ 125V _{AC} ²	200	1.0	600
6.25	189500.6.25	10kA @ 125V _{AC} ²	200	1.3	1 300

Weight (kg per 100)	¹⁾ 10kA@125V _{AC} , 100A@250V _{AC} - cosφ = 0.7 - 0.8
	²⁾ 10kA@125V _{AC} , cosφ = 0.7 - 0.8
Units per Package	10

AK - with assembled leaded caps
 IP - (1 000 pieces)
 e.g. 189500.1.25IP

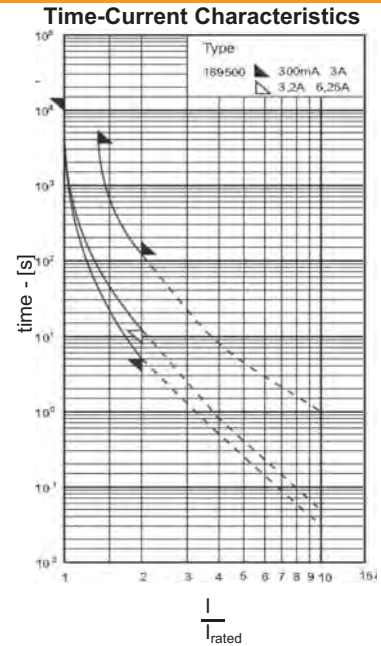

Dimensions [mm]

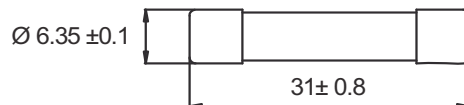

Rated Current	Fusing Time Limits									
	1I _n		1.35I _n		2I _n					
	Min	Max	Min	Max	Min	Max	Min	Max	Min	Max
300mA - 3A	4h	—	—	1h	5s	—	—	—	—	—
3.2A - 6.25A	4h	—	—	1h	12s	—	—	—	—	—

G

RoHS

Rated Voltage [Un] 400V _{AC}	Rated Breaking Test Voltage 400V _{AC} Capacity 30kA	Class gPV	Standard(s) Following IEC 60269-4
--	---	---------------------	--

6.3mmx32mm - Ceramic Tube w/Filler, Contacts - Brass, Nickel Plated

Rated Current I_n [A]	Article Number	Rated Breaking Current [A]	Voltage Drop [mV]	Power Dissipation @ 1.0I _n [W]	Pre-arcing I ² t [A ² s]	Total I ² t [A ² s]
1	7006526.1	30kA @ 400V _{DC}	600	0.60	0.58	1.1
1.25	7006526.1.25	30kA @ 400V _{DC}	500	0.63	1.1	2.2
1.6	7006526.1.6	30kA @ 400V _{DC}	375	0.6	3.2	6.5
2	7006526.2	30kA @ 400V _{DC}	300	0.6	7.1	15
2.5	7006526.2.5	30kA @ 400V _{DC}	270	0.7	14	30
3.15	7006526.3	30kA @ 400V _{DC}	250	0.8	11	22
4	7006526.4	30kA @ 400V _{DC}	220	0.9	23	50
5	7006526.5	30kA @ 400V _{DC}	210	1.1	42	85
6.3	7006526.6.3	30kA @ 400V _{DC}	200	1.3	83	150
8	7006526.8	30kA @ 400V _{DC}	175	1.4	150	300

Weight (kg per 100)
Units per Package
10

AK - with assembled leaded caps
IP - (1 000 pieces)
e.g. 70 065 26.10IP

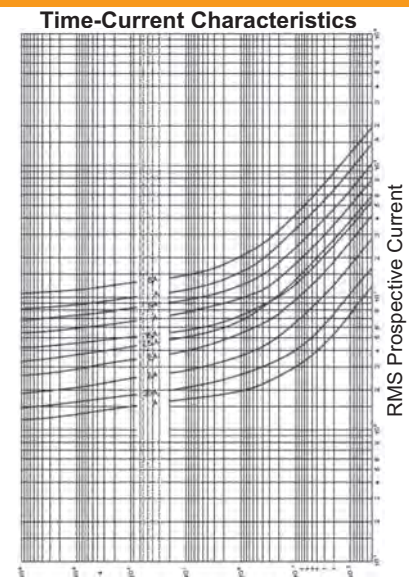

Dimensions
[mm]

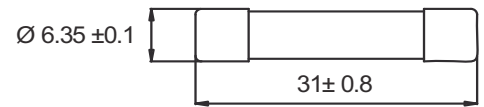

Rated Current	Fusing Time Limits									
	1.1I _n		1.45I _n							
	Min	Max	Min	Max	Min	Max	Min	Max	Min	Max
300mA - 8A	1h	—	—	1h	—	—	—	—	—	—

G

RoHS
Rated Voltage
[Un]
500V_{AC}
Rated Breaking Test
Voltage
500V_{AC}
Capacity
50A
Class
M/F
Standard(s)
DIN 41686

8mmx40mm - Glass Tube(M), Ceramic Tube(F), Contacts - Brass, Nickel Plated

Rated Current I_n [A]	Article Number	Rated Breaking Current [A]	Voltage Drop [mV]	Power Dissipation @ 1.0I _n [W]	Pre-arcing I ² t [A ² s]		
M							
0.032	183000.0.032	80A @ 500V _{AC}	2 300	Data On Request			
0.050	183000.0.050	80A @ 500V _{AC}	1 600				
0.063	183000.0.063	80A @ 500V _{AC}	1 300				
0.080	183000.0.080	80A @ 500V _{AC}	950				
0.100	183000.0.100	80A @ 500V _{AC}	700				
F							
0.125	183000.0.125	1.5kA @ 500V _{AC}	6 300				
0.160	183000.0.160	1.5kA @ 500V _{AC}	4 700				
0.200	183000.0.200	1.5kA @ 500V _{AC}	3 600				
0.250	183000.0.250	1.5kA @ 500V _{AC}	2 800				
0.315	183000.0.315	1.5kA @ 500V _{AC}	2 100				
0.400	183000.0.400	1.5kA @ 500V _{AC}	1 600				
0.500	183000.0.500	1.5kA @ 500V _{AC}	1 250				
0.630	183000.0.630	1.5kA @ 500V _{AC}	1 000				
0.800	183000.0.800	1.5kA @ 500V _{AC}	800				
1	183000.1	1.5kA @ 500V _{AC}	620				
1.25	183000.1.25	1.5kA @ 500V _{AC}	520				
1.6	183000.1.6	1.5kA @ 500V _{AC}	450				
2	183000.2	1.5kA @ 500V _{AC}	400				
2.5	183000.2.5	1.5kA @ 500V _{AC}	370				
3.15	183000.3.15	1.5kA @ 500V _{AC}	340				
4	183000.4	1.5kA @ 500V _{AC}	320				
5	183000.5	1.5kA @ 500V _{AC}	310				
6.3	183000.6.3	1.5kA @ 500V _{AC}	300				

Weight (kg per 100)
Units per Package



Dimensions [mm]

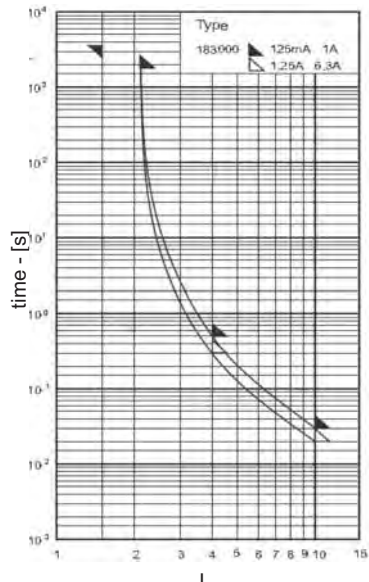
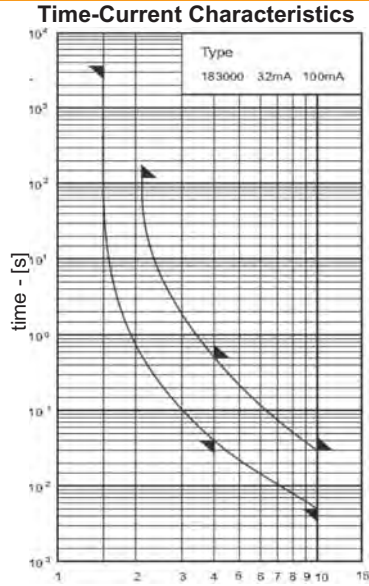

Rated Current	Fusing Time Limits									
	1.5I _n		2.1I _n		2.75I _n		4I _n		10I _n	
	Min	Max	Min	Max	Min	Max	Min	Max	Min	Max
32mA - 100mA	1h	—	—	2m	—	—	40ms	500ms	5ms	30ms
125mA - 1A	1h	—	—	30m	—	—	—	400ms	—	30ms
1.25A - 6.3A	1h	—	—	30m	—	—	—	300ms	—	20ms

G

RoHS

	Rated Voltage [Un] 1.2kV _{AC} 3kV _{AC}	Rated Breaking Test Voltage 1.2kV _{AC} 3kV _{AC}	Capacity 35A 35A
--	--	---	-------------------------------

Class
M/F

Standard(s)
DIN 41570
DIN 41569

8mmx50mm - F400mA

8mmx85mm - Ceramic Tube, Contacts - Brass, Nickel Plated F2A

Rated Current I_n [A]	Article Number		Rated Breaking Current [A]	Voltage Drop Maximum [mV]	Voltage Drop Maximum [mV]	
	M	F				
	M			184000	185000	
0.032	184000.0.032	185000.0.032	184000 35A @ 1.2kV_{AC}	2 300	4 500	
0.050	184000.0.050	185000.0.050		1 900	3 000	
0.063	184000.0.063	185000.0.063		1 700	2 400	
0.080	184000.0.080	185000.0.080		1 500	1 900	
0.100	184000.0.100	185000.0.100		1 300	1 500	
	F					
0.125	184000.0.125	185000.0.125		185000 35A @ 3kV_{AC}	9 500	17 500
0.160	184000.0.160	185000.0.160			8 000	14 000
0.200	184000.0.200	185000.0.200			7 000	12 000
0.250	184000.0.250	185000.0.250			6 000	10 500
0.315	184000.0.315	185000.0.315	5 000		9 000	
0.400	184000.0.400	185000.0.400	2 000		3 500	
0.500	184000.0.500	185000.0.500	950		1 600	
0.630	184000.0.630	185000.0.630	860		1 500	
0.800	184000.0.800	185000.0.800	760		1 300	
1	184000.1	185000.1	640		1 200	
1.25	184000.1.25	185000.1.25	540	1 000		
1.6	184000.1.6	185000.1.6	500	900		
2	184000.2	185000.2	460	800		
2.5	184000.2.5	185000.2.5	On Request			
3.15	184000.3.15	185000.3.15	On Request			
4	184000.4	185000.4	On Request			
5	184000.5		On Request			
6.3	184000.6.3		On Request			

Time-Current Characteristics

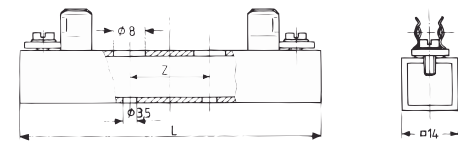
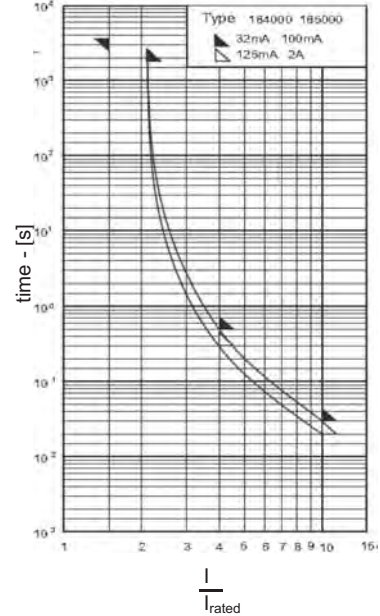

Weight (kg per 100)	Weight (kg per 100)
Units per Package	Units per Package

Fuse Base Article No.	Fuse	Rated Voltage	Dimensions [mm]		Rated Current A	Rated Power W
			L	Z		
71 034 01	184000	1.2kV	75	20	6.3	4
71 037 01	185000	3kV	110	20	4	4

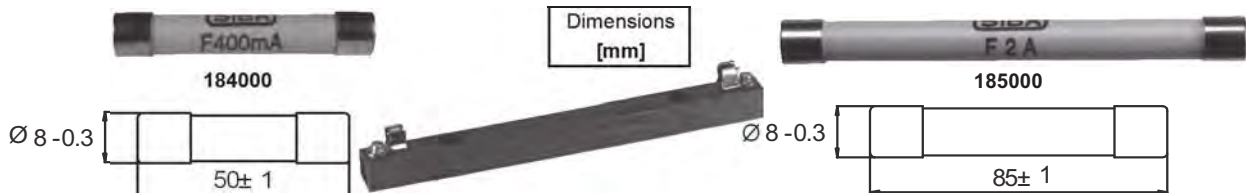

	Rated Current	Fusing Time Limits									
		1.5I _n		2.1I _n		2.75I _n		4I _n		10I _n	
		Min	Max	Min	Max	Min	Max	Min	Max	Min	Max
	32mA - 100mA	1h	—	—	30m	—	—	—	500ms	—	30ms
<u>184000</u>	125mA - 6.3A	1h	—	—	30m	—	—	—	300ms	—	20ms
<u>185000</u>	125mA - 4A	1h	—	—	30m	—	—	—	300ms	—	20ms

G

RoHS

Rated Voltage	Rated Breaking Test	Class	Standard(s)
[Un] 6kV _{AC} 10kV _{AC}	Voltage Capacity 6kV _{AC} 35A 10kV _{AC} 35A	M/F	DIN 41683 DIN 41684

8mmx120mm -
8mmx150mm - Ceramic Tube, Contacts - Brass, Nickel Plated

Rated Current I _n [A]	Article Number	Article Number	Rated Breaking Current [A]	Voltage Drop Maximum [mV]	Voltage Drop Maximum [mV]	
	M			186000	187000	
0.032	186000.0.032	187000.0.032	186000 35A @ 6kV_{AC}	6 000	14 000	
0.050	186000.0.050	187000.0.050		4 400	8 500	
0.063	186000.0.063	187000.0.063		3 800	6 500	
0.080	186000.0.080	187000.0.080		3 200	5 000	
0.100	186000.0.100	187000.0.100		2 900	4 000	
	F					
0.125	186000.0.125	187000.0.125		187000 35A @ 10kV_{AC}	22 000	27 000
0.160	186000.0.160	187000.0.160			19 000	24 000
0.200	186000.0.200	187000.0.200			16 000	21 000
0.250	186000.0.250	187000.0.250			14 000	18 500
0.315	186000.0.315	187000.0.315	12 000		17 000	
0.400	186000.0.400	187000.0.400	5 000		6 000	
0.500	186000.0.500	187000.0.500	2 300		2 900	
0.630	186000.0.630	187000.0.630	2 000		2 700	
0.800	186000.0.800	187000.0.800	1 900		2 400	
1	186000.1	187000.1	1 800		2 100	
1.25	186000.1.25	187000.1.25	1 400	1 800		
1.6	186000.1.6	187000.1.6	1 300	1 600		
2	186000.2	187000.2	1 100	1 400		
2.5	186000.2.5		On Request			
3.15	186000.3.15		On Request			
4	186000.4		On Request			

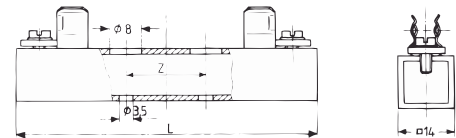
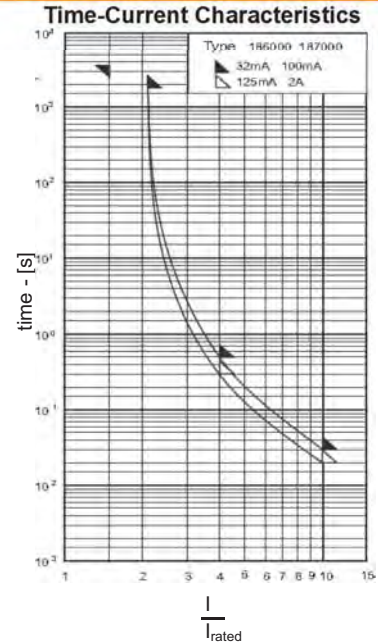

Weight (kg per 100)	Weight (kg per 100)
Units per Package	Units per Package

Fuse Base Article No.	Fuse	Rated Voltage	Dimensions [mm]		Rated Current	Rated Power
			L	Z	A	W
71 040 01	186000	6kV	145	80	4	4
71 043 01	187000	10kV	175	100	2	4



186000

Dimensions [mm]

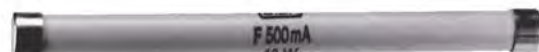

187000

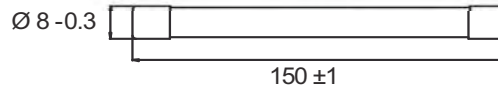
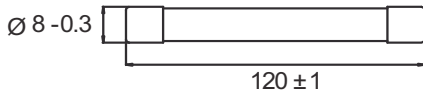

	Rated Current	Fusing Time Limits									
		1.5I _n		2.1I _n		2.75I _n		4I _n		10I _n	
		Min	Max	Min	Max	Min	Max	Min	Max	Min	Max
	32mA - 100mA	1h	—	—	30m	—	—	—	500ms	—	30ms
186000	125mA - 6.3A	1h	—	—	30m	—	—	—	300ms	—	20ms
187000	125mA - 4A	1h	—	—	30m	—	—	—	300ms	—	20ms

G



Miniature G High Voltage Fuses

Standard(s)
Company

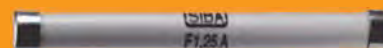

Ceramic Tube w/Filler, Contacts - Copper Alloy, Silver Plated

Article Number	Voltage Rating	Dimensions	Current Ratings	Class	Breaking Capacity
7011509	3kV _{AC}	10mmx85mm	0.125A - 4A	F	150A
7011527	1.5kV _{AC} /1kV _{DC}	10mmx85mm	0.63A - 12.5A	T	/10kA _{DC}
7011552	1.5kV _{AC} /1kV _{DC}	10mmx85mm	1A - 20A	F	1.5kA _{AC} /300A _{DC}
7012927	1kV _{AC}	11mmx79mm	2A - 16A	T	15kA
7012952	1kV _{AC}	11mmx79mm	1A - 12A	F	15kA
7017182	1kV _{AC}	10mmx85mm	2A - 16A	aM	25kA
7002924	3kV _{AC}	12mmx100mm	0.5A - 10A	F	300A
7002927	3kV _{AC}	12mmx100mm	2.5A - 6.3A	T	300A
7003024	6kV _{AC}	12mmx150mm	0.5A - 4A	F	300A
7003124	10kV _{AC}	12mmx200mm	0.5A - 2A	F	300A



71 037 02

Fuse Holder				
Article Number	Voltage Rating	Current Ratings	Fuse Size	Rated Power
7103702	3kV	6.3A	10mmx85mm	4W



71 029 01

71 030 01

71 031 01

Fuse Base				
Article Number	Voltage Rating	Current Ratings	Fuse Size	Rated Power
7102901	3kV	6.3A	12mmx100mm	4W
7103001	6kV	4A	12mmx150mm	4W
7103101	10kV	2A	12mmx200mm	4W

G



RoHS



Fuse Holders (Fuse Blocks) for miniature Fuse Links 5mm x 20mm

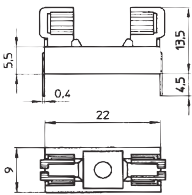

199015

approvals UL(rec), VDE

rated voltage 250 V_{AC}
 rated current 6,3 A
 rated power 1,6 W
 mounting printed circuit board, screw or rivet
 pin distance 22.5 mm
 hole Ø 1.5 mm
 connections solder
 cover 199016 thermoplastic. transparent

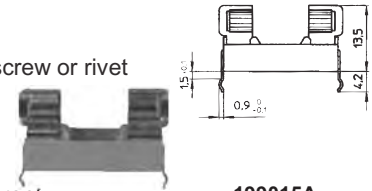

199015A

approvals UL(rec), VDE

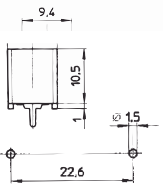
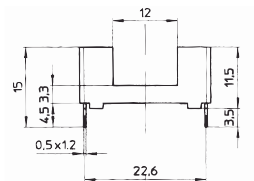

199018

approvals UL(rec), VDE

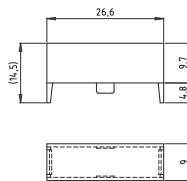

199016

rated voltage 250 V_{AC}
 rated current 6,3 A
 rated power 1,6 W
 mounting printed circuit board
 pin distance 22.5 mm
 hole Ø 1.5 mm
 connections solder
 cover 199016 thermoplastic. Green

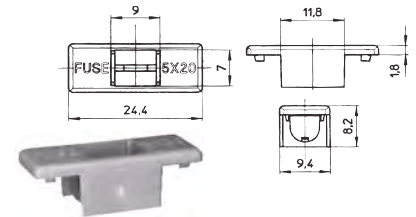

199019

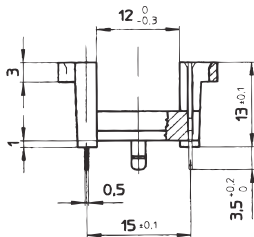

199060

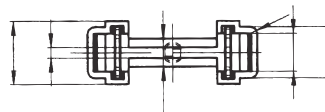

rated voltage 250 V_{AC}
 rated current 6,3 A
 rated power 1,6 W
 mounting printed circuit board
 pin distance 15 mm
 hole Ø 1.3 mm / 2.6mm
 connections solder

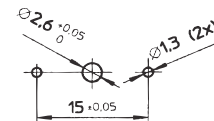

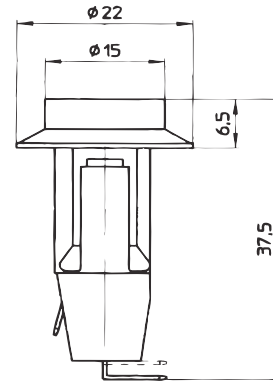
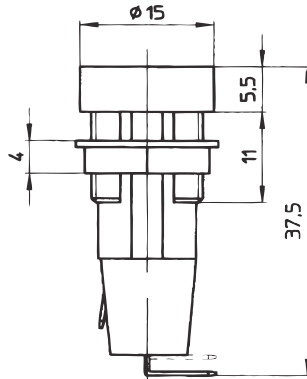
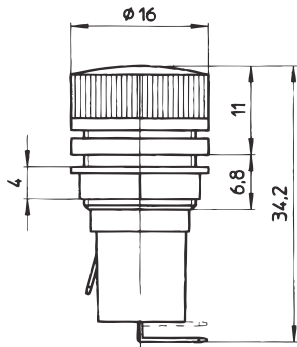
**199030**

approvals UL(rec), VDE
 mounting panel
 hole 13mm
 locating lug
 locknut SW14
 fuse carrier screw cap
 connections 2.8mm plug connector
 or solderable

199035

approvals UL(rec), VDE
 mounting panel
 hole 12.7mm
 locating lug
 locknut SW14
 fuse carrier screw cap
 connections 2.8mm plug connector
 or solderable

199040

approvals UL(rec), VDE
 mounting panel
 hole 12.7mm
 locating lug
 locknut SW14
 fuse carrier screw cap
 connections 2.8mm plug connector
 or solderable

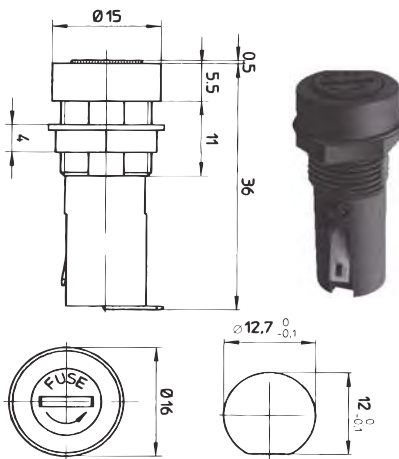

rated voltage	250 V
rated current	6.3 A
rated power	2.5 W
dielectric strength	3 kV
protection standard	IP 40
shock safe category	PC2

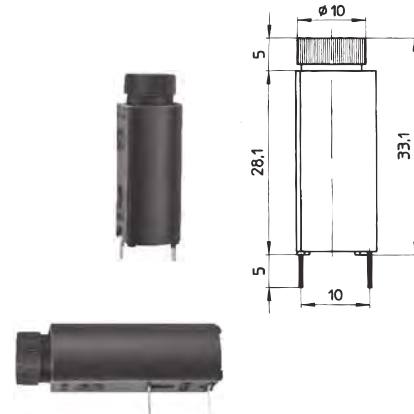
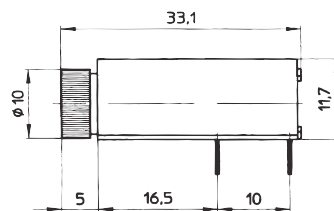
**199055**

mounting panel
 hole 12.7mm
 locating lug
 locknut SW14
 fuse carrier bayonet cap
 connections solder
 approvals UL(rec), VDE

199050

mounting PCB
 pin distance 10mm
 via hole $\varnothing 1.3 \pm 0.1$ mm
 fuse carrier bayonet cap
 connections solder
 approvals UL(rec), VDE

199045

mounting PCB
 pin distance 10mm
 via hole $\varnothing 1.3 \pm 0.1$ mm
 fuse carrier bayonet cap
 connections solder
 approvals UL(rec), VDE

G



RoHS



Fuse Holders (Fuse Blocks) for miniature Fuse Links 5mm x 20mm

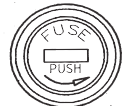
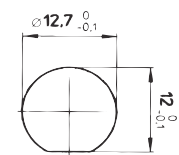
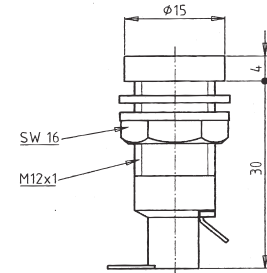
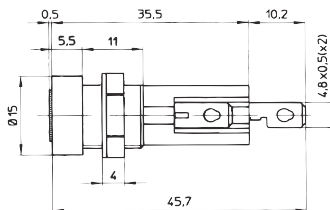

199070

199090

rated voltage 250 V
 rated current 6.3 VDE / 10A UL/CSA
 rated power 2.5 W
 dielectric strength 3 kV
 protection standard IP 40
 shock safe category PC2
 mounting panel
 hole 12.7mm
 locating lug
 locknut SW14
 fuse carrier bayonet cap
 connections 4.8mm plug connector
 approvals UL(rec), VDE

rated voltage 250 V
 rated current 6.3 VDE / 10A UL/CSA
 rated power
 dielectric strength 3 kV
 protection standard IP 40
 shock safe category PC2
 mounting panel
 hole 12.7mm
 locating lug
 locknut SW16
 fuse carrier bayonet cap
 connections solder
 approvals UL(rec) CSA (10A), VDE SEMK0(6.3A)



In Line Fuse Holders for miniature Fuse Links 5mm x 20mm

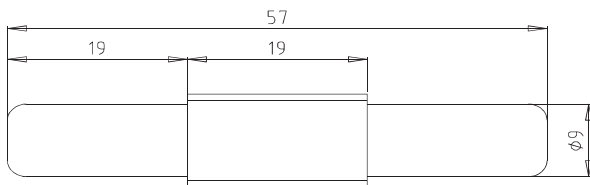

199080

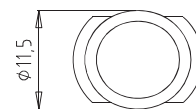

rated voltage 250 V
 rated current 6
 rated power 1.6 W
 mounting in line fuse holder
 locking bayonet type
 connections solderable



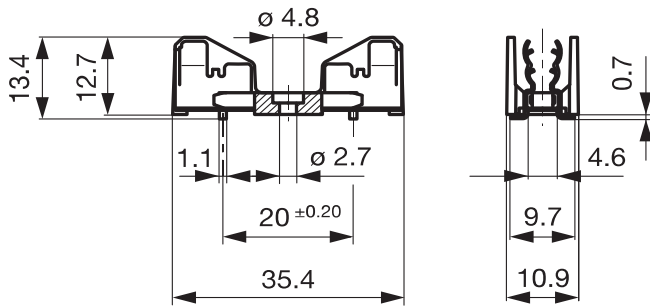

Solder Pad

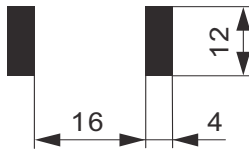

199511

rated voltage	500V (VDE) / 600V _{AC/DC} (UL/CSA)
rated current	10A (VDE) / 16A (UL/CSA)
rated power	4 W
dielectric strength	3 kV
mounting	surface mount
fixing	rivet or screw
connections	solder
approvals	UL(rec), VDE

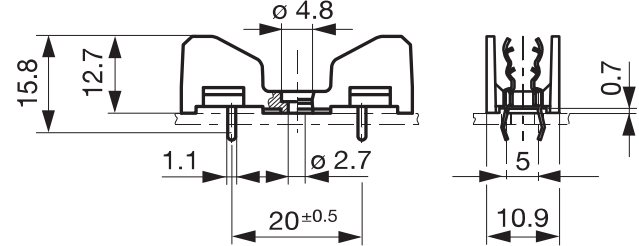

Drill Pattern

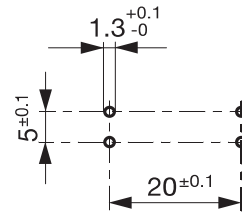

199537

rated voltage	500V (VDE) / 600V _{AC/DC} (UL/CSA)
rated current	10A (VDE) / 16A (UL/CSA)
rated power	4 W
dielectric strength	3 kV
mounting	PCB
fixing	rivet or screw
connections	solder
approvals	UL(rec), VDE

G



Fuse Holders (Fuse Blocks) for miniature Fuse Links 6.3mm x 32mm

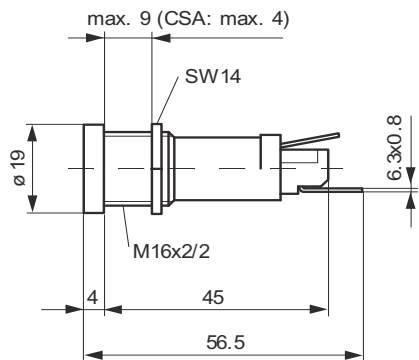

Hole Pattern

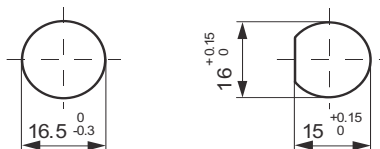

199531

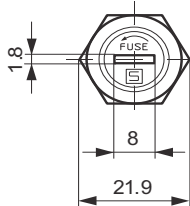

199530

rated voltage	500V (VDE) / 600V _{AC/DC} (UL/CSA)
rated current	10A (VDE) / 20A (UL/CSA)
rated power	4 W @ 10A
dielectric strength	3 kV
protection standard	IP 40
shock safe category	PC2
mounting	panel
hole	16.5mm
locating lug	
locknut	
fuse carrier	bayonet cap
connections	6.3x0.8mm plug connector

Approvals UL(rec), VDE

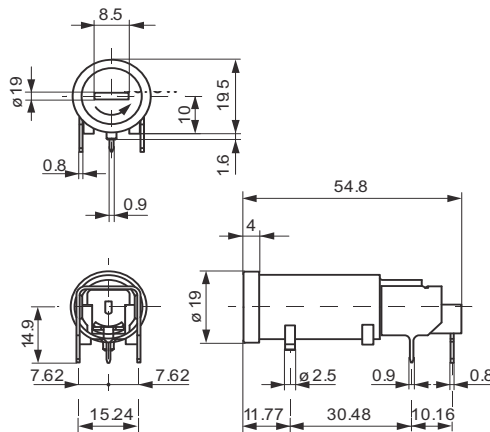

rated voltage	500V (VDE) / 600V _{AC/DC} (UL/CSA)
rated current	16A (VDE) / 30A (UL/CSA)
rated power	4 W @ 16A
dielectric strength	3 kV
protection standard	IP 40
shock safe category	PC2
mounting	PCB
fuse carrier	screw cap
connections	solderable THT



199550

approvals UL(rec), VDE

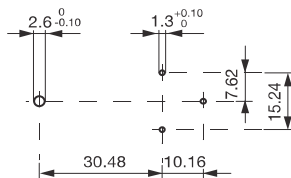

199552



RoHS



Fuse Holders (Fuse Blocks) for miniature Fuse Links 6.3mm x 32mm

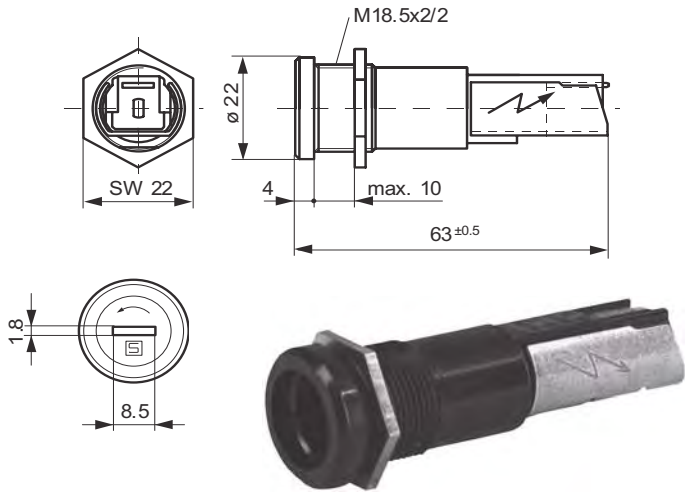

199555

approvals	UL(rec), VDE
rated voltage	500V (VDE) / 600V _{AC/DC} (UL/CSA)
rated current	16A (VDE) / 30A (UL/CSA)
rated power	4 W @ 16A
dielectric strength	3 kV
protection standard	IP 40
shock safe category	PC2
mounting	panel
fixing	nut
fuse carrier	screw cap
connections	6.3x0.8mm plug connector



199552

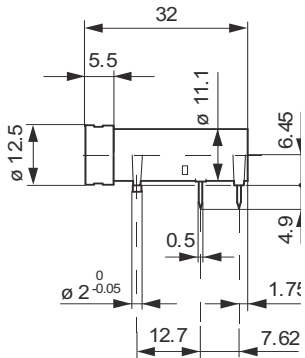

7100127

approvals UL(rec), VDE

rated voltage	250V _{AC}
rated current	10A (VDE) / 16A (UL/CSA)
rated power	2.5 W @ 10A
dielectric strength	3 kV
protection standard	IP 40
shock safe category	PC2
mounting	PCB
pin distance	7.62x5.08mm
via hole	Ø 1.3 ± 0.1 mm
fuse carrier	bayonet cap
connections	solder

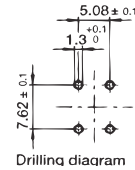
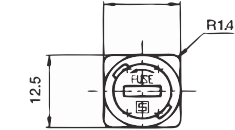
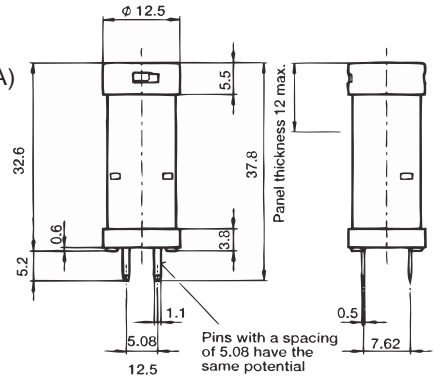

7100128

approvals UL(rec), VDE

G



RoHS



Fuse Holders (Fuse Blocks) for miniature Fuse Links 5mm x 20mm

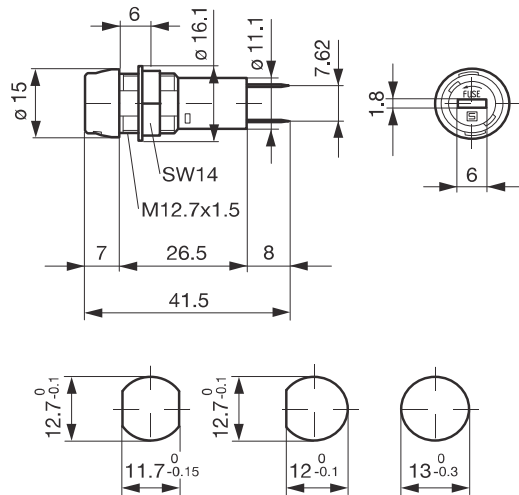

rated voltage	250 V _{AC}
rated current	10 VDE / 16A UL/CSA
rated power	2.5 W @ 10A
dielectric strength	3 kV
protection standard	IP 40
shock safe category	PC2
mounting	panel
hole	13mm
distortion protection	
locknut	M12.7x1.5
fuse carrier	bayonet cap
connections	solder

7100129

approvals UL(rec), VDE

RoHS

Fuse Holders (Fuse Blocks) for miniature Fuse Links 6.3mm x 32mm

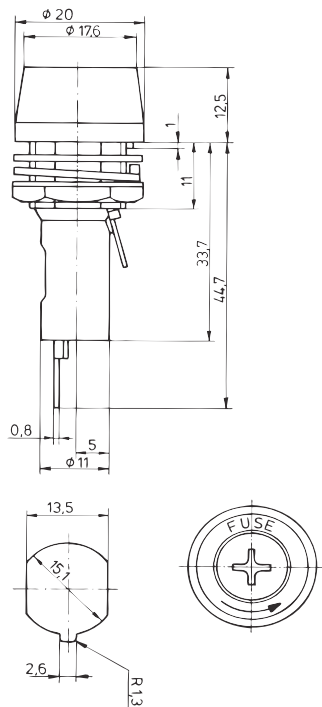

rated voltage	250 V
rated current	20A
rated power	
dielectric strength	3 kV
protection standard	IP 40
shock safe category	
mounting	panel
hole	15.1mm
locating lug	
locknut	SW18
fuse carrier	bayonet cap
connections	solder

199052



Press on leads for miniature Fuse Links 5mm x 20mm and 6.3mm x 32mm

Ø 5mm

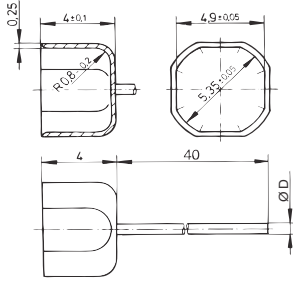

Ø 6.3mm

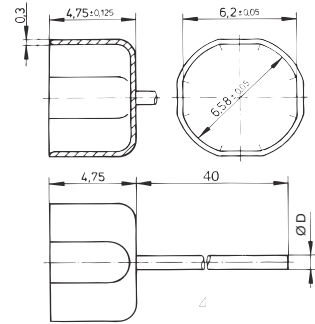

Ø 5mm

- 204000 Max 6.3A D=0.65mm
- 204001 Max 10A D=0.8mm
- 204002 Max 16A D=1mm

Ø 6.3mm

- 204100 Max 12.5A D=0.8mm
- 204101 Max 20A D=1mm

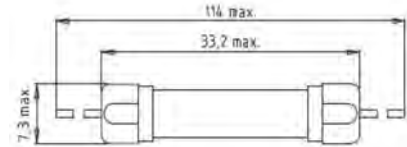
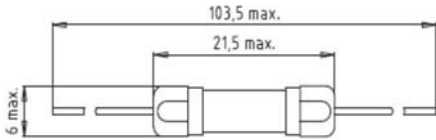

Fuse Holders (Fuse Blocks) for miniature Fuse Links 6.3x32mm

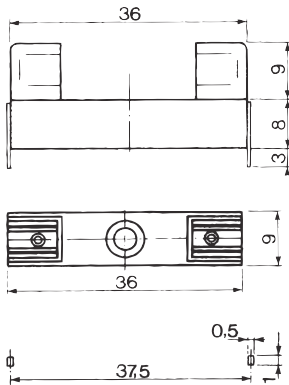

199022

- | | |
|---------------------|-------------|
| rated voltage | 250 V |
| rated current | 10A |
| mounting | panel |
| dielectric strength | 3 kV |
| protection standard | IP 40 |
| shock safe category | |
| mounting | panel |
| hole | 0.5x1mm |
| locating lug | |
| locknut | SW18 |
| fuse carrier | bayonet cap |
| connections | solder |



G **UL** **RoHS** **VDE** Fuse Holders (Fuse Blocks) for miniature Fuse Links 5mm x 20mm or 6.3mm x 32mm

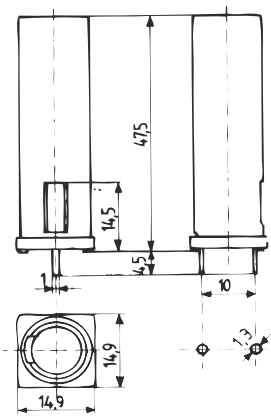
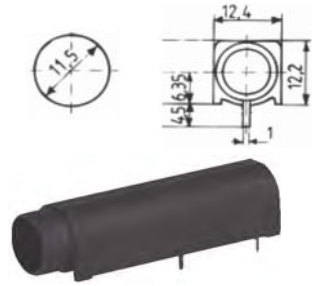
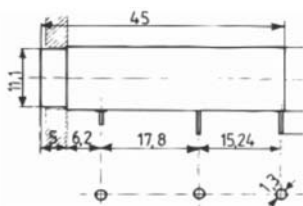

7100114
 approvals UL(rec), VDE, CSA
 rated voltage 250V_{AC}
 rated current 10A (VDE) / 16A (UL/CSA)
 rated power 2.5 W @ 10A(5x20mm)
 rated power 3.2 W @ 10A(6.3x32mm)
 dielectric strength 3 kV
 protection standard IP 40
 shock safe category PC2
 mounting PCB
 pin distance 15.24mm
 via hole Ø 1.3 +0.1 mm
 fuse carrier bayonet cap
 connections solder

7100116
 approvals UL(rec), VDE, CSA
 rated voltage 250V_{AC}
 rated current 10A (VDE) / 16A (UL/CSA)
 rated power 2.5 W @ 10A(5x20mm)
 rated power 3.2 W @ 10A(6.3x32mm)
 dielectric strength 3 kV
 protection standard IP 40
 shock safe category PC2
 mounting PCB
 pin distance 10mm
 via hole Ø 1.3 +0.1 mm
 fuse carrier bayonet cap
 connections solder



5x20mm



6.3x32

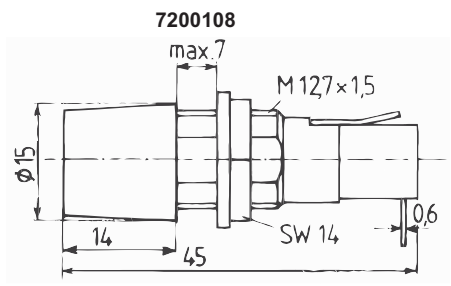

7200108

rated voltage 250V
 rated current 10A (VDE) / 20A (UL)
 rated power 4 W @ 10A
 dielectric strength 3 kV
 protection standard IP 40
 shock safe category PC2
 mounting panel
 hole 13mm
 locating lug
 locknut
 fuse carrier bayonet cap
 connections solder

rated voltage 250V
 rated current 10A (VDE) / 20A (UL)
 rated power 4 W @ 10A
 dielectric strength 3 kV
 protection standard IP 40
 shock safe category PC2
 mounting panel
 hole 13mm
 locating lug
 locknut
 fuse carrier bayonet cap
 connections solder

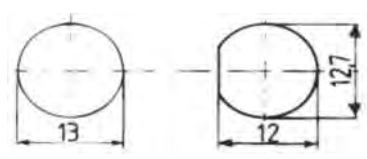

7100123

approvals UL(rec) 20A, VDE 10A

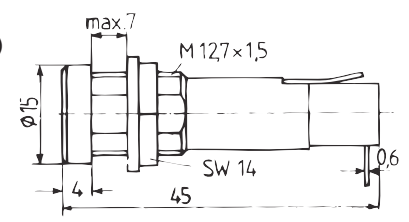

7100124

approvals UL(rec), VDE, CSA

SIBA Cross Reference

ELU → SIBA						SIBA → ELU					
ELU	SIBA	page	ELU	SIBA	page	SIBA	ELU	page	SIBA	ELU	page
157000	7016974	586	184000	70 032 09	631	7000102	172000	604	7004310	187000	632
158000	7016975	587	184000	70 034 09	631	7000134	179020	601	7005437	196000	597
160000	7017373	588	185000	70 035 09	631	7000135	179120	606	7005960	189000	623
164000	7016072	592	185000	70 037 09	631	7000140	70 001 40	598	7005961	189100	626
164050	7015972	592	186000	70 038 10	632	7000176	179500	611	7005976	189500	628
164500	7016371	593	186000	70 040 10	632	7000179	179150	607	7006563	189020	624
164550	7016271	593	187000	70 041 10	632	7000181	190000	612	7006565	189140	627
165000	7016002	594	187000	70 043 10	632	7000202	172525	613	7008913	7008913	617
165050	7015902	594	189000	70 059 60	623	7000234	171525	563	7012540	7012540	620
166000	7016073	595	189020	70 065 63	624	7000302	172530	619	7014311	183000	630
166050	7015973	595	189100	70 059 61	626	7000334	171530	619	7015902	165050	594
166500	7016376	596	189140	70 065 65	629	7000401	171100	603	7015972	164050	592
166550	7016276	596	189500	70 059 76	628	7000402	172100	604	7015973	166050	595
166602	7115801	634	190000	70 001 81	612	7000403	173100	610	7016002	165000	594
171100	7000401	603	196000	70 054 37	597	7000502	172525	613	7016072	164000	592
171525	7000234	603	199073	74 001 02	634	7000602	172530	619	7016073	166000	595
171526	7001004	615	199207	74 001 03	634	7000702	172200	605	7016102	165000GT	594
171530	7000334	619	204000	73 001 01	642	7000733	179021	602	7016172	164000GT	592
172000	7000102	604	204100	73 001 02	642	7000740	7000740	599	7016173	166000GT	595
172100	7000402	604	7000140	70 001 40	598	7000765	179200	604	7016271	164550	593
172200	7000702	605	7000740	70 007 40	599	7001004	171526	615	7016276	166550	596
172525	7000202	613	7001205	70 012 05	618	7001005	172526	615	7016371	164500	593
172525	7000502	613	7001407	70 014 07	618	7001105	172526	615	7016376	166500	596
172526	7001005	615	7001607	70 016 07	618	7001205	7001205	618	7016471	164500GT	593
172526	7001105	615	7001707	70 017 07	618	7001407	7001407	618	7016476	166500GT	596
172530	7000302	617	7001908	70 019 08	614	7001607	7001607	618	7016974	157000	586
172530	7000602	619	7008913	70 089 13	617	7001707	7001707	618	7016975	158000	587
173100	7000403	610	7012540	70 125 40	620	7001908	7001908	614	7017074	157000GT	586
179020	7000134	601	157000GT	70 170 74	586	7003209	184000	631	7017075	158000GT	587
179021	7000733	602	158000GT	70 170 75	587	7003409	184000	631	7017373	160000	588
179120	7000135	606	160000GT	70 174 73	588	7003509	185000	631	7017473	160000GT	588
179150	7000179	607	164000GT	70 161 72	592	7003709	185000	631	7115801	166602	626
179200	7000765	604	164500GT	70 164 71	593	70038 0	186000	632	7300101	204000	643
179500	7000176	611	165000GT	70 161 02	594	7004010	186000	632	7300102	204100	643
183000	7014311	630	166000GT	70 161 73	595	7004110	187000	632	7400102	199073	634
			166500GT	70 164 76	596				7400103	199207	634