

**TRIPLE HIGH-SIDE MOSFET DRIVER**

- OVERVOLTAGE CHARGE PUMP SHUT OFF FOR  $V_{VS} > 25V$
- REVERSE BATTERY PROTECTION (REFERING TO THE APPLICATION CIRCUIT DIAGRAM)
- PROGRAMMABLE OVERLOAD PROTECTION FUNCTION FOR CHANNEL 1 AND 2
- OPEN GROUND PROTECTION FUNCTION FOR CHANNEL 1 AND 2
- CONSTANT GATE CHARGE/DISCHARGE CURRENT

**DESCRIPTION**

The L9380 device is a controller for three external N-channel power MOS transistors in "High-Side Switch" configuration. It is intended for relays replacement in automotive electric control units.

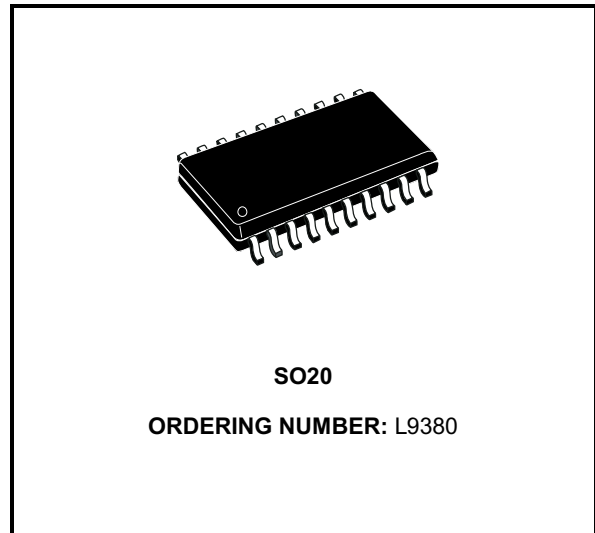

**PIN CONNECTION** (Top view)

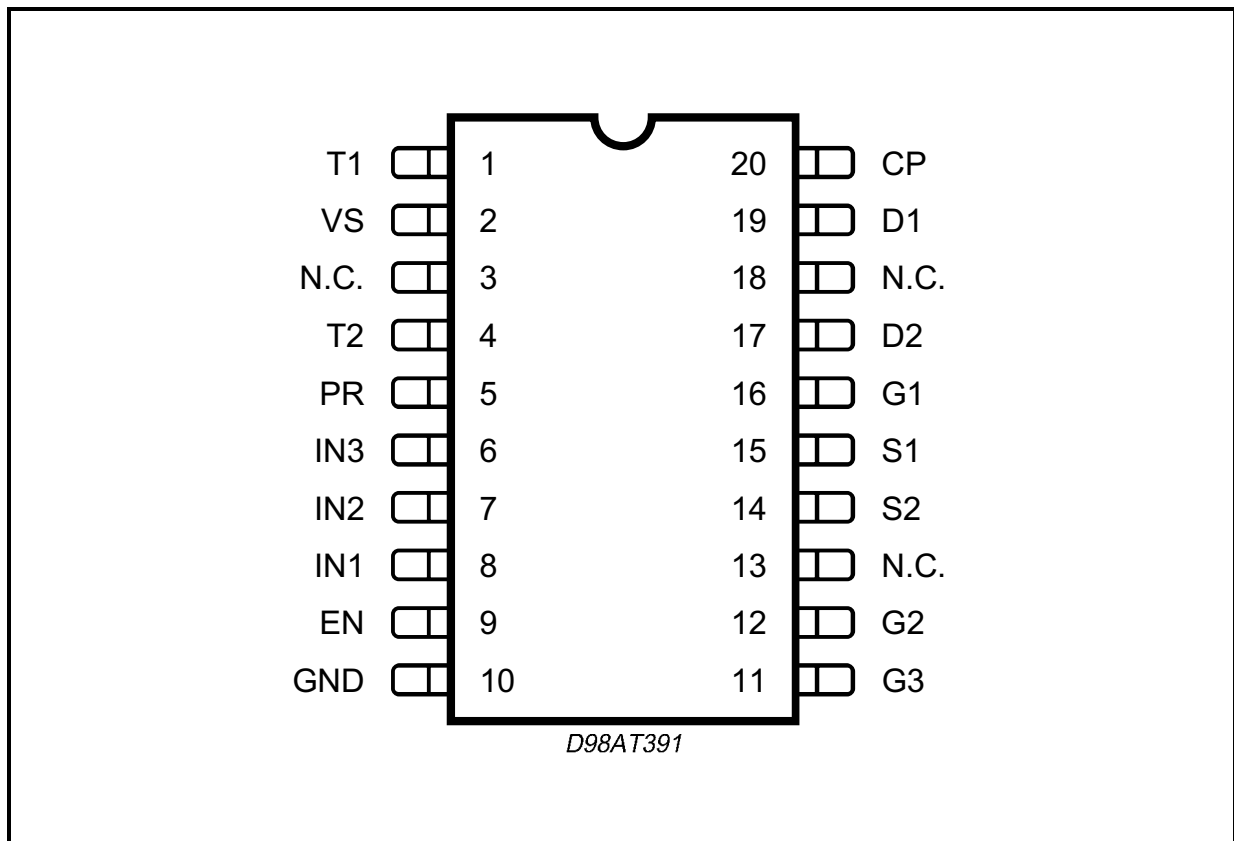

BLOCK DIAGRAM

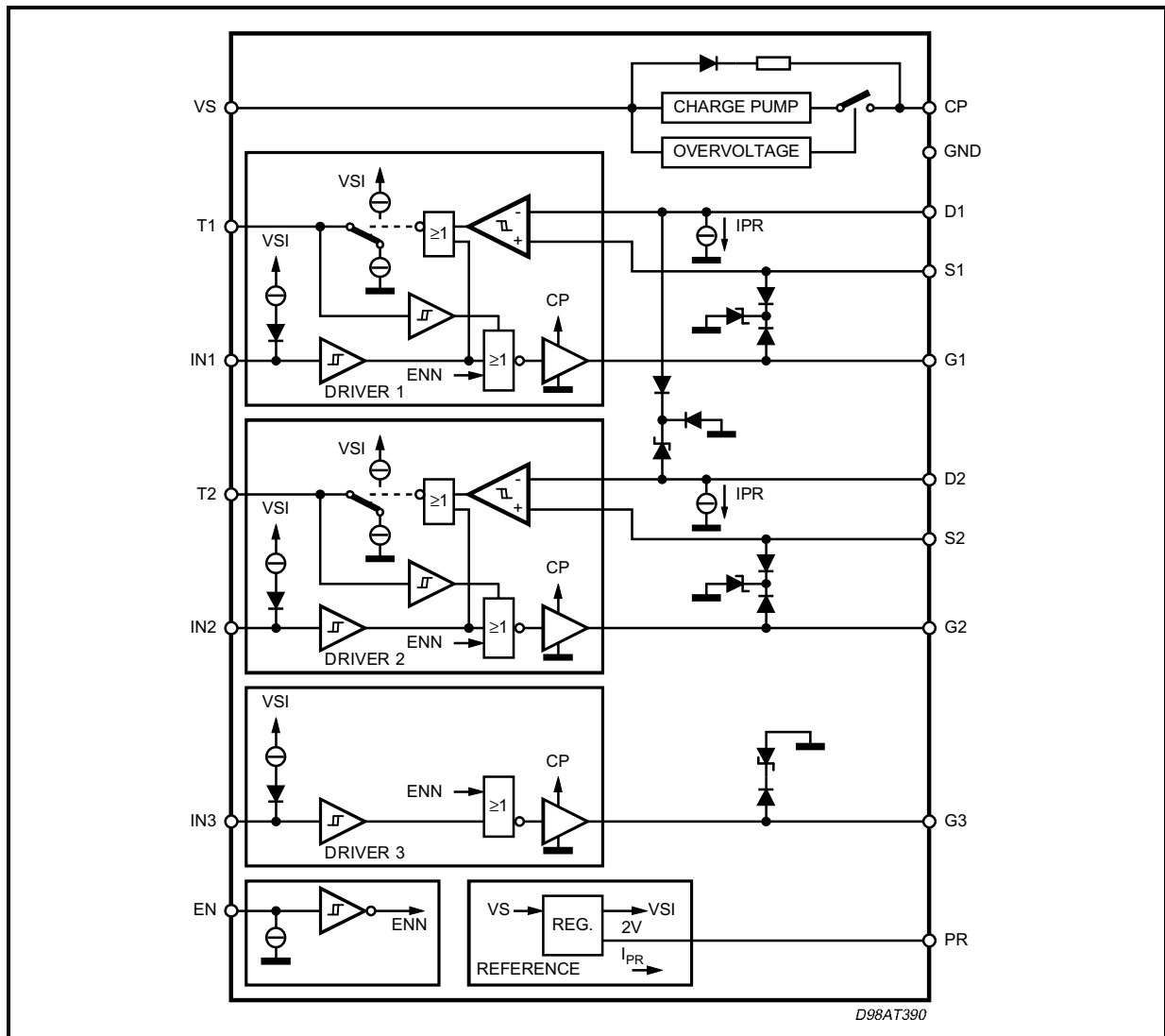

ABSOLUTE MAXIMUM RATINGS

Symbol	Parameter	Value	Unit
$V_S$	DC Supply Voltage	-0.3 to +27	V
$V_S$	Supply Voltage pulse ( $t \leq 400\text{ms}$ )	45	V
$\Delta V_S/dt$	Supply Voltage slope	-10 to +10	V/ $\mu\text{s}$
$V_{IN,EN}$	Input / Enable Voltage	-0.3 to +7	V
$V_T$	Timer Voltage	-0.3 to 27	V
$V_{D,G,S}$	Drain, gate, source voltage	-15 to +27	V
$V_{D,G,S}$	Drain, gate, source voltage pulse ( $t \leq 400\text{ms}$ )	45	V
$I_{D,G,S}$	Drain, gate, source current ( $t \leq 2\text{ms}$ )	0 to +4	mA
$T_j$	Operating Junction Temperature	-40 to 150	$^{\circ}\text{C}$
$T_{stg}$	Storage Temperature	-65 to 150	$^{\circ}\text{C}$

Note: ESD for all pins, except the timer pins, are according to MIL 883C, tested at 2KV, corresponds to a maximum energy dissipation of 0.2mJ. The timer pins are tested with 800V

## THERMAL DATA

Symbol	Parameter	Value	Unit
$R_{th\ j-amb}$	Thermal Resistance Junction to Ambient	100	°C/W

## LIFETIME

Symbol	Parameter	Condition	Value	Unit
$t_B$	Useful life time	$V_S = 0V$	20	years
$t_b$	Operating life time	$V_S = 7$ to $18.5V$	5000	hours

## PIN FUNCTIONS

N.	Name	Function
1	T1	Timer capacitor; the capacitor defines the time for the channel 1 shut down, after overload of the external MOS transistor has been detected.
2	$V_S$	Supply Voltage.
4	T2	Timer capacitor; the capacitor defines the time for the channel 2 shut down, after overload of the external MOS transistor has been detected.
5	PR	Programming resistor for overload detection threshold; the resistor from this pin to ground defines the drain pin current and the charging of the timer capacitor.
6	IN3	Input 3; equal to IN1.
7	IN2	Input 2; equal to IN1.
8	IN1	Input 1; logic signal applied to this pin controls the driver 1; this pin features a current source to assure defined high status when the pin is open.
9	EN	Enable logic signal high on this pin enables all channels
10	GND	Ground
11	G3	Gate 3 driver output; current source from CP or ground
12	G2	Gate 2 driver output; current source from CP or ground
14	S2	Source 2 sense input; monitors the source voltage.
15	S1	Source 1 sense input; monitors the source voltage.
16	G1	Gate 1 driver output; current source from CP or ground
17	D2	Drain 2 sense input; a programmable input bias current defines the drop across the external resistor $R_{D1}$ ; this drop fixes the overload threshold of the external MOS.
19	D1	Drain 1 sense input; a programmable input bias current defines the drop across the external resistor $R_{D1}$ ; this drop fixes the overload threshold of the external MOS.
20	CP	Charge pump capacitor; a alternating current source at this pin charges the connected capacitor $C_{CP}$ to a voltage 10V higher than $V_S$ ; the charge stored in this capacitor is then used to charge all the three gates of the power MOS transistors.
3, 13, 18	NC	Not connected

**ELECTRICAL CHARACTERISTICS** ( $7V \leq V_S \leq 18.5V$ ;  $-40^\circ C \leq T_J \leq 150^\circ C$ , unless otherwise specified.)

Symbol	Parameter	Test Condition	Min.	Typ.	Max.	Unit
<b>SUPPLY</b>						
$I_{VS}$	Static Operating Supply Current	$V_S = 14V$			2.5	mA
<b>CHARGE PUMP</b>						
$V_{CP}$	Charge Pump Voltage Above $V_S$		8		17	V
$t_{CP}$	Charging Time	$V_{CP} = V_S + 8V$ $C_{CP} = 100pF$			200	$\mu s$
$V_{SCP\ off}$	Overvoltage Shut down		20		30	V
$V_{SCP\ hys}$	Overvoltage Shut down Hysteresis <sup>1)</sup>		50	200	1000	mV
$f_{CP}$	Charge Pump frequency <sup>1)</sup>		100	250	400	KHz
<b>GATE DRIVERS</b>						
$I_{GSo}$	Gate Source Current	$V_G = V_S$	-5	-3	-1	mA
$I_{GSi}$	Gate Sink Current	$V_G \geq 0.8V$	1	3	5	mA
<b>DRAIN - SOURCE SENSING</b>						
$V_{PR}$	Bias Current Programming voltage	$10\mu A \leq I_{PR} \leq 100\mu A$ ; $V_D \geq 4V$	1.8	2	2.2	V
$I_{D\ Leak}$	Drain pin leakage current	$V_S = 0V$ ; $V_D = 14V$	0		5	$\mu A$
$I_D$	Drain pin bias current	$V_S \geq V_D + 1V$ ; $V_D \geq 5V$	$0.9 I_{PR}$		$1.1 I_{PR}$	
$I_{Smax}$	Source pin input current	$V_S \geq V_D + 1V$ ; $V_D \geq 7V$	10		60	$\mu A$
$V_{HYST}$	Comparator Hysteresis			20		mV
<b>TIMER</b>						
$V_{THi}$	Timer threshold high		4	4.4	4.8	V
$V_{TL0}$	Timer threshold low		0.3	0.4	0.5	V
$I_T$	Timer Current	$I_N = 5V$ ; $V_T = 2V$ $I_N = 0V$ ; $V_S < V_D$ ; $V_D \geq 5V$ ; $V_T = 2V$	$0.4 I_{PR}$ $-0.6 I_{PR}$		$0.6 I_{PR}$ $-0.4 I_{PR}$	
<b>INPUTS</b>						
$V_{LOW}$	Input Enable low voltage		-0.3		1	V
$V_{HIGH}$	Input Enable high voltage		3		7	V
$V_{INhys}$	Input Enable Hysteresis <sup>(1)</sup>		50	200	500	mV
$I_{IN}$	Input source current	$V_{IN} \leq 3V$	-30		-5	$\mu A$
$I_{EN}$	Enable sink current	$V_{EN} \geq 1V$	5		30	$\mu A$
$t_d$	Transfer time IN/ENABLE	$V_S = 14V$ $V_G = V_S$ ; OPEN GATE			2.5	$\mu s$

NOTE: Not measured guaranteed by design

Function is given for supply voltage down to 5.5V. Function means: The channels are controlled from the inputs, some other parameters may exceed the limit. In this case the programming voltage and timer threshold will be lower. This leads to a lower protection threshold and time.

**FUNCTIONAL DESCRIPTION**

The Triple High-Side Power-MOS Driver features all necessary control and protection functions to switch on three Power-MOS transistors operating as High-Side switches in automotive electronic control units. The key application field is relays replacement in systems where high current loads, usually motors with nominal currents of about 40A connected to ground, has to be switched.

A high signal at the EN pin enables all three channels. With enable low gates are clamped to ground. In this condition the gate sink current is higher than the specified 3mA. An enable low sig-

nal makes also a reset of the timer.

A low signal at the inputs switch on the gates of the external MOS. A short circuit at the input leads to permanent activation of the concerned channel. In this case the device can be disabled with the enable pin. The charge pump loading is not influenced due to the enable input.

An external N-channel MOS driver in high side configuration needs a gate driving voltage higher than  $V_S$ . It is generated by means of a charge pump with integrated charge transfer capacitors and one external charge storage capacitor  $C_{CP}$ . The charge pump is dimensioned to load a ca-

Figure 4. Timing Characteristic.

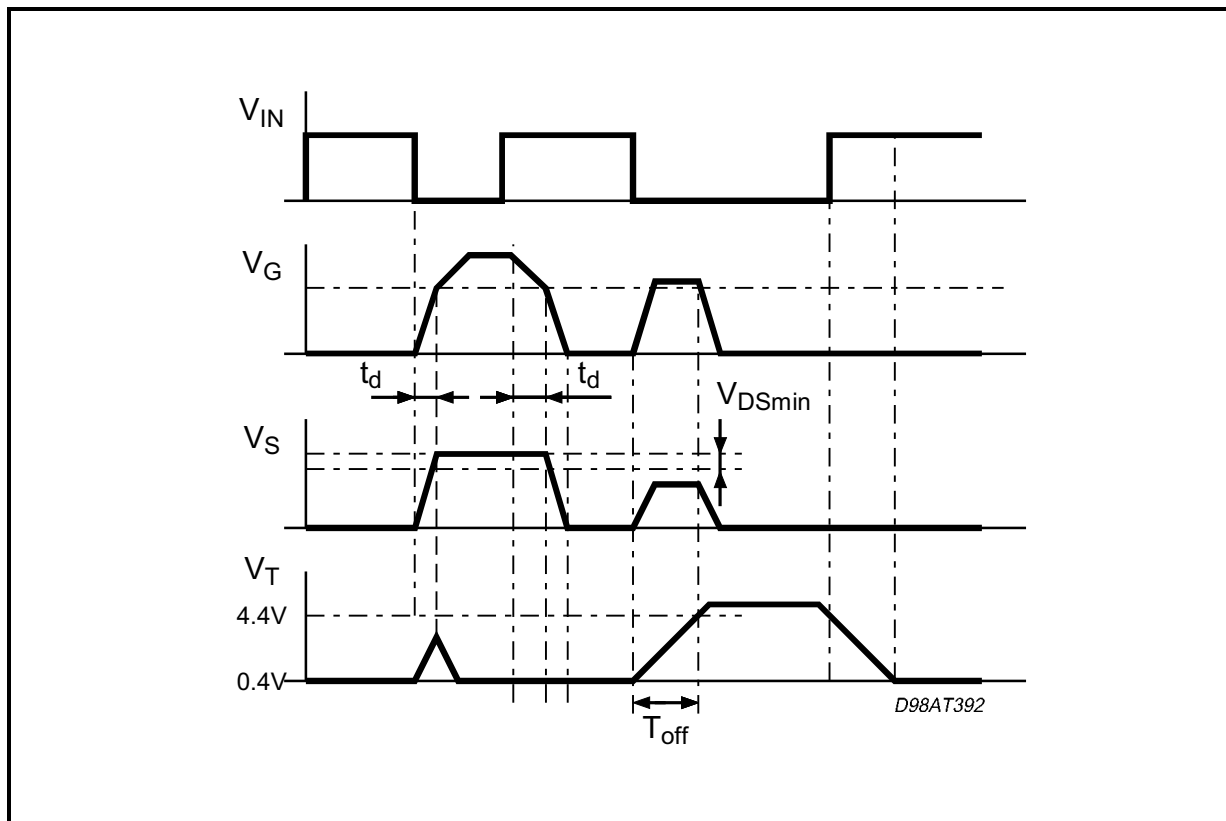

capacitor  $C_{CP}$  of 33nF in less than 20ms up to 8V above  $V_S$ . The value of  $C_{CP}$  depends on the input capacitance of the external MOS and the decay of the charge pump voltage down to that value where no significant influence on the application occurs.

The necessary charging time for  $C_{CP}$  has to be respected in the sequence of the input control signals. As a consequence the lower gate to source voltage can cause a higher drop across the Power-MOS and get into overload condition. In this case the overload protection timer will start. After the protection time the concerned channel will be switched off. Channel 3 is not equipped with an overload protection. The same situation can occur due to a discharge of the storage capacitor caused by the gate short to ground. The gate driver that is supplied from the pin CP, which is the charge pump output, has a sink and source current capability of 3mA. For a short-circuit of the load (source to ground) the L9380 has no gate to source limitation. The gate source protection must be done externally.

Channel 1 and 2 provide drain to source voltage sensing possibility with programmable shut-off delay when the activation threshold was exceeded. This threshold  $V_{DSmin}$  is set by the external resistor  $R_D$ . The bias current flowing through this resistor is determined by the programming re-

Figure 5. Drain, source input current.

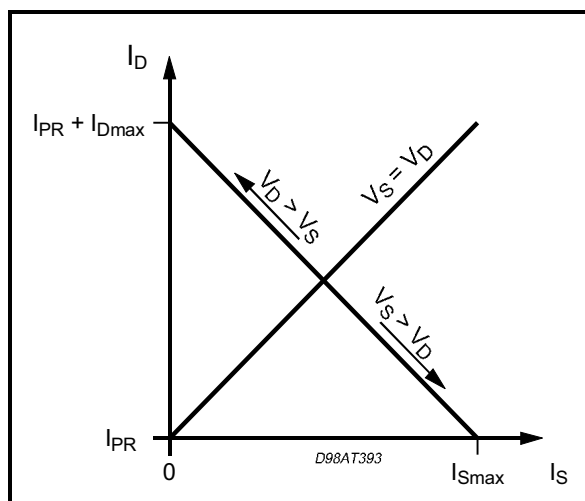

sistor  $R_{PR}$ . This external resistor  $R_{PR}$  defines also the charge and discharge current of the timer capacitor  $C_{CT}$ . The drain to source threshold  $V_{DSmin}$  and the timer shut off delay time  $T_{off}$  can be calculated:

$$V_{DSmin} = V_{PR} (R_D / R_{PR})$$

$$T_{off} = 4.4 C_T R_{PR}$$

In application which don't use the overload protection or if one channel is not used, the Timer pin of this channel must be connected to ground and the drain pin with a resistor to  $V_{bat}$ .

The timing characteristic illustrates the function and the meaning of  $V_{DSmin}$  and  $T_{off}$  (see figure 4).

The input current of the overload sense comparator is specified as  $I_{Smax}$ . The sum  $I_{PR} + I_{Dmax}$  generates a drop across the external resistor  $R_D$  if the drain pin voltage is higher than the source pin (see Fig. 5). In the switching point the comparator input source pin currents are equal and the half of the specified current  $I_{Smax}$ . For an offset compensation equal external resistors ( $R_D = R_S$ ) at drain and source pin are imperative. The drain sense comparator, which detects the overload, has a symmetrical hysteresis of 20mV (see Fig. 6). Exceeding the source pin voltage by 10mV with respect to the drain voltage forces the timer capacitor to discharge. Decreasing the source pin voltage 10mV lower than the drain pin voltage an overload of the external MOS is detected and the timer capacitor will be loaded. After reaching a voltage at pin CT higher than the timer threshold  $V_{Thi}$  the influenced channel is switched off. In this case the overload is stored in the timer capacitor. The timer capacitor will be discharged with a 'High' signal at the input (see Fig. 4). After reaching the lower timer threshold  $V_{TL0}$  the overload protection is reset and the channel is able to switch on again.

The application diagram is shown in Fig. 7. Because of the transients present at the power lines during operation and possible disturbances in the system the external resistors are necessary.

Positive ISO-Pulses at Drain, Gate Source are clamped with an active clamping structure. The clamping voltage is less than 60V. Negative Pulses are only clamped with the ESD-Structure less than -15V. This transients lower than -15V can influence the other channels.

In order to protect the transistor against overload and gate breakdown protection diodes between gate and source and gate and drain has to be connected. In case of overvoltage into  $V_S$  ( $V_S > 20V$ ) the charge pump oscillation is stopped.

Then the charge pump capacitor will be loaded by

Figure 6. Comparator hysteresis.

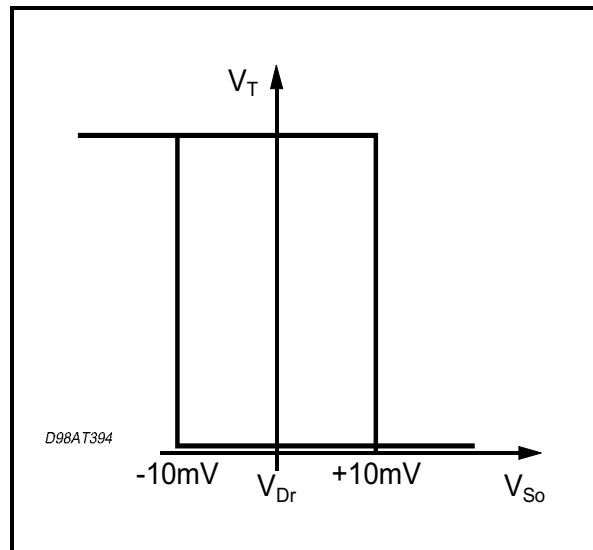

a diode and a resistor in series up to  $V_S$  (see Block Diagram). In this case the channels are not influenced. In reverse battery condition the pins D1, D2, S1, S2 follow the battery potential down to -13V (high impedance) and the gate driver pins G1, G2 is referred to S1, S2. In this way it is assured that M1 and M2 will not be driven into the linear conductive mode. This protection function is operating for  $V_{S1}, V_{S2}$  down to -15V. The gate driver output G3 is referred to the D1 in this case. This function guarantees that the source to source connected N-Channel MOS transistors M3 and M4 remains OFF.

All the supplies and the in- and output of the PC-Board are supplied with a 40 wires flat cable (not used wires are left open). This cable is submitted to the RF in the strip-line like described in DIN 40839-4 or ISO 11456-5.

The measured circuit was build up on a PCB board with ground plane. In the frequency range from 1MHz to 400MHz and 80% AM-modulation of 1KHz with field strength of 200V/m no influence to the basic function was detected on a typical device. The failure criteria is an envelope of the output signal with 20% in the amplitude and 2% in the time.

Figure 7. Application Circuit.

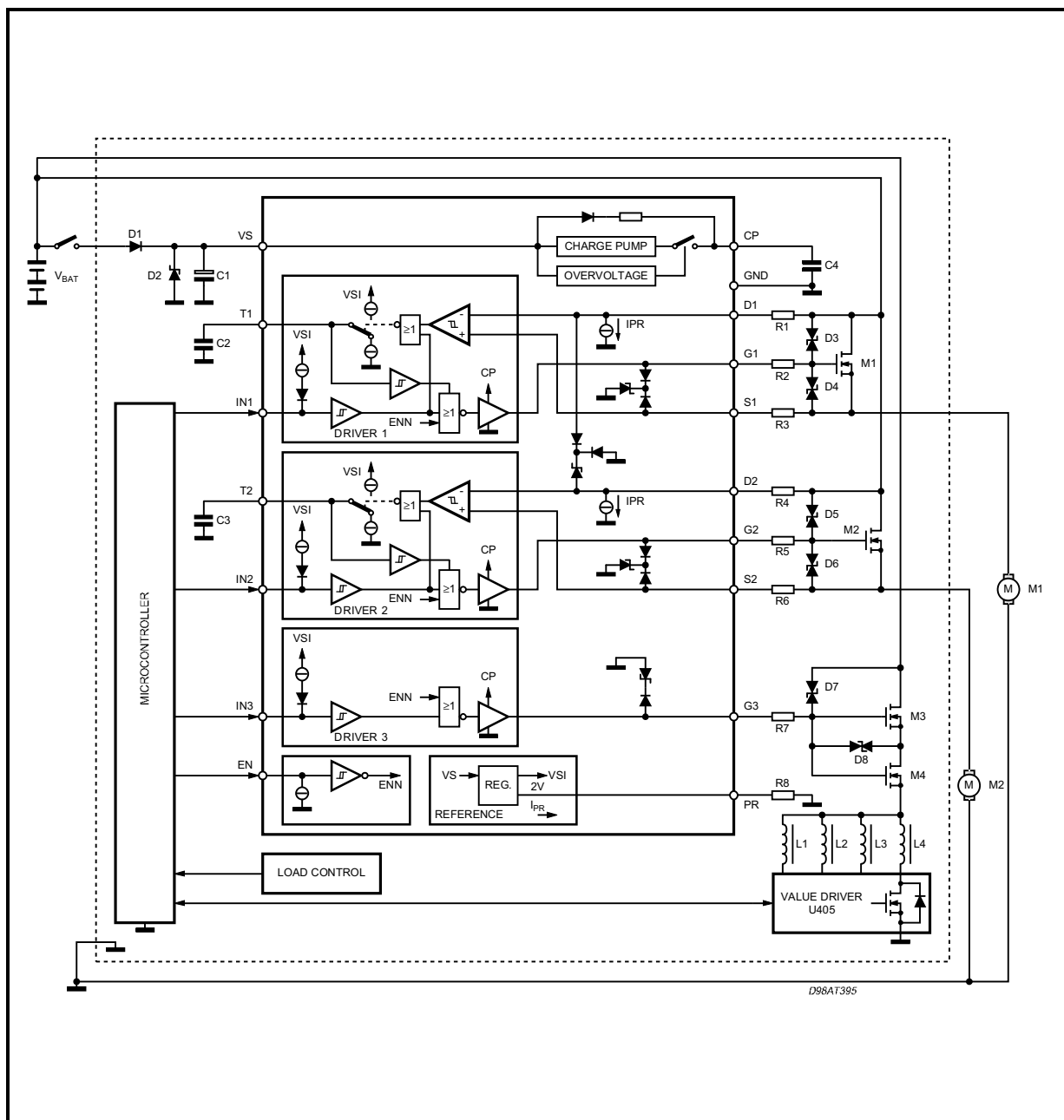

Recommendations to the application circuit: The timer and the charge capacitors are loaded with an alternating current source. A short ground connection of the charge capacitor is indispensable to avoid electromagnetic emissions. The dimension of the resistors RD, RG and RS have to respect the maximum current during transients at each pin.

**TYPICAL CHARACTERISTICS**

Depending on production spread, certain deviations may occur. For limits (see pag. 4)

**Figure 8.** Charge Loading Time as function of  $V_S$   
( $V_{CP} = 8V + V_S$ )

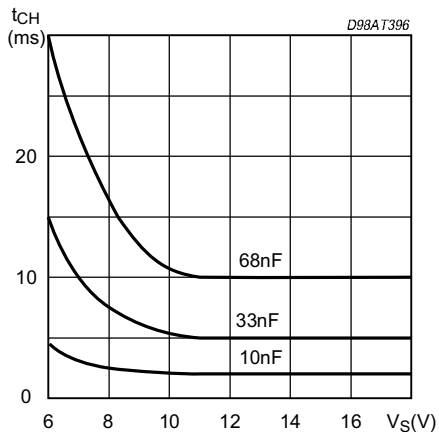

**Figure 9.** Charge Pump Current as function of the Charge Voltage

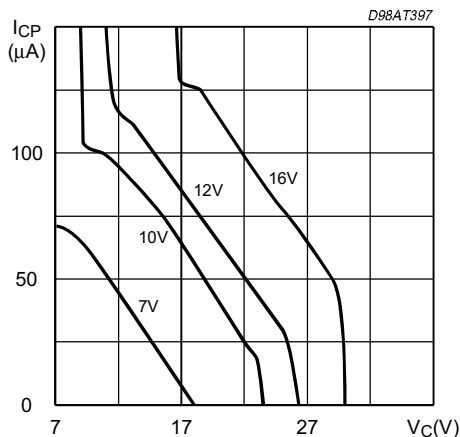

**Figure 10.** Ground Loss Protection Gate Discharge Current for Source Voltage

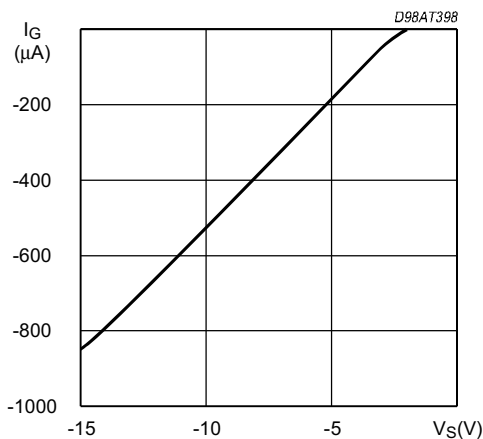

**Figure 11.** Input Current as function of the Input Voltage

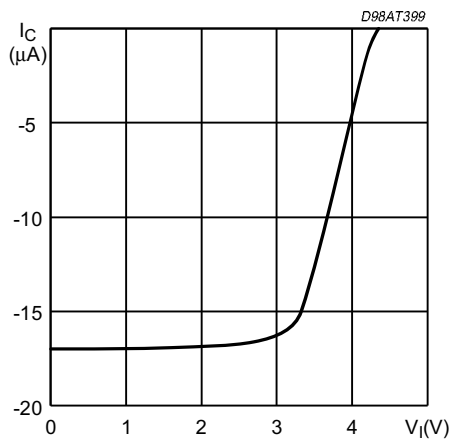

**Figure 12.** Overvoltage Shutdown of the Charge Pump with Hysteresis

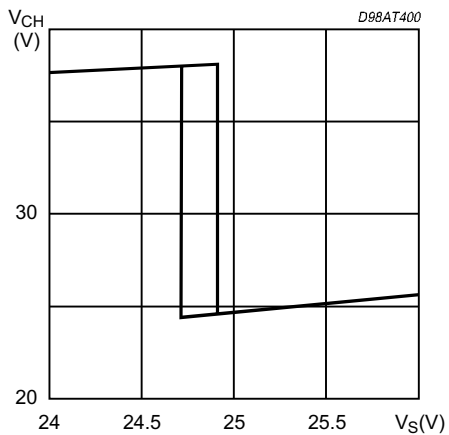



**Figure 13.** Measured Circuit.

The EMS of the device was verified in the below described setup.

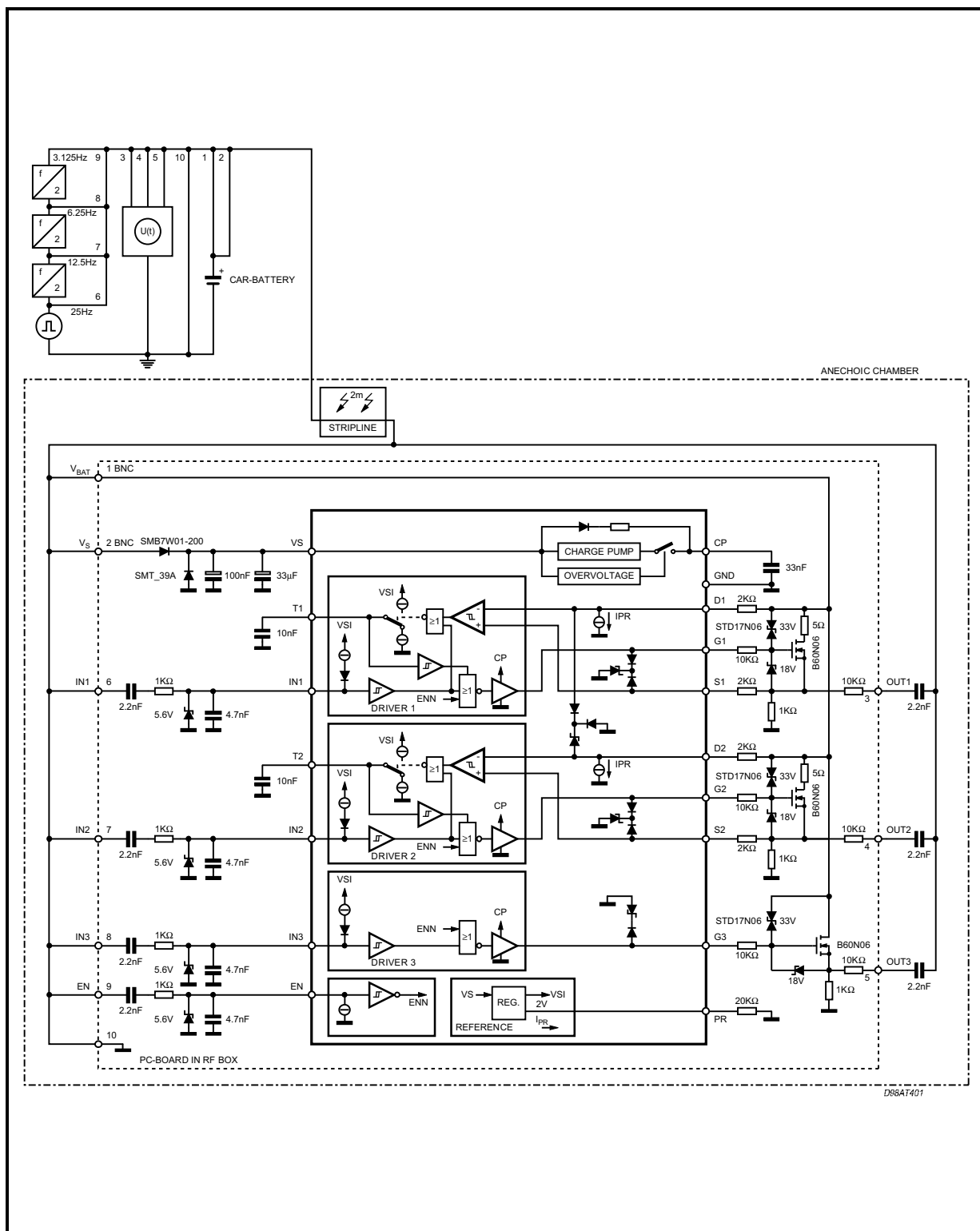
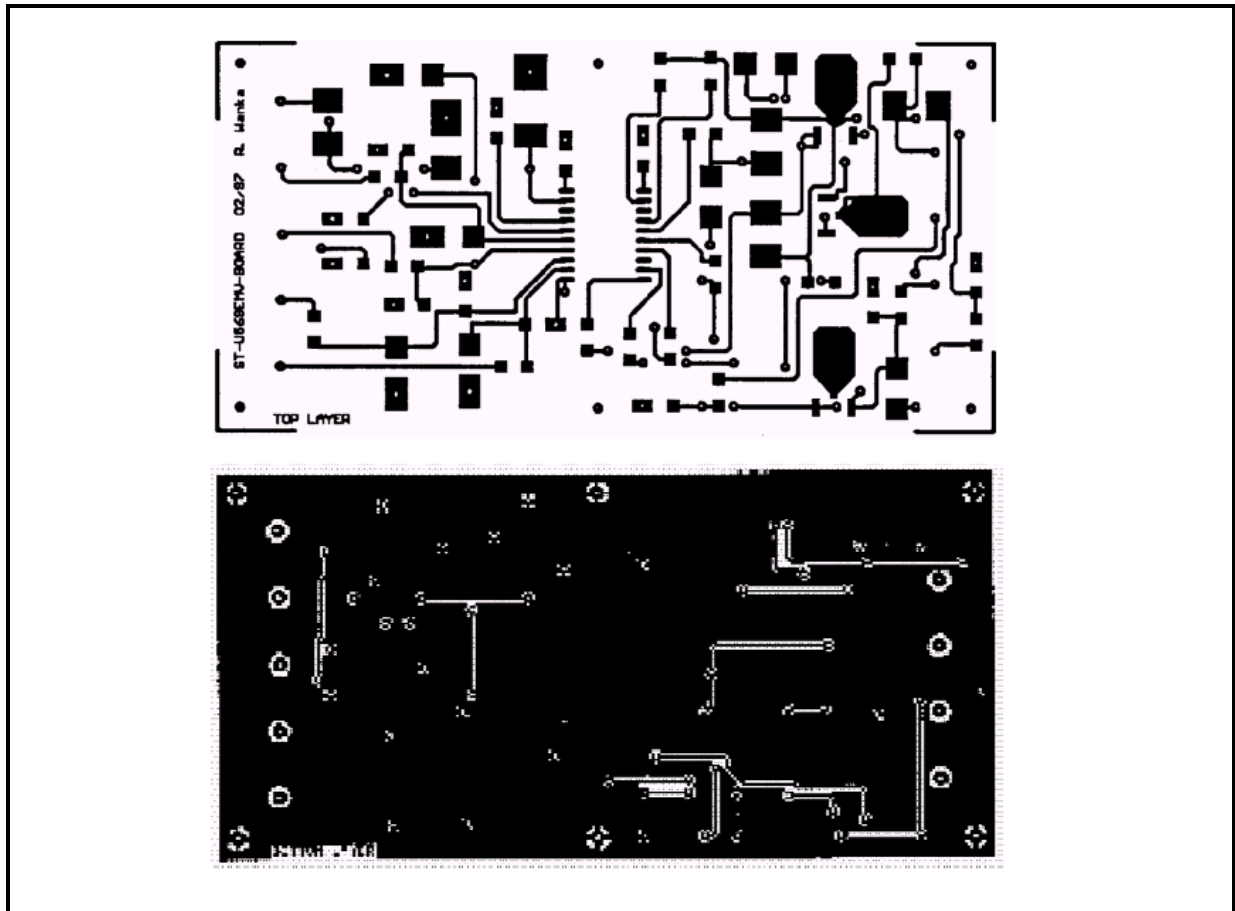

Figure 14: PCB Board



**Electromagnetic Emission Classification (EME)**

Electromagnetic Emission classes presented below are typical data found on bench test. For details test description please refer to "Electromagnetic Emission (EME) Measurement of Integrated Circuits, DC to 1GHz" of VDE/ZVEI work group 767.13 and VDE/ZVEI work group 767.14 or IEC project number 47A 1967Ed. This data is targeted to board designers to allow an estimation of emission filtering effort required in application. All measurements are done with the EMS-board (See pages 9, 10)

Pin	EME class			Remark
VCP	G	-	w	

Electromagnetic Emission and Susceptivity is not tested in production.

## SO20 PACKAGE MECHANICAL DATA

DIM.	mm			inch		
	MIN.	TYP.	MAX.	MIN.	TYP.	MAX.
A	2.35		2.65	0.093		0.104
A1	0.1		0.3	0.004		0.012
B	0.33		0.51	0.013		0.020
C	0.23		0.32	0.009		0.013
D	12.6		13	0.496		0.512
E	7.4		7.6	0.291		0.299
e		1.27			0.050	
H	10		10.65	0.394		0.419
h	0.25		0.75	0.010		0.030
L	0.4		1.27	0.016		0.050
K	0 (min.)8 (max.)					

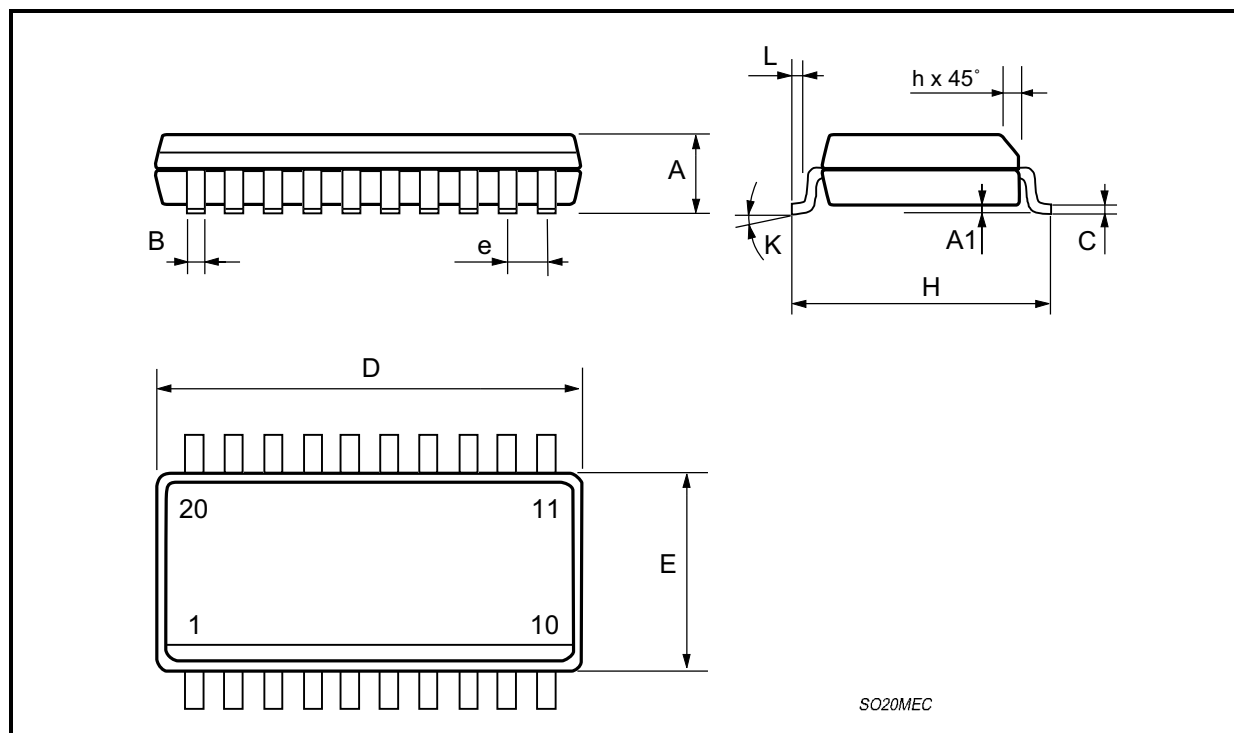

Information furnished is believed to be accurate and reliable. However, SGS-THOMSON Microelectronics assumes no responsibility for the consequences of use of such information nor for any infringement of patents or other rights of third parties which may result from its use. No license is granted by implication or otherwise under any patent or patent rights of SGS-THOMSON Microelectronics. Specification mentioned in this publication are subject to change without notice. This publication supersedes and replaces all information previously supplied. SGS-THOMSON Microelectronics products are not authorized for use as critical components in life support devices or systems without express written approval of SGS-THOMSON Microelectronics.

© 1998 SGS-THOMSON Microelectronics – Printed in Italy – All Rights Reserved

SGS-THOMSON Microelectronics GROUP OF COMPANIES

Australia - Brazil - Canada - China - France - Germany - Italy - Japan - Korea - Malaysia - Malta - Morocco - The Netherlands -  
Singapore - Spain - Sweden - Switzerland - Taiwan - Thailand - United Kingdom - U.S.A.