

Complementary Power Darlingtons

For Isolated Package Applications

Designed for general-purpose amplifiers and switching applications, where the mounting surface of the device is required to be electrically isolated from the heatsink or chassis.

- Electrically Similar to the Popular TIP122 and TIP127
- 100 V_{CEO(sus)}
- 5 A Rated Collector Current
- No Isolating Washers Required
- Reduced System Cost
- High DC Current Gain — 2000 (Min) @ I_C = 3 A_{dc}
- UL Recognized, File #E69369, to 3500 V_{RMS} Isolation

MAXIMUM RATINGS

Rating	Symbol	Value	Unit
Collector–Emitter Voltage	V _{CEO}	100	Vdc
Collector–Base Voltage	V _{CB}	100	Vdc
Emitter–Base Voltage	V _{EB}	5	Vdc
RMS Isolation Voltage (1) (for 1 sec, R.H. < 30%, T _A = 25°C)	Test No. 1 Per Fig. 14 Test No. 2 Per Fig. 15 Test No. 3 Per Fig. 16 V _{ISOL}	4500 3500 1500	V _{RMS}
Collector Current — Continuous Peak	I _C	5 8	A _{dc}
Base Current	I _B	0.12	A _{dc}
Total Power Dissipation* @ T _C = 25°C Derate above 25°C	P _D	30 0.24	Watts W/°C
Total Power Dissipation @ T _A = 25°C Derate above 25°C	P _D	2 0.016	Watts W/°C
Operating and Storage Junction Temperature Range	T _J , T _{stg}	–65 to +150	°C

THERMAL CHARACTERISTICS

Characteristic	Symbol	Max	Unit
Thermal Resistance, Junction to Ambient	R _{θJA}	62.5	°C/W
Thermal Resistance, Junction to Case*	R _{θJC}	4.1	°C/W
Lead Temperature for Soldering Purpose	T _L	260	°C

*Measurement made with thermocouple contacting the bottom insulated mounting surface (in a location beneath the die), the device mounted on a heatsink with thermal grease and a mounting torque of ≥ 6 in. lbs.
(1) Proper strike and creepage distance must be provided.

NPN
MJF122
PNP
MJF127

COMPLEMENTARY
SILICON
POWER DARLINGTONS
5 AMPERES
100 VOLTS
30 WATTS

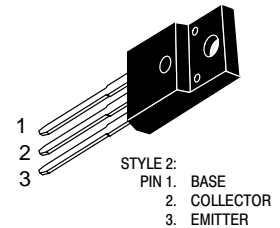

CASE 221D-02
TO-220 TYPE

MJF122 MJF127

ELECTRICAL CHARACTERISTICS ($T_C = 25^\circ\text{C}$ unless otherwise noted)

Characteristic	Symbol	Min	Max	Unit
OFF CHARACTERISTICS				
Collector–Emitter Sustaining Voltage (1) ($I_C = 100\text{ mA}$, $I_B = 0$)	$V_{CE(sus)}$	100	—	Vdc
Collector Cutoff Current ($V_{CE} = 50\text{ Vdc}$, $I_B = 0$)	I_{CEO}	—	10	μA
Collector Cutoff Current ($V_{CB} = 100\text{ Vdc}$, $I_E = 0$)	I_{CBO}	—	10	μA
Emitter Cutoff Current ($V_{BE} = 5\text{ Vdc}$, $I_C = 0$)	I_{EBO}	—	2	mA
ON CHARACTERISTICS (1)				
DC Current Gain ($I_C = 0.5\text{ Adc}$, $V_{CE} = 3\text{ Vdc}$) ($I_C = 3\text{ Adc}$, $V_{CE} = 3\text{ Vdc}$)	h_{FE}	1000 2000	—	—
Collector–Emitter Saturation Voltage ($I_C = 3\text{ Adc}$, $I_B = 12\text{ mA}$) ($I_C = 5\text{ Adc}$, $I_B = 20\text{ mA}$)	$V_{CE(sat)}$	—	2 3.5	Vdc
Base–Emitter On Voltage ($I_C = 3\text{ Adc}$, $V_{CE} = 3\text{ Vdc}$)	$V_{BE(on)}$	—	2.5	Vdc
DYNAMIC CHARACTERISTICS				
Small–Signal Current Gain ($I_C = 3\text{ Adc}$, $V_{CE} = 4\text{ Vdc}$, $f = 1\text{ MHz}$)	h_{fe}	4	—	—
Output Capacitance ($V_{CB} = 10\text{ Vdc}$, $I_E = 0$, $f = 0.1\text{ MHz}$)	MJF127 MJF122 C_{ob}	—	300 200	pF

(1) Pulse Test: Pulse Width $\leq 300\ \mu\text{s}$, Duty Cycle $\leq 2\%$.

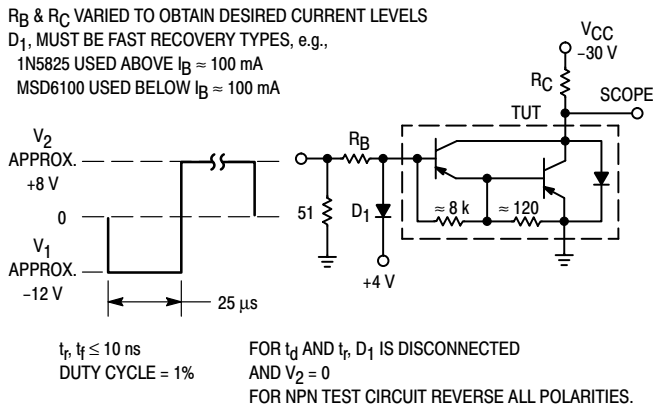

Figure 1. Switching Times Test Circuit

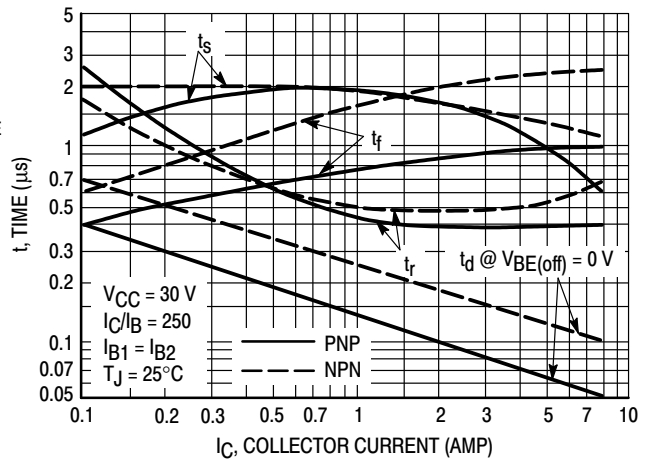

Figure 2. Typical Switching Times

MJF122 MJF127

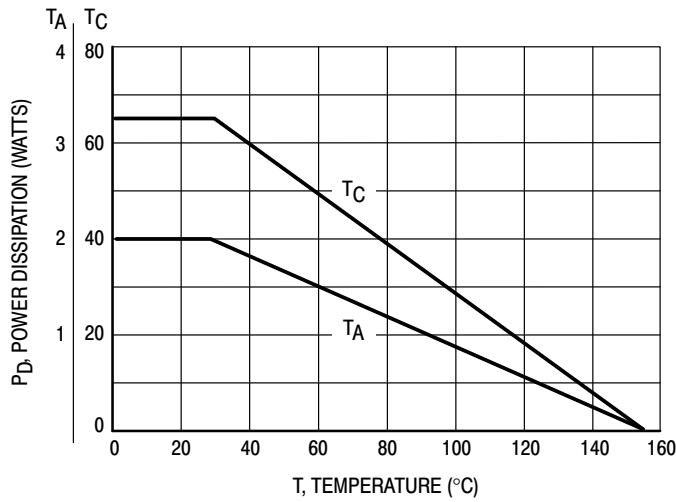

Figure 3. Maximum Power Derating

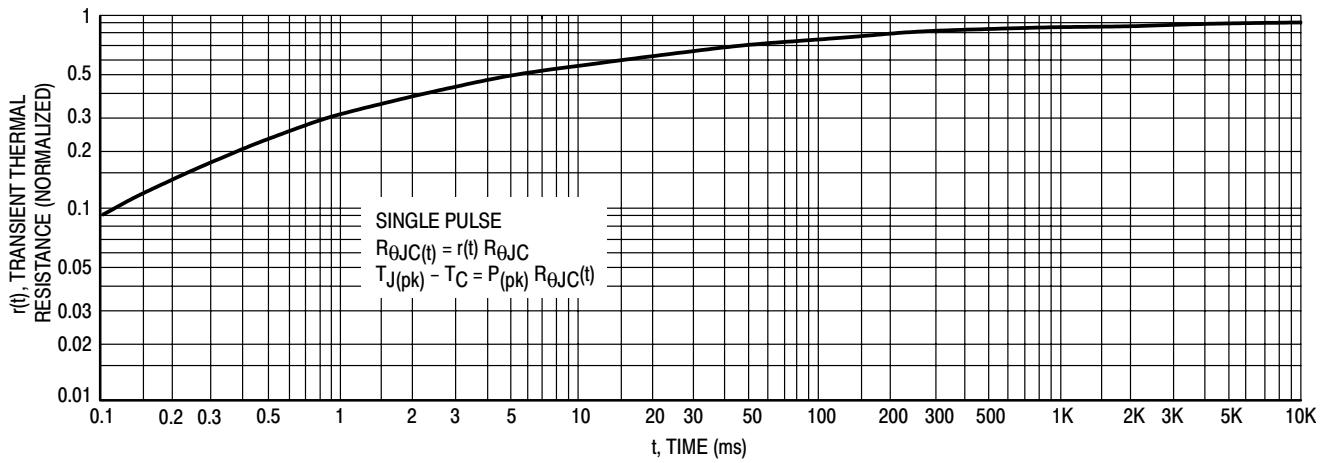

Figure 4. Thermal Response

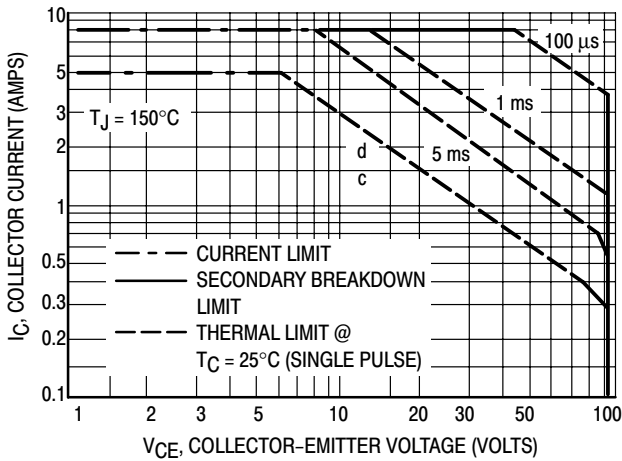

Figure 5. Maximum Forward Bias Safe Operating Area

There are two limitations on the power handling ability of a transistor: average junction temperature and second breakdown. Safe operating area curves indicate $I_C - V_{CE}$ limits of the transistor that must be observed for reliable operation; i.e., the transistor must not be subjected to greater dissipation than the curves indicate.

The data of Figure 5 is based on $T_{J(pk)} = 150^\circ\text{C}$; T_C is variable depending on conditions. Secondary breakdown pulse limits are valid for duty cycles to 10% provided $T_{J(pk)} < 150^\circ\text{C}$. $T_{J(pk)}$ may be calculated from the data in Figure 4. At high case temperatures, thermal limitations will reduce the power that can be handled to values less than the limitations imposed by secondary breakdown.

MJF122 MJF127

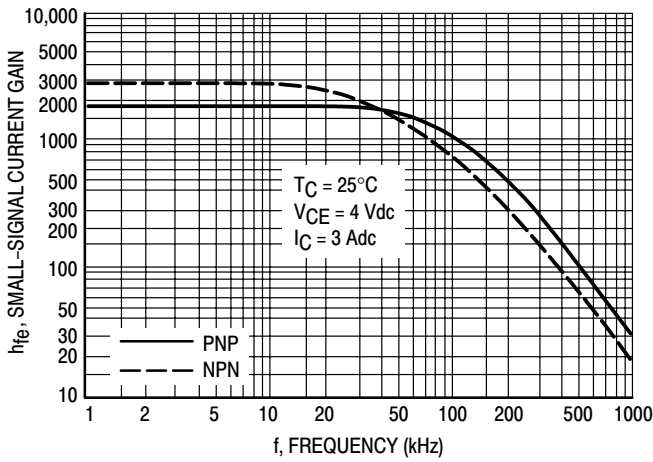

Figure 6. Typical Small-Signal Current Gain

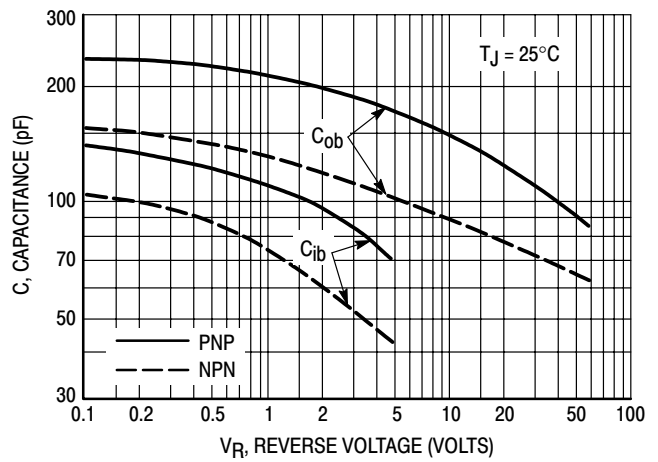

Figure 7. Typical Capacitance

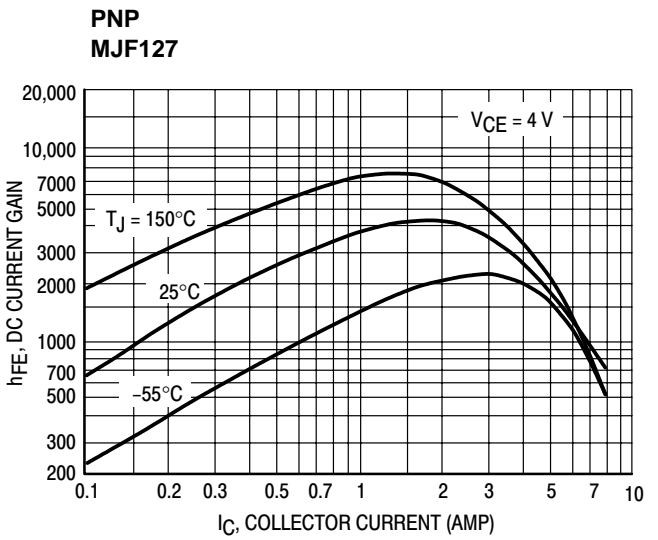
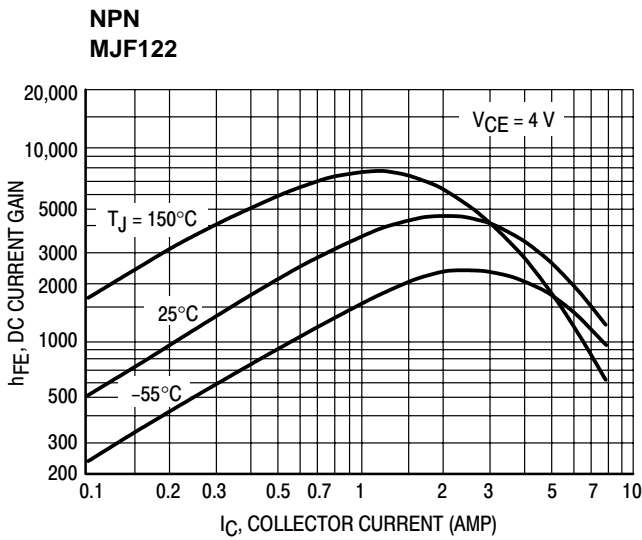

Figure 8. Typical DC Current Gain

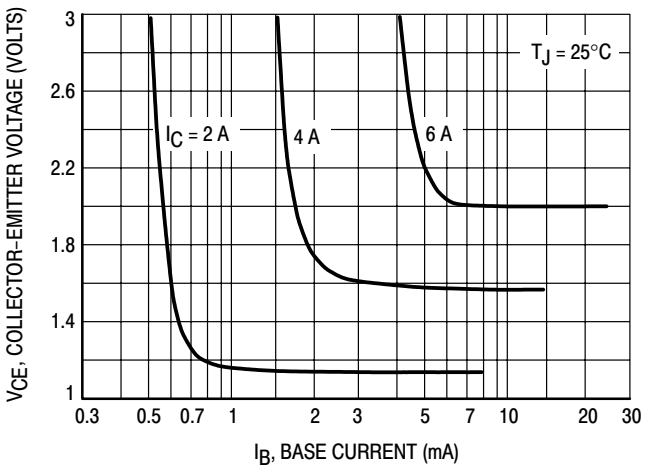
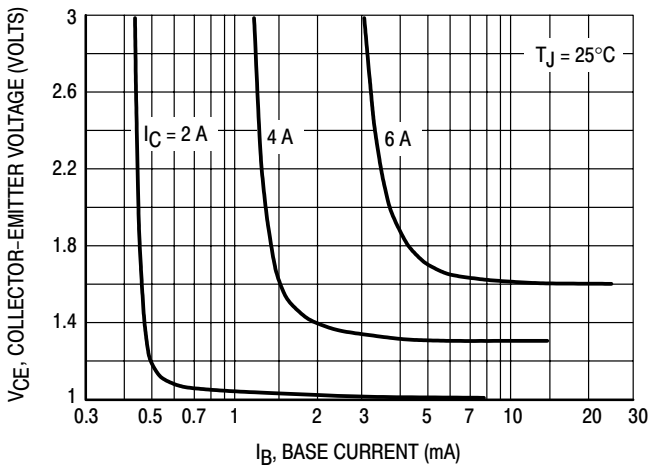
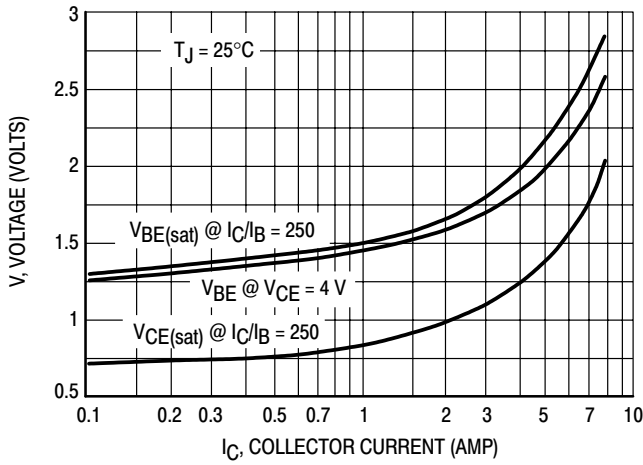

Figure 9. Typical Collector Saturation Region

MJF122 MJF127

**NPN
MJF122**



**PNP
MJF127**

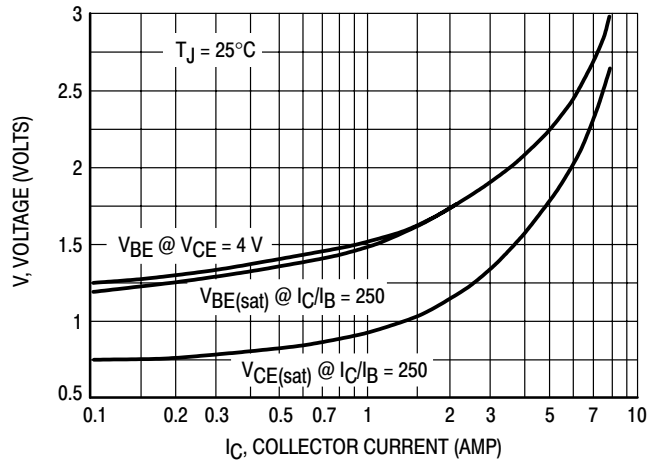

Figure 10. Typical "On" Voltages

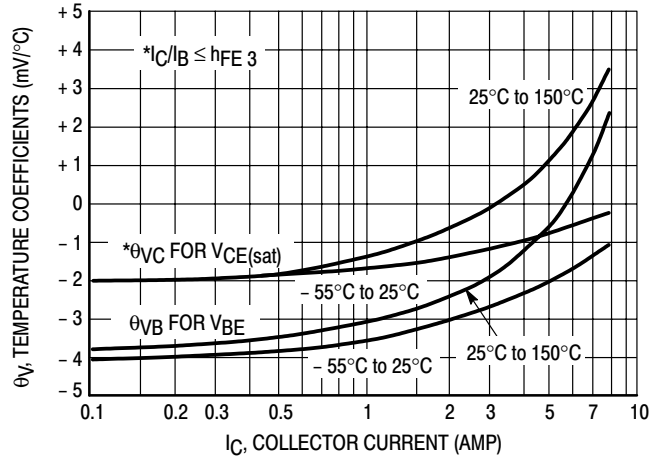
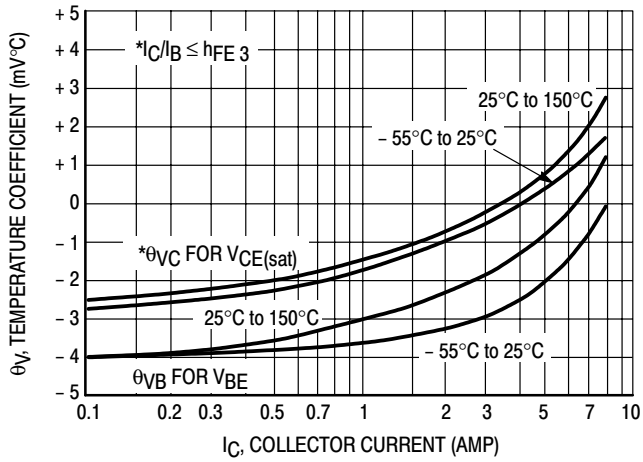

Figure 11. Typical Temperature Coefficients

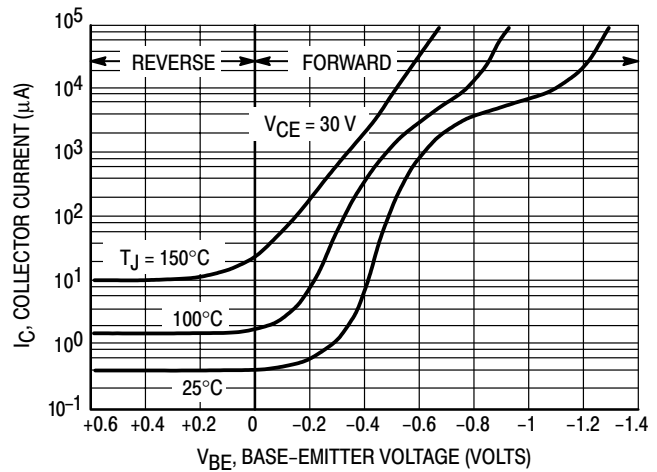
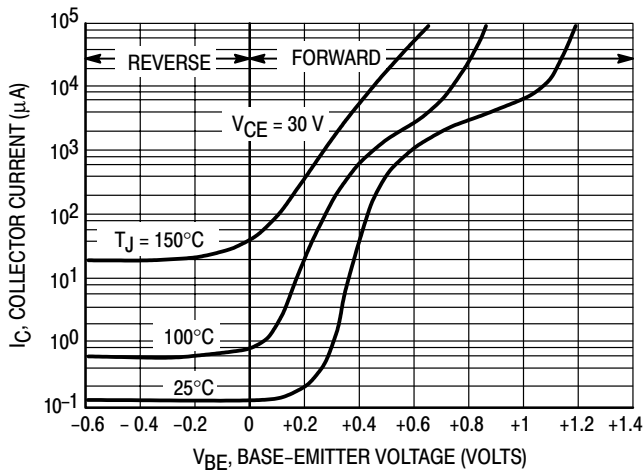
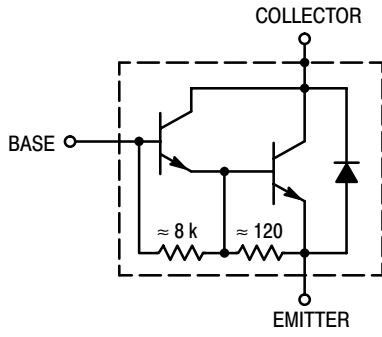

Figure 12. Typical Collector Cut-Off Region

MJF122 MJF127

NPN
MJF122



PNP
MJF127

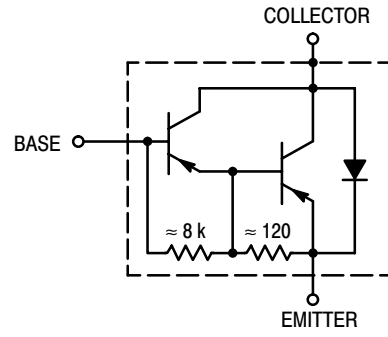

Figure 13. Darlington Schematic

TEST CONDITIONS FOR ISOLATION TESTS*

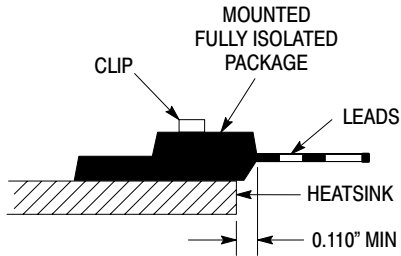

Figure 14. Clip Mounting Position for Isolation Test Number 1

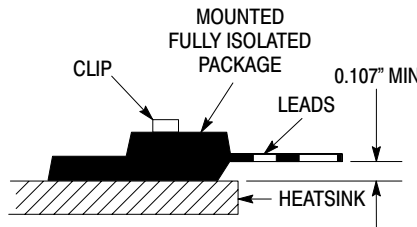

Figure 15. Clip Mounting Position for Isolation Test Number 2

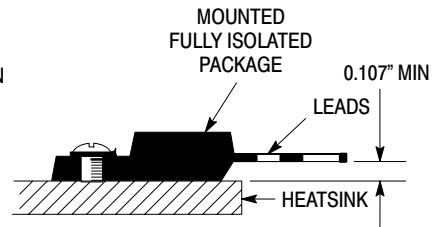

Figure 16. Screw Mounting Position for Isolation Test Number 3

*Measurement made between leads and heatsink with all leads shorted together

MOUNTING INFORMATION

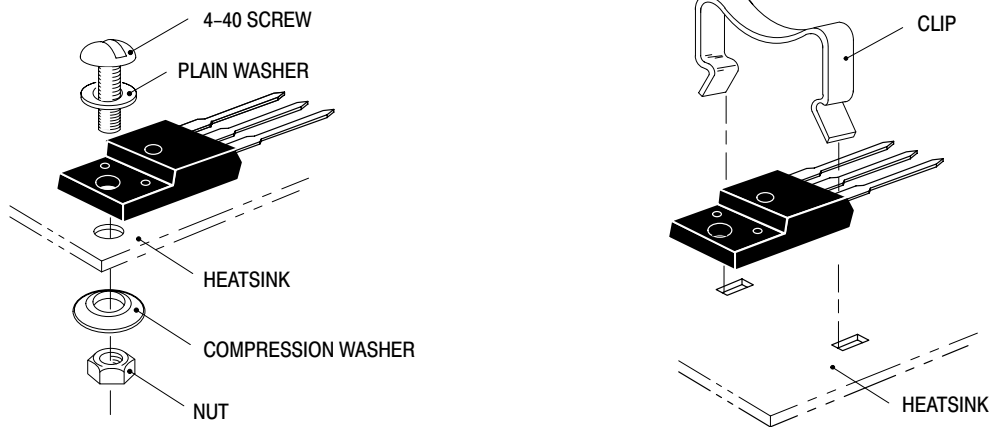

Figure 17. Typical Mounting Techniques*

Laboratory tests on a limited number of samples indicate, when using the screw and compression washer mounting technique, a screw torque of 6 to 8 in · lbs is sufficient to provide maximum power dissipation capability. The compression washer helps to maintain a constant pressure on the package over time and during large temperature excursions.

Destructive laboratory tests show that using a hex head 4-40 screw, without washers, and applying a torque in excess of 20 in · lbs will cause the plastic to crack around the mounting hole, resulting in a loss of isolation capability.

Additional tests on slotted 4-40 screws indicate that the screw slot fails between 15 to 20 in · lbs without adversely affecting the package. However, in order to positively ensure the package integrity of the fully isolated device, ON Semiconductor does not recommend exceeding 10 in · lbs of mounting torque under any mounting conditions.

** For more information about mounting power semiconductors see Application Note AN1040.

MJF122 MJF127

PACKAGE DIMENSIONS

CASE 221D-02 TO-220 TYPE ISSUE D

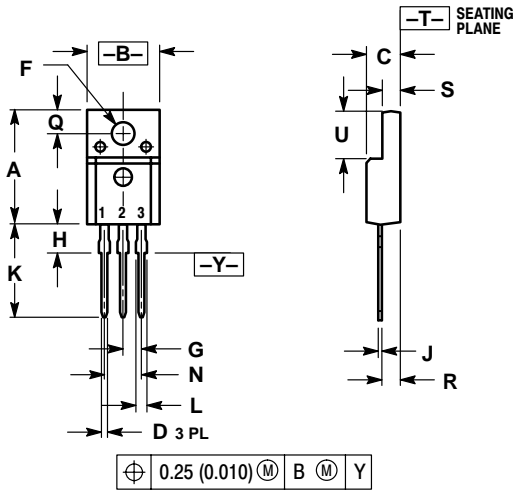

NOTES:

1. DIMENSIONING AND TOLERANCING PER ANSI Y14.5M, 1982.
2. CONTROLLING DIMENSION: INCH.

DIM	INCHES		MILLIMETERS	
	MIN	MAX	MIN	MAX
A	0.621	0.629	15.78	15.97
B	0.394	0.402	10.01	10.21
C	0.181	0.189	4.60	4.80
D	0.026	0.034	0.67	0.86
F	0.121	0.129	3.08	3.27
G	0.100 BSC		2.54 BSC	
H	0.123	0.129	3.13	3.27
J	0.018	0.025	0.46	0.64
K	0.500	0.562	12.70	14.27
L	0.045	0.060	1.14	1.52
N	0.200 BSC		5.08 BSC	
Q	0.126	0.134	3.21	3.40
R	0.107	0.111	2.72	2.81
S	0.096	0.104	2.44	2.64
U	0.259	0.267	6.58	6.78

STYLE 2:

- PIN 1. BASE
2. COLLECTOR
3. EMITTER

ON Semiconductor and  are registered trademarks of Semiconductor Components Industries, LLC (SCILLC). SCILLC reserves the right to make changes without further notice to any products herein. SCILLC makes no warranty, representation or guarantee regarding the suitability of its products for any particular purpose, nor does SCILLC assume any liability arising out of the application or use of any product or circuit, and specifically disclaims any and all liability, including without limitation special, consequential or incidental damages. "Typical" parameters which may be provided in SCILLC data sheets and/or specifications can and do vary in different applications and actual performance may vary over time. All operating parameters, including "Typicals" must be validated for each customer application by customer's technical experts. SCILLC does not convey any license under its patent rights nor the rights of others. SCILLC products are not designed, intended, or authorized for use as components in systems intended for surgical implant into the body, or other applications intended to support or sustain life, or for any other application in which the failure of the SCILLC product could create a situation where personal injury or death may occur. Should Buyer purchase or use SCILLC products for any such unintended or unauthorized application, Buyer shall indemnify and hold SCILLC and its officers, employees, subsidiaries, affiliates, and distributors harmless against all claims, costs, damages, and expenses, and reasonable attorney fees arising out of, directly or indirectly, any claim of personal injury or death associated with such unintended or unauthorized use, even if such claim alleges that SCILLC was negligent regarding the design or manufacture of the part. SCILLC is an Equal Opportunity/Affirmative Action Employer.

PUBLICATION ORDERING INFORMATION

Literature Fulfillment:

Literature Distribution Center for ON Semiconductor
P.O. Box 5163, Denver, Colorado 80217 USA
Phone: 303-675-2175 or 800-344-3860 Toll Free USA/Canada
Fax: 303-675-2176 or 800-344-3867 Toll Free USA/Canada
Email: ONlit@hibbertco.com

N. American Technical Support: 800-282-9855 Toll Free USA/Canada

JAPAN: ON Semiconductor, Japan Customer Focus Center
4-32-1 Nishi-Gotanda, Shinagawa-ku, Tokyo, Japan 141-0031
Phone: 81-3-5740-2700
Email: r14525@onsemi.com

ON Semiconductor Website: <http://onsemi.com>

For additional information, please contact your local Sales Representative.