

Power SMD LED PLCC-2

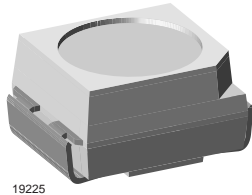

19225

FEATURES

- Utilizing (AS) AlInGaP technology
- Available in 8 mm tape
- Luminous intensity, color and forward voltage categorized per packing unit
- Luminous intensity ratio per packing unit
 $I_{Vmax}/I_{Vmin} \leq 1.6$
- Thermal resistance $R = 400 \text{ K/W}$
- ESD-withstand voltage: up to 2 kV according to JESD22-A114-B
- Suitable for all soldering methods according to CECC
- Lead (Pb)-free device
- Preconditioning: acc. to JEDEC level 2a



DESCRIPTION

The TLM.33.. series is an advanced modification of the Vishay TLM.31.. series. It is designed to incorporate larger chips, therefore, capable of withstanding a 50 mA drive current.

The package of the TLM.33.. is the PLCC-2.

It consists of a lead frame which is embedded in a white thermoplast. The reflector inside this package is filled up with clear epoxy.

APPLICATIONS

- Traffic signals and signs
- Interior and exterior lighting
- Dashboard illumination
- Indicator and backlighting purposes for audio, video, LCDs switches, symbols, illuminated advertising etc

PRODUCT GROUP AND PACKAGE DATA

- Product group: LED
- Package: SMD PLCC-2
- Product series: power
- Angle of half intensity: $\pm 60^\circ$

PARTS TABLE		
PART	COLOR, LUMINOUS INTENSITY	TECHNOLOGY
TLMK3300-GS08	Red, $I_V > 200 \text{ mcd}$	AllnGaP on GaAs
TLMK3300-GS18	Red, $I_V > 200 \text{ mcd}$	AllnGaP on GaAs
TLMK3301-GS08	Red, $I_V = (250 \text{ to } 800) \text{ mcd}$	AllnGaP on GaAs
TLMK3301-GS18	Red, $I_V = (250 \text{ to } 800) \text{ mcd}$	AllnGaP on GaAs
TLMK3302-GS08	Red, $I_V = (400 \text{ to } 800) \text{ mcd}$	AllnGaP on GaAs
TLMK3302-GS18	Red, $I_V = (400 \text{ to } 800) \text{ mcd}$	AllnGaP on GaAs
TLMK3303-GS08	Red, $I_V = (400 \text{ to } 1250) \text{ mcd}$	AllnGaP on GaAs
TLMS3300-GS08	Red, $I_V > 160 \text{ mcd}$	AllnGaP on GaAs
TLMS3301-GS08	Red, $I_V = (160 \text{ to } 400) \text{ mcd}$	AllnGaP on GaAs
TLMS3302-GS08	Red, $I_V = (250 \text{ to } 800) \text{ mcd}$	AllnGaP on GaAs

PARTS TABLE		
PART	COLOR, LUMINOUS INTENSITY	TECHNOLOGY
TLMO3300-GS08	Soft orange, $I_V > 200$ mcd	AllnGaP on GaAs
TLMO3301-GS08	Soft orange, $I_V = (250 \text{ to } 640)$ mcd	AllnGaP on GaAs
TLMO3302-GS08	Soft orange, $I_V = (320 \text{ to } 800)$ mcd	AllnGaP on GaAs
TLMO3303-GS08	Soft orange, $I_V = (400 \text{ to } 1250)$ mcd	AllnGaP on GaAs
TLMY3300-GS08	Yellow, $I_V > 200$ mcd	AllnGaP on GaAs
TLMY3301-GS08	Yellow, $I_V = (250 \text{ to } 640)$ mcd	AllnGaP on GaAs
TLMY3302-GS08	Yellow, $I_V = (320 \text{ to } 800)$ mcd	AllnGaP on GaAs
TLMY3303-GS08	Yellow, $I_V = (400 \text{ to } 1250)$ mcd	AllnGaP on GaAs

ABSOLUTE MAXIMUM RATINGS ¹⁾ TLMY33.., TLMO33.., TLMK33.., TLMS33..				
PARAMETER	TEST CONDITION	SYMBOL	VALUE	UNIT
Reverse voltage ²⁾		V_R	5	V
DC Forward current	$T_{amb} \leq 73$ °C (400 K/W)	I_F	50	mA
Power dissipation	$T_{amb} \leq 73$ °C (400 K/W)	P_V	130	mW
Junction temperature		T_j	125	°C
Operating temperature range		T_{amb}	- 40 to + 100	°C
Storage temperature range		T_{stg}	- 40 to + 100	°C
Soldering temperature	$t \leq 5$ s	T_{sd}	260	°C
Thermal resistance junction/ambient	mounted on PC board (pad size > 16 mm ²)	R_{thJA}	400	K/W

Note:

¹⁾ $T_{amb} = 25$ °C, unless otherwise specified

²⁾ Driving LED in reverse direction is suitable for short term application

OPTICAL AND ELECTRICAL CHARACTERISTICS ¹⁾ TLMK33.., RED							
PARAMETER	TEST CONDITION	PART	SYMBOL	MIN	TYP.	MAX	UNIT
Luminous intensity	$I_F = 50$ mA	TLMK3300	I_V	200	500		mcd
		TLMK3301	I_V	250		800	mcd
		TLMK3302	I_V	400		800	mcd
		TLMK3303	I_V	400		1250	mcd
Luminous flux/Luminous intensity			ϕ_V/I_V		3		mlm/mcd
Dominant wavelength	$I_F = 50$ mA		λ_d	611	617	622	nm
Peak wavelength	$I_F = 50$ mA		λ_p		624		nm
Spectral bandwidth at 50 % $I_{rel \text{ max}}$	$I_F = 50$ mA		$\Delta\lambda$		18		nm
Angle of half intensity	$I_F = 50$ mA		ϕ		± 60		deg
Forward voltage	$I_F = 50$ mA		V_F	1.85	2.1	2.55	V
Reverse current	$V_R = 5$ V		V_R		0.01	10	μ A

Note:

¹⁾ $T_{amb} = 25$ °C, unless otherwise specified



OPTICAL AND ELECTRICAL CHARACTERISTICS¹⁾ TLMS33.., RED							
PARAMETER	TEST CONDITION	PART	SYMBOL	MIN	TYP.	MAX	UNIT
Luminous intensity	$I_F = 50 \text{ mA}$	TLMS3300	I_V	160	300		mcd
		TLMS3301	I_V	160		400	mcd
		TLMS3302	I_V	250		800	mcd
Luminous flux/Luminous intensity			ϕ_V/I_V		3		mlm/mcd
Dominant wavelength	$I_F = 50 \text{ mA}$		λ_d	626	630	638	nm
Peak wavelength	$I_F = 50 \text{ mA}$		λ_p		641		nm
Spectral bandwidth at 50 % $I_{rel \text{ max}}$	$I_F = 50 \text{ mA}$		$\Delta\lambda$		17		nm
Angle of half intensity	$I_F = 50 \text{ mA}$		φ		± 60		deg
Forward voltage	$I_F = 50 \text{ mA}$		V_F	1.85	2.1	2.55	V
Reverse current	$V_R = 5 \text{ V}$		V_R		0.01	10	μA

Note:

¹⁾ $T_{amb} = 25 \text{ }^\circ\text{C}$, unless otherwise specified

OPTICAL AND ELECTRICAL CHARACTERISTICS¹⁾ TLMO33.., SOFT ORANGE							
PARAMETER	TEST CONDITION	PART	SYMBOL	MIN	TYP.	MAX	UNIT
Luminous intensity	$I_F = 50 \text{ mA}$	TLMO3300	I_V	200	500		mcd
		TLMO3301	I_V	250		640	mcd
		TLMO3302	I_V	320		800	mcd
		TLMO3303	I_V	400		1250	mcd
Luminous flux/Luminous intensity			ϕ_V/I_V		3		mlm/mcd
Dominant wavelength	$I_F = 50 \text{ mA}$		λ_d	600	605	611	nm
Peak wavelength	$I_F = 50 \text{ mA}$		λ_p		611		nm
Spectral bandwidth at 50 % $I_{rel \text{ max}}$	$I_F = 50 \text{ mA}$		$\Delta\lambda$		17		nm
Angle of half intensity	$I_F = 50 \text{ mA}$		φ		± 60		deg
Forward voltage	$I_F = 50 \text{ mA}$		V_F	1.85	2.1	2.55	V
Reverse current	$V_R = 5 \text{ V}$		V_R		0.01	10	μA

Note:

¹⁾ $T_{amb} = 25 \text{ }^\circ\text{C}$, unless otherwise specified



OPTICAL AND ELECTRICAL CHARACTERISTICS ¹⁾ TLMY33..., YELLOW							
PARAMETER	TEST CONDITION	PART	SYMBOL	MIN	TYP.	MAX	UNIT
Luminous intensity	$I_F = 50 \text{ mA}$	TLMY3300	I_V	200	450		mcd
		TLMY3301	I_V	250		640	mcd
		TLMY3302	I_V	320		800	mcd
		TLMY3303	I_V	400		1250	mcd
Luminous flux/Luminous intensity			ϕ_V/I_V		3		mlm/mcd
Dominant wavelength	$I_F = 50 \text{ mA}$		λ_d	583	588	594	nm
Peak wavelength	$I_F = 50 \text{ mA}$		λ_p		590		nm
Spectral bandwidth at 50 % $I_{rel \text{ max}}$	$I_F = 50 \text{ mA}$		$\Delta\lambda$		18		nm
Angle of half intensity	$I_F = 50 \text{ mA}$		φ		± 60		deg
Forward voltage	$I_F = 50 \text{ mA}$		V_F	1.85	2.1	2.55	V
Reverse current	$V_R = 5 \text{ V}$		V_R		0.01	10	μA

Note:

¹⁾ $T_{amb} = 25 \text{ }^\circ\text{C}$, unless otherwise specified

FORWARD VOLTAGE CLASSIFICATION			
GROUP	FORWARD VOLTAGE (V)		
	MIN		MAX
1	1.85		2.25
2	2.15		2.55

COLOR CLASSIFICATION						
GROUP	DOMINANT WAVELENGTH (NM)					
	RED		SOFT ORANGE		YELLOW	
	min	max	min	max	min	max
1	611	618	598	601	581	584
2	614	622	600	603	583	586
3			602	605	585	588
4			604	607	587	590
5			606	609	589	592
6			608	611	591	594

LUMINOUS INTENSITY CLASSIFICATION			
GROUP	LUMINOUS INTENSITY (MCD)		
	MIN		MAX
Xa	160		250
Xb	200		320
Ya	250		400
Yb	320		500
Za	400		630
Zb	500		800
0a	630		1000
0b	800		1250

GROUP NAME ON LABEL			
Luminous Intensity Group	Halfgroup	Wavelength	Forward Voltage
Z	b	2	1

One packing unit/tape contains only one classification group of luminous intensity, color and forward voltage.
Only one single classification groups is not available.
The given groups are not order codes, customer specific group combinations require marketing agreement.
No color subgrouping for super red.

TYPICAL CHARACTERISTICS

$T_{amb} = 25\text{ }^{\circ}\text{C}$, unless otherwise specified

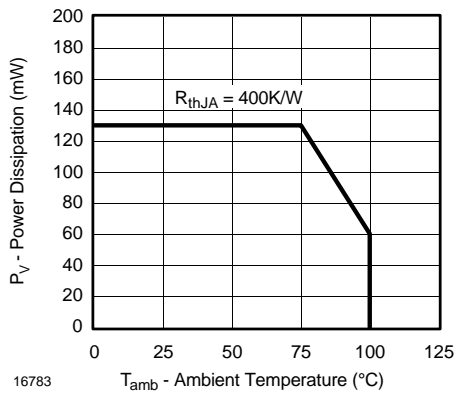

Figure 1. Power Dissipation vs. Ambient Temperature

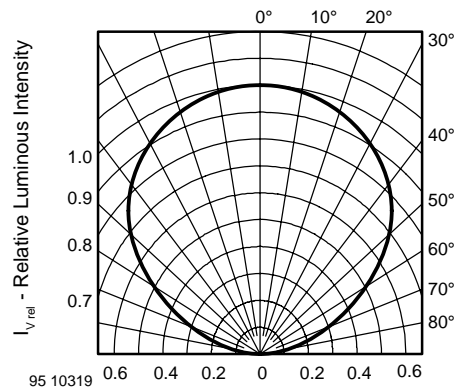

Figure 3. Rel. Luminous Intensity vs. Angular Displacement

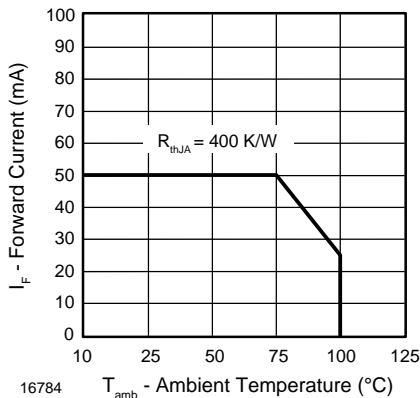

Figure 2. Forward Current vs. Ambient Temperature

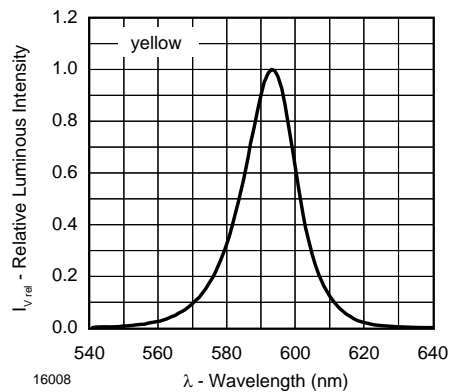

Figure 4. Relative Intensity vs. Wavelength

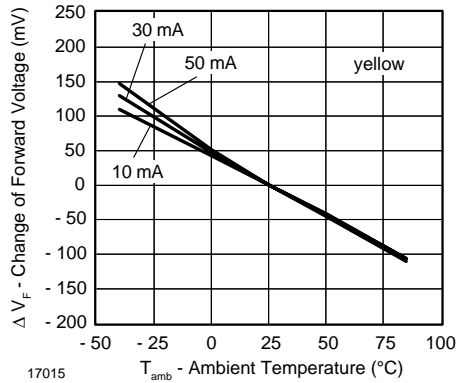

Figure 5. Change of Forward Voltage vs. Ambient Temperature

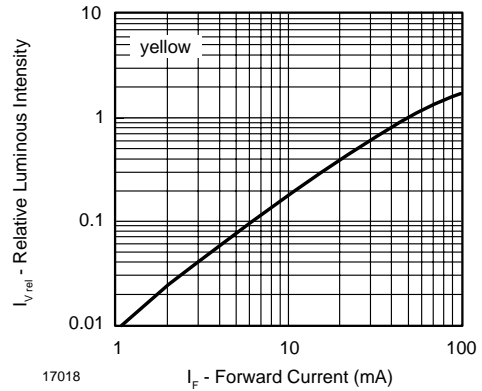

Figure 8. Relative Luminous Intensity vs. Forward Current

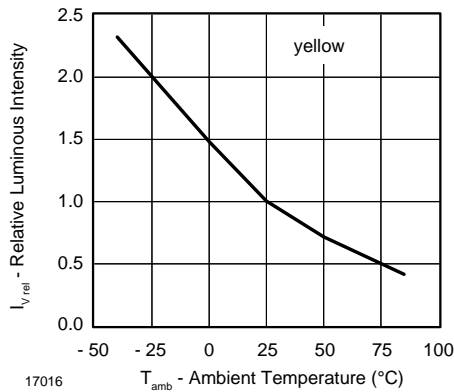

Figure 6. Relative Luminous Intensity vs. Amb. Temperature

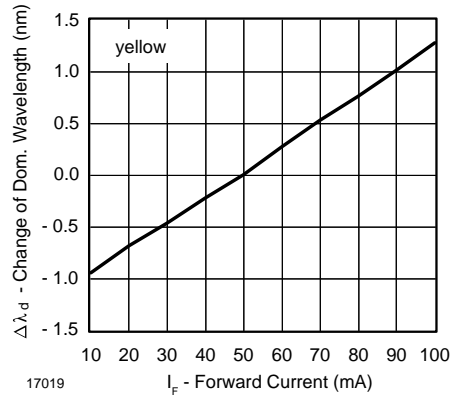

Figure 9. Change of Dominant Wavelength vs. Forward Current

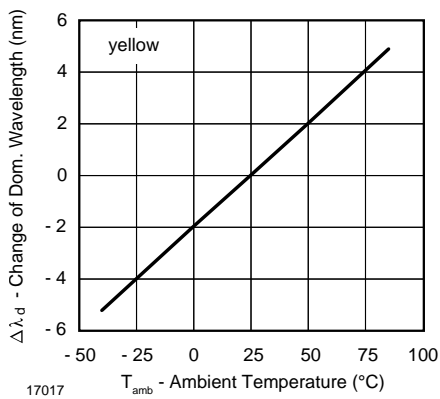

Figure 7. Change of Dominant Wavelength vs. Ambient Temperature

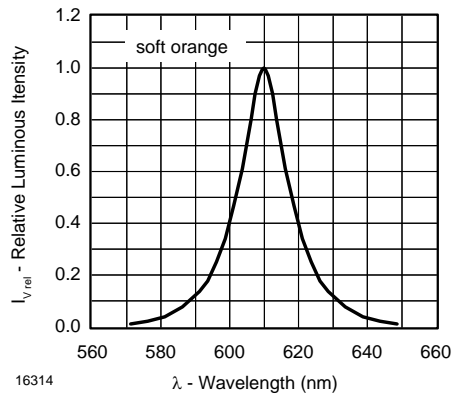

Figure 10. Relative Intensity vs. Wavelength

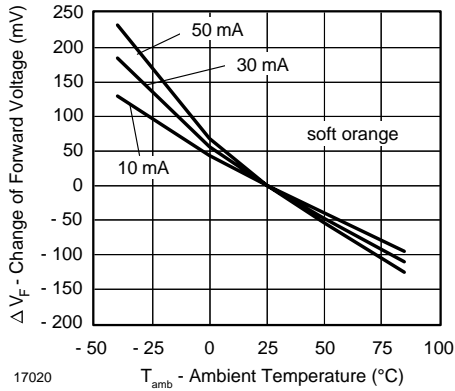

Figure 11. Change of Forward Voltage vs. Ambient Temperature

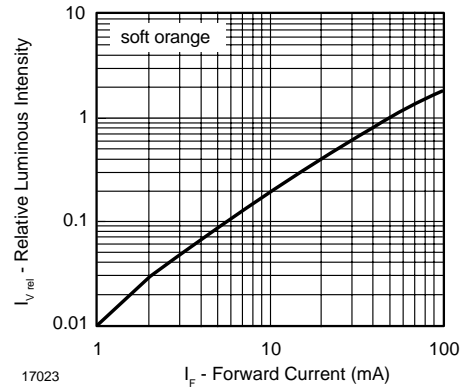

Figure 14. Relative Luminous Intensity vs. Forward Current

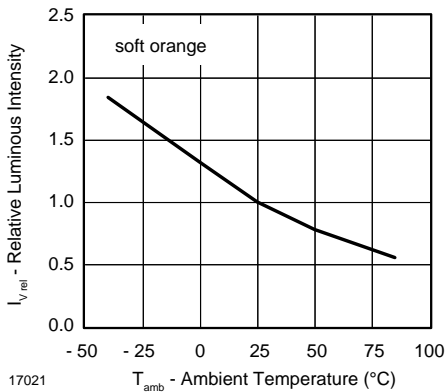

Figure 12. Relative Luminous Intensity vs. Amb. Temperature

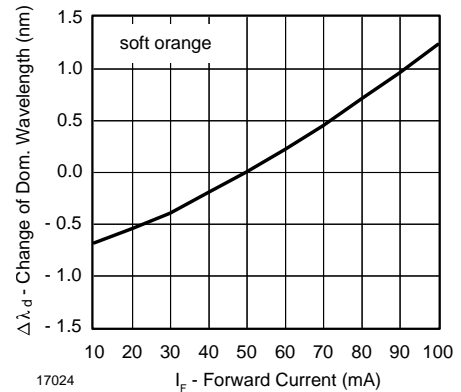

Figure 15. Change of Dominant Wavelength vs. Forward Current

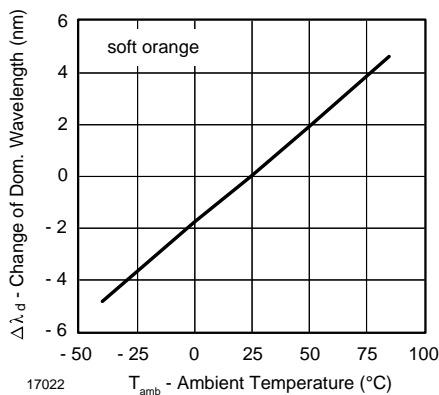

Figure 13. Change of Dominant Wavelength vs. Ambient Temperature

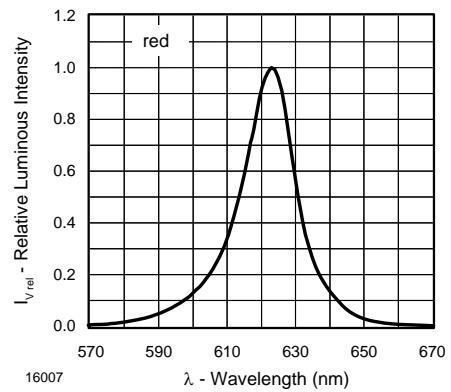

Figure 16. Relative Intensity vs. Wavelength

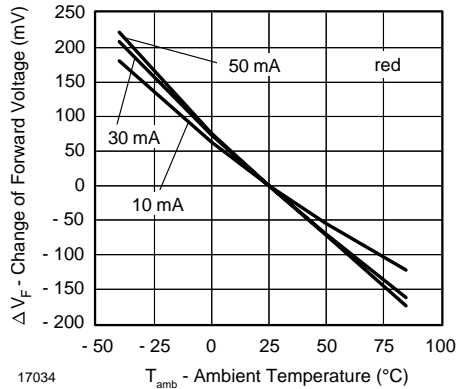

Figure 17. Change of Forward Voltage vs. Ambient Temperature

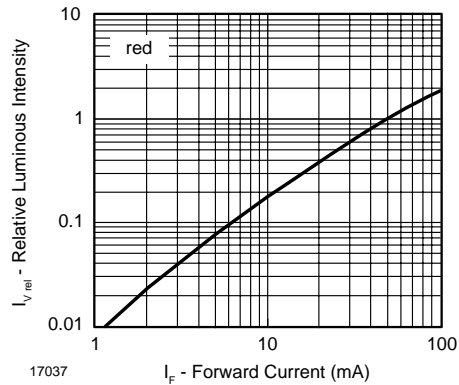

Figure 20. Relative Luminous Intensity vs. Forward Current

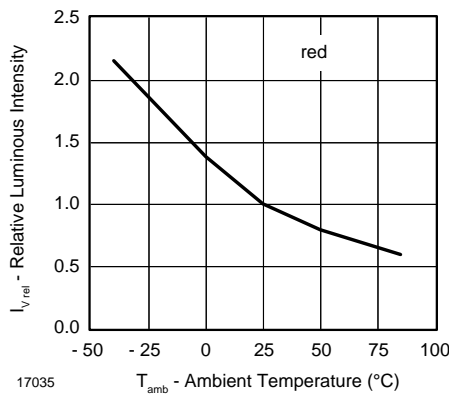

Figure 18. Relative Luminous Intensity vs. Amb. Temperature

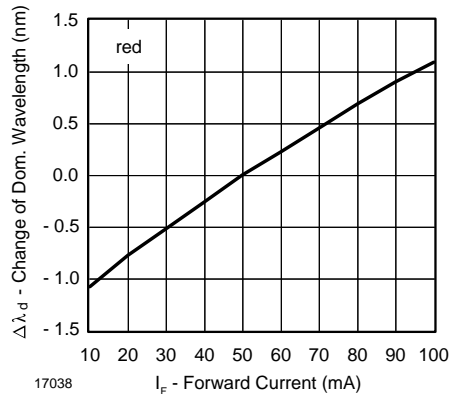

Figure 21. Change of Dominant Wavelength vs. Forward Current

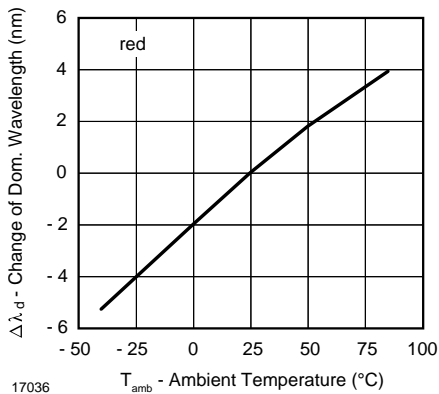

Figure 19. Change of Dominant Wavelength vs. Ambient Temperature

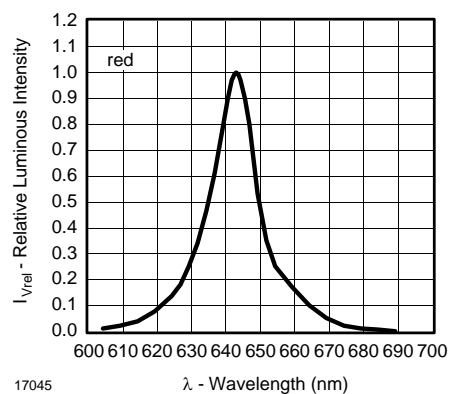

Figure 22. Relative Intensity vs. Wavelength

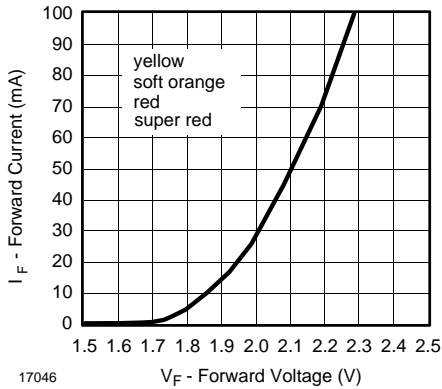

Figure 23. Forward Current vs. Forward Voltage

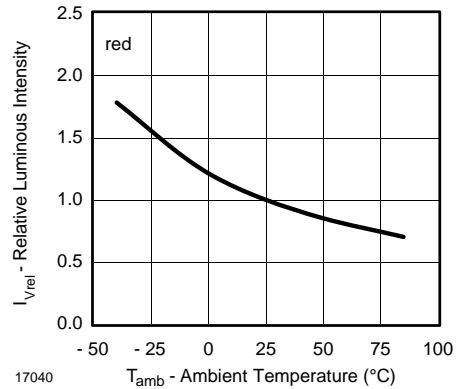

Figure 26. Relative Luminous Intensity vs. Ambient Temperature

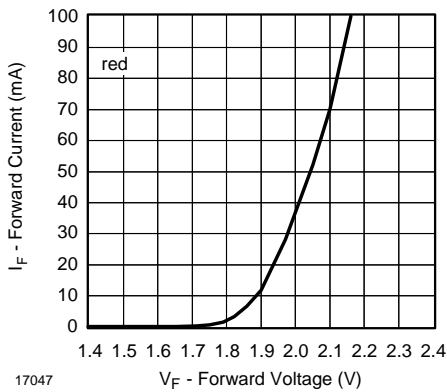

Figure 24. Forward Current vs. Forward Voltage

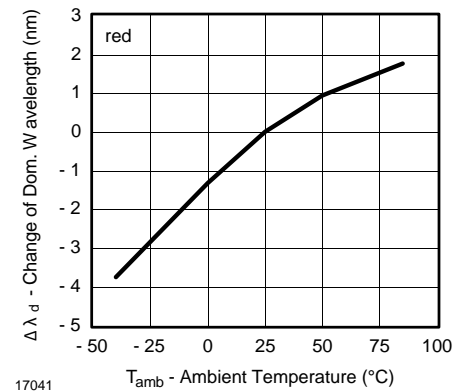

Figure 27. Change of Dominant Wavelength vs. Ambient Temperature

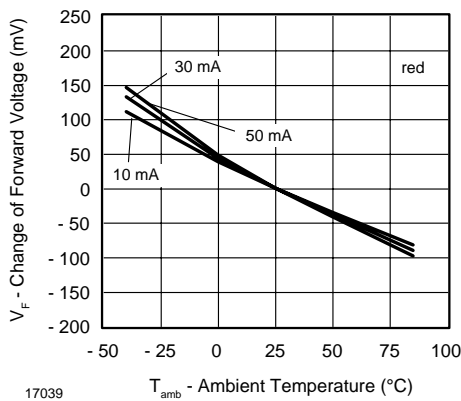

Figure 25. Change of Forward Voltage vs. Ambient Temperature

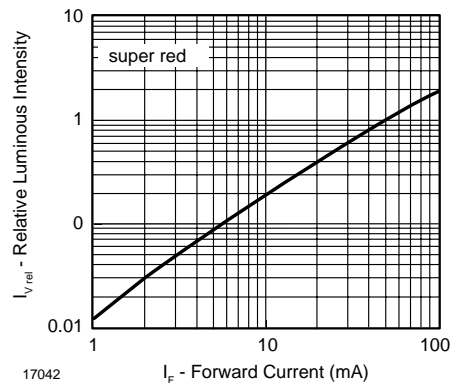

Figure 28. Relative Luminous Intensity vs. Forward Current

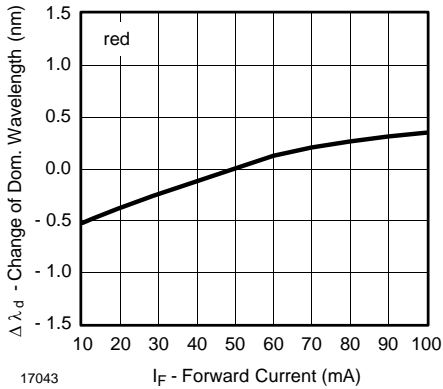

Figure 29. Change of Dominant Wavelength vs. Forward Current

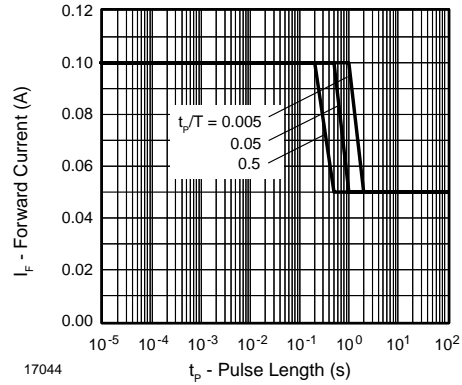
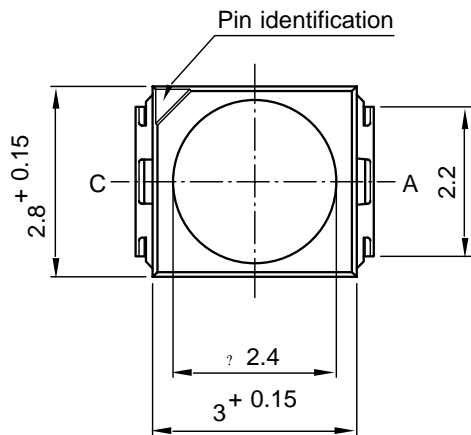
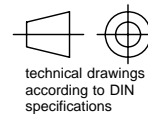
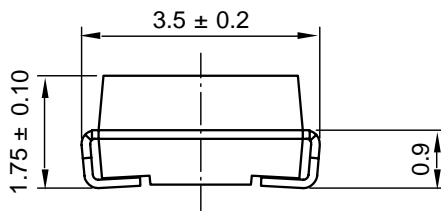
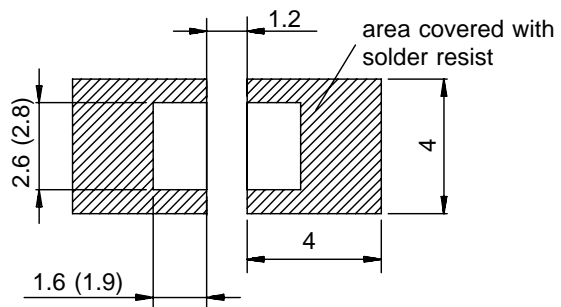

Figure 30. Forward Current vs. Pulse Length

PACKAGE DIMENSIONS in millimeters



Mounting Pad Layout



Drawing-No.: 6.541-5025.01-4
 Issue: 8; 22.11.05
 95 11314-1



OZONE DEPLETING SUBSTANCES POLICY STATEMENT

It is the policy of Vishay Semiconductor GmbH to

1. Meet all present and future national and international statutory requirements.
2. Regularly and continuously improve the performance of our products, processes, distribution and operating systems with respect to their impact on the health and safety of our employees and the public, as well as their impact on the environment.

It is particular concern to control or eliminate releases of those substances into the atmosphere which are known as ozone depleting substances (ODSs).

The Montreal Protocol (1987) and its London Amendments (1990) intend to severely restrict the use of ODSs and forbid their use within the next ten years. Various national and international initiatives are pressing for an earlier ban on these substances.

Vishay Semiconductor GmbH has been able to use its policy of continuous improvements to eliminate the use of ODSs listed in the following documents.

1. Annex A, B and list of transitional substances of the Montreal Protocol and the London Amendments respectively
2. Class I and II ozone depleting substances in the Clean Air Act Amendments of 1990 by the Environmental Protection Agency (EPA) in the USA
3. Council Decision 88/540/EEC and 91/690/EEC Annex A, B and C (transitional substances) respectively.

Vishay Semiconductor GmbH can certify that our semiconductors are not manufactured with ozone depleting substances and do not contain such substances.

We reserve the right to make changes to improve technical design
and may do so without further notice.

Parameters can vary in different applications. All operating parameters must be validated for each customer application by the customer. Should the buyer use Vishay Semiconductors products for any unintended or unauthorized application, the buyer shall indemnify Vishay Semiconductors against all claims, costs, damages, and expenses, arising out of, directly or indirectly, any claim of personal damage, injury or death associated with such unintended or unauthorized use.

Vishay Semiconductor GmbH, P.O.B. 3535, D-74025 Heilbronn, Germany



Disclaimer

All product specifications and data are subject to change without notice.

Vishay Intertechnology, Inc., its affiliates, agents, and employees, and all persons acting on its or their behalf (collectively, "Vishay"), disclaim any and all liability for any errors, inaccuracies or incompleteness contained herein or in any other disclosure relating to any product.

Vishay disclaims any and all liability arising out of the use or application of any product described herein or of any information provided herein to the maximum extent permitted by law. The product specifications do not expand or otherwise modify Vishay's terms and conditions of purchase, including but not limited to the warranty expressed therein, which apply to these products.

No license, express or implied, by estoppel or otherwise, to any intellectual property rights is granted by this document or by any conduct of Vishay.

The products shown herein are not designed for use in medical, life-saving, or life-sustaining applications unless otherwise expressly indicated. Customers using or selling Vishay products not expressly indicated for use in such applications do so entirely at their own risk and agree to fully indemnify Vishay for any damages arising or resulting from such use or sale. Please contact authorized Vishay personnel to obtain written terms and conditions regarding products designed for such applications.

Product names and markings noted herein may be trademarks of their respective owners.