

TLV1393, TLV1393Y, TLV2393, TLV2393Y DUAL DIFFERENTIAL COMPARATORS

SLCS121A – AUGUST 1993 – REVISED APRIL 1994

- **Low-Voltage and Single-Supply Operation**
 $V_{CC} = 2\text{ V to }7\text{ V}$
- **Common-Mode Voltage Range Includes Ground**
- **Fast Response Time**
450 ns Typ (TLV2393)
- **Low Supply Current**
0.16 mA Typ (TLV1393)
- **Fully Specified at 3-V and 5-V Supply Voltages**

D, P, OR PW PACKAGE
(TOP VIEW)

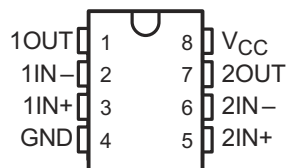

description

The TLV1393 and the TLV2393 are dual differential comparators built using a new Texas Instruments low-voltage, high-speed bipolar process. These devices have been specifically developed for low-voltage, single-supply applications. Their enhanced performance makes them excellent replacements for the LM393 in today's improved 3-V and 5-V system designs.

The TLV1393, with its typical supply current of only 0.16 mA, is ideal for low-power systems. Response time has also been improved to 0.7 μs . For higher-speed applications, the TLV2393 features excellent ac performance with a response time of just 0.45 μs , three times that of the LM393.

Package availability for these devices includes the TSSOP (thin-shrink small-outline package). With a maximum thickness of 1.1 mm and a package area that is 25% smaller than the standard surface-mount package, the TSSOP is ideal for high-density circuits, particularly in hand-held and portable equipment.

AVAILABLE OPTIONS

T _A	PACKAGED DEVICES					CHIP FORM (Y)
	SUPPLY CURRENT (TYP)	RESPONSE TIME (TYP)	SMALL OUTLINE (D)	PLASTIC DIP (P)	TSSOP (PW) [†]	
-40°C to 105°C	0.16 mA	0.7 μs	TLV1393ID	TLV1393IP	TLV1393IPWLE	TLV1393Y
	1.1 mA	0.45 μs	TLV2393ID	TLV2393IP	TLV2393IPWLE	TLV2393Y

[†] The PW packages are only available left-ended taped and reeled (e.g., TLV1393IPWLE).

symbol (each comparator)

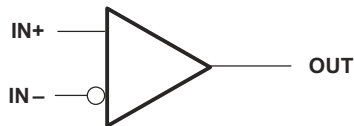

PRODUCTION DATA information is current as of publication date. Products conform to specifications per the terms of Texas Instruments standard warranty. Production processing does not necessarily include testing of all parameters.

 **TEXAS
INSTRUMENTS**

POST OFFICE BOX 655303 • DALLAS, TEXAS 75265

Copyright © 1994, Texas Instruments Incorporated

TLV1393, TLV1393Y, TLV2393, TLV2393Y DUAL DIFFERENTIAL COMPARATORS

SLCS121A – AUGUST 1993 – REVISED APRIL 1994

TLV1393, TLV1393Y equivalent schematic (each comparator)

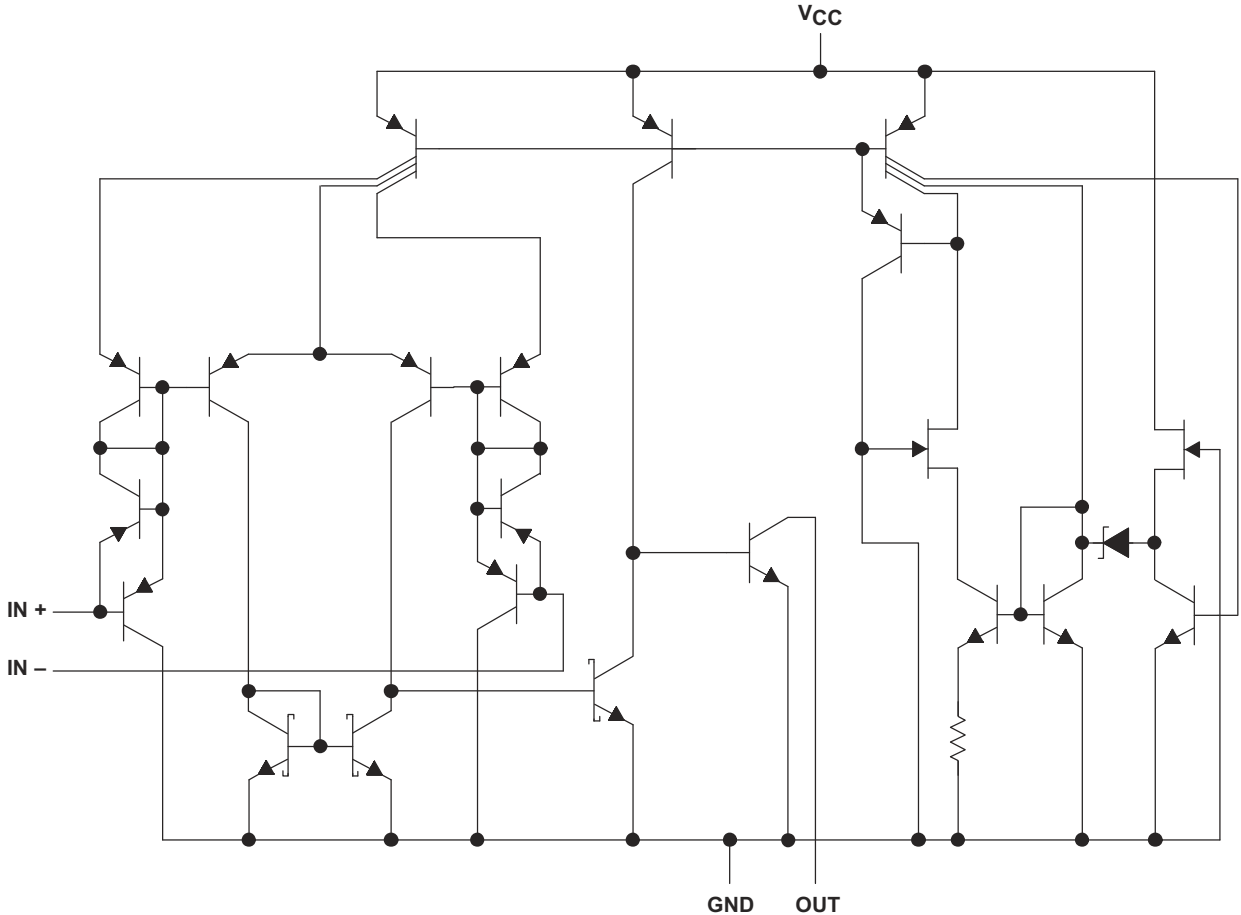

COMPONENT COUNT	
Transistors	44
Resistors	1
Diodes	7
Epi-FET	2

TLV2393, TLV2393Y equivalent schematic (each comparator)

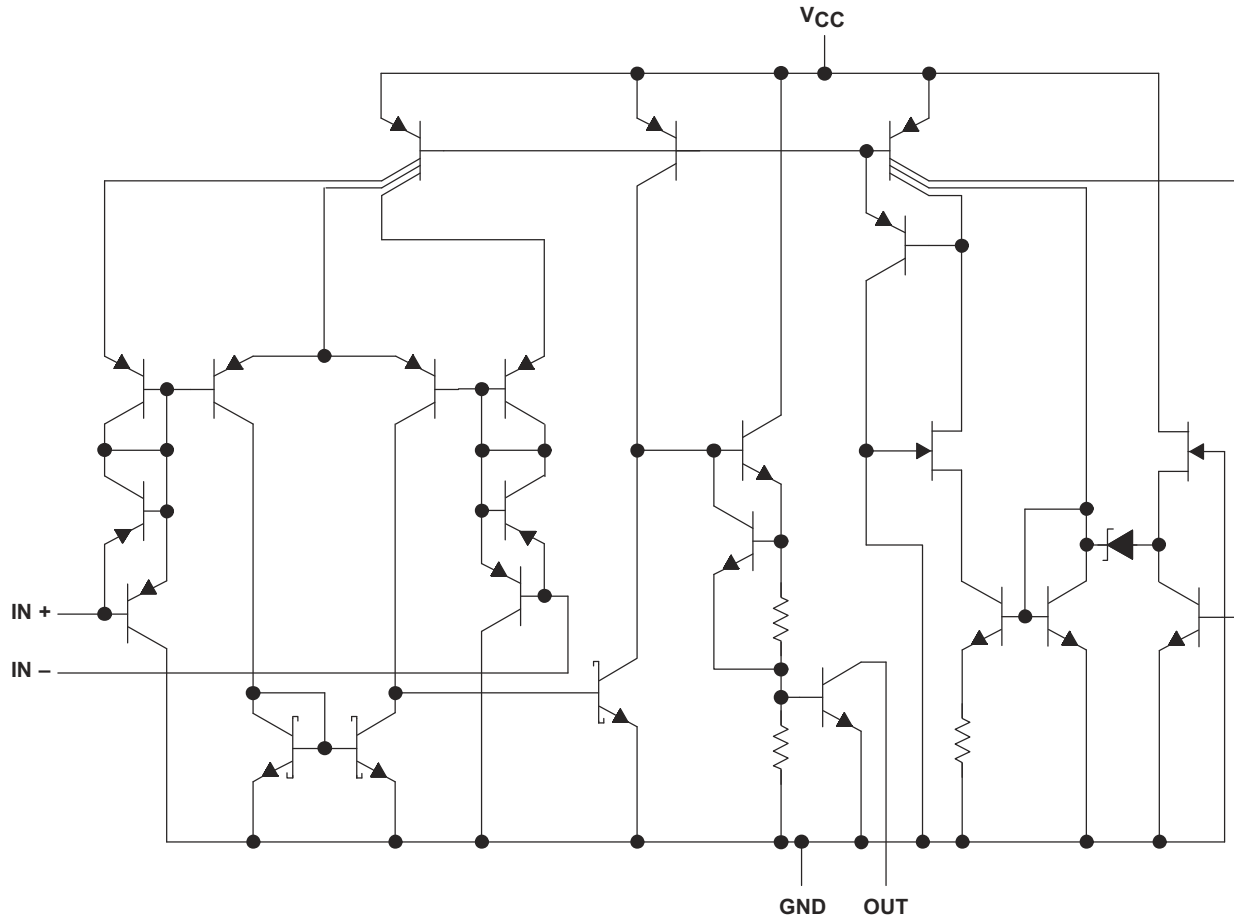

COMPONENT COUNT	
Transistors	44
Resistors	1
Diodes	7
Epi-FET	2

TLV1393, TLV1393Y, TLV2393, TLV2393Y DUAL DIFFERENTIAL COMPARATORS

SLCS121A – AUGUST 1993 – REVISED APRIL 1994

TLV1393Y chip information

This chip, when properly assembled, displays characteristics similar to the TLV1393. Thermal compression or ultrasonic bonding may be used on the doped-aluminum bonding pads. Chips may be mounted with conductive epoxy or a gold-silicon preform.

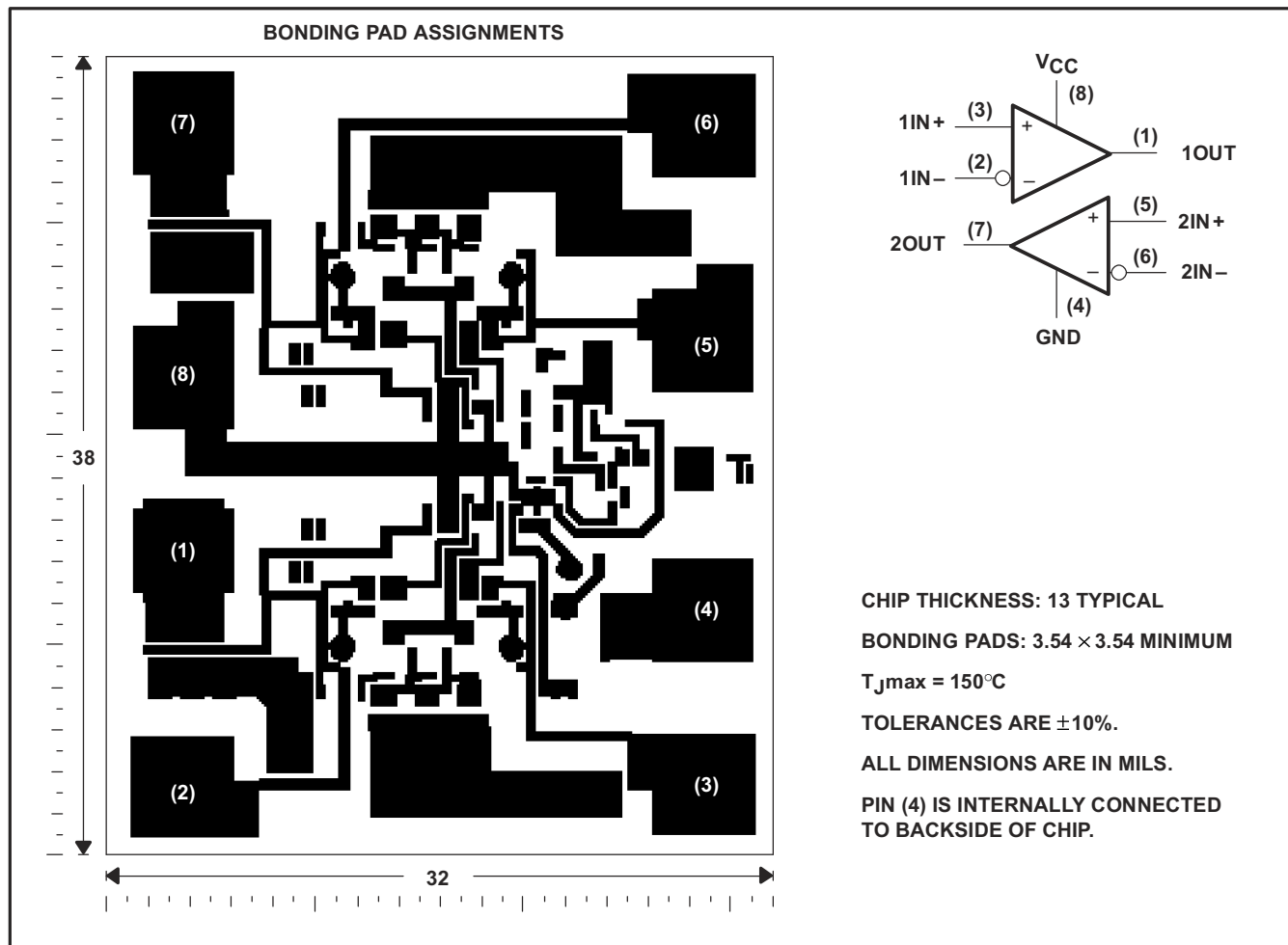

TLV1393, TLV1393Y, TLV2393, TLV2393Y DUAL DIFFERENTIAL COMPARATORS

SLCS121A – AUGUST 1993 – REVISED APRIL 1994

TLV2393Y chip information

This chip, when properly assembled, displays characteristics similar to the TLV2393. Thermal compression or ultrasonic bonding may be used on the doped-aluminum bonding pads. Chips may be mounted with conductive epoxy or a gold-silicon preform.

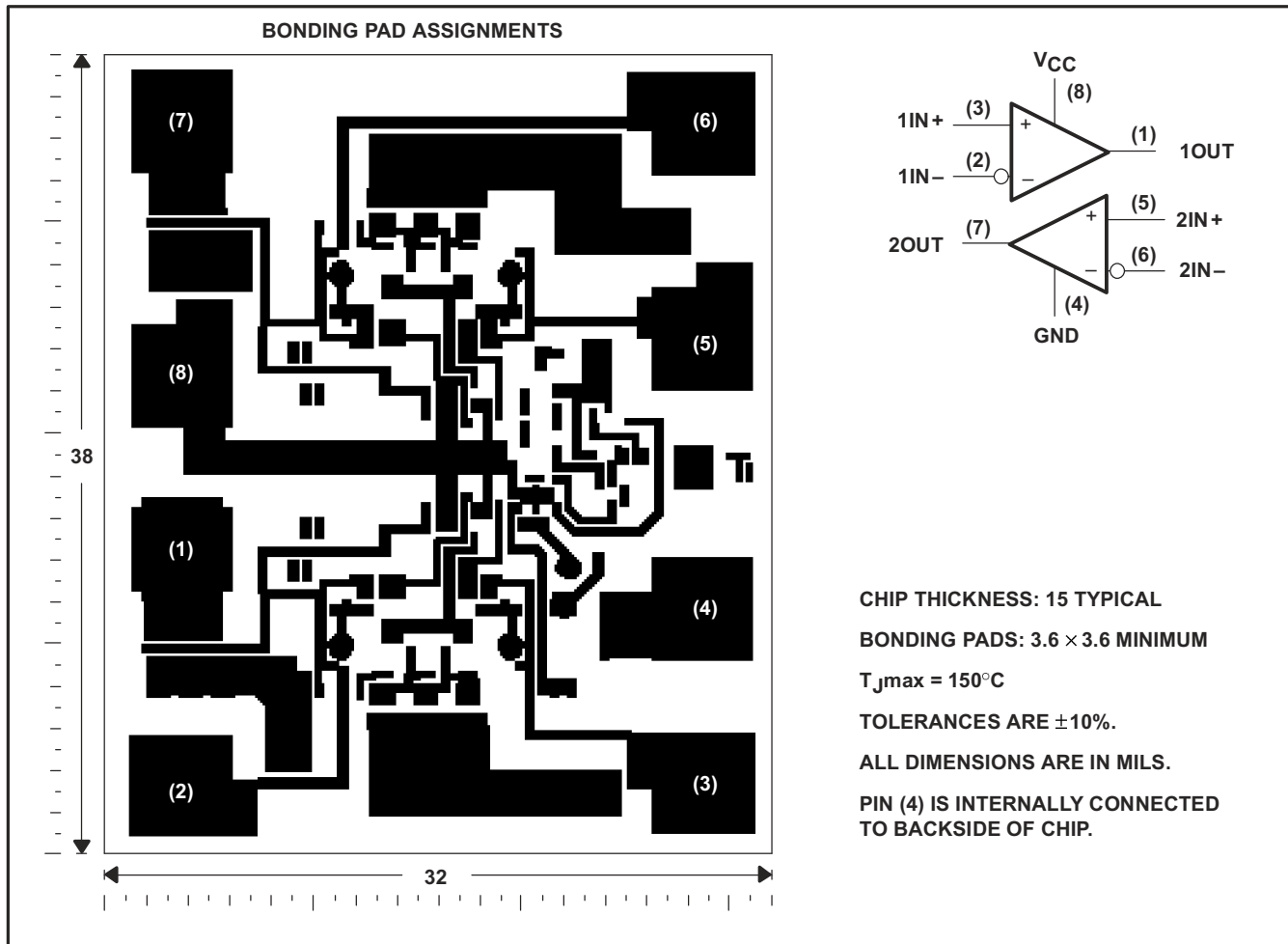

TLV1393, TLV1393Y, TLV2393, TLV2393Y DUAL DIFFERENTIAL COMPARATORS

SLCS121A – AUGUST 1993 – REVISED APRIL 1994

absolute maximum ratings over operating free-air temperature range (unless otherwise noted)†

Supply voltage, V_{CC} (see Note 1)	7 V
Differential input voltage, V_{ID} (see Note 2)	7 V
Input voltage, V_I (any input)	7 V
Output voltage, V_O	7 V
Output current, I_O (each output)	20 mA
Duration of short-circuit current to GND (see Note 3)	unlimited
Continuous total dissipation	See Dissipation Rating Table
Operating free-air temperature range, T_A	-40°C to 105°C
Storage temperature range	-65°C to 150°C
Lead temperature 1,6 mm (1/16 inch) from case for 10 seconds	260°C

† Stresses beyond those listed under "absolute maximum ratings" may cause permanent damage to the device. These are stress ratings only, and functional operation of the device at these or any other conditions beyond those indicated under "recommended operating conditions" is not implied. Exposure to absolute-maximum-rated conditions for extended periods may affect device reliability.

- NOTES: 1. All voltage values, except differential voltages, are with respect to the network GND.
 2. Differential voltages are at the noninverting input with respect to the inverting input.
 3. Short circuits from the outputs to V_{CC} can cause excessive heating and eventual destruction of the chip.

DISSIPATION RATING TABLE

PACKAGE	$T_A \leq 25^\circ\text{C}$	DERATING FACTOR	$T_A = 70^\circ\text{C}$	$T_A = 85^\circ\text{C}$
	POWER RATING	ABOVE $T_A = 25^\circ\text{C}$	POWER RATING	POWER RATING
D	725 mW	5.8 mW/°C	464 mW	377 mW
P	1000 mW	8.0 mW/°C	640 mW	520 mW
PW	525 mW	4.2 mW/°C	336 mW	273 mW

recommended operating conditions

	MIN	MAX	UNIT
Supply voltage, V_{CC}	2	7	V
Operating free-air temperature, T_A	-40	105	°C



TLV1393, TLV1393Y, TLV2393, TLV2393Y DUAL DIFFERENTIAL COMPARATORS

SLCS121A – AUGUST 1993 – REVISED APRIL 1994

electrical characteristics, $V_{CC} = 3\text{ V}$

PARAMETER	TEST CONDITIONS	T_A^\dagger	TLV1393			UNIT
			MIN	TYP	MAX	
V_{IO} Input offset voltage	$V_O = 1.4\text{ V}$, $V_{IC} = V_{ICRmin}$	25°C		1.5	5	mV
		Full range		120	9	
V_{ICR} Common-mode input voltage range		25°C	0 to $V_{CC} - 1.5$	0 to $V_{CC} - 1.2$		V
		Full range	0 to $V_{CC} - 2$			
V_{OL} Low-level output voltage	$V_{ID} = -1\text{ V}$, $I_{OL} = 500\text{ }\mu\text{A}$	Full range		120	300	mV
I_{IO} Input offset current	$V_O = 1.4\text{ V}$	25°C		5	50	nA
		Full range			150	
I_{IB} Input bias current	$V_O = 1.4\text{ V}$	25°C		-40	-250	nA
		Full range			-400	
I_{OH} High-level output current	$V_{ID} = 1\text{ V}$, $V_{OH} = 3\text{ V}$	25°C		0.1		nA
	$V_{ID} = 1\text{ V}$, $V_{OH} = 5\text{ V}$	Full range			100	
I_{OL} Low-level output current	$V_{ID} = -1\text{ V}$, $V_{OL} = 1.5\text{ V}$	25°C	500			μA
I_{CCH} High-level supply current	$V_O = V_{OH}$	25°C		160	250	μA
		Full range			300	
I_{CCL} Low-level supply current	$V_O = V_{OL}$	25°C		160	250	μA
		Full range			300	

† Full range is -40°C to 105°C .

switching characteristics, $V_{CC} = 3\text{ V}$, $C_L = 15\text{ pF}$, $T_A = 25^\circ\text{C}$

PARAMETER	TEST CONDITIONS	TLV1393			UNIT
		MIN	TYP	MAX	
Response time	100-mV input step with 5-mV overdrive, R_L connected to 5 V through 5.1 k Ω		0.7		μs



TLV1393, TLV1393Y, TLV2393, TLV2393Y DUAL DIFFERENTIAL COMPARATORS

SLCS121A – AUGUST 1993 – REVISED APRIL 1994

electrical characteristics, $V_{CC} = 5\text{ V}$

PARAMETER	TEST CONDITIONS	T_A †	TLV1393			UNIT
			MIN	TYP	MAX	
V_{IO} Input offset voltage	$V_O = 1.4\text{ V}$, $V_{IC} = V_{ICRmin}$	25°C		1.5	5	mV
		Full range			9	
V_{ICR} Common-mode input voltage range		25°C	0 to $V_{CC} - 1.5$	0 to $V_{CC} - 1.2$		V
		Full range	0 to $V_{CC} - 2$			
V_{OL} Low-level output voltage	$V_{ID} = -1\text{ V}$, $I_{OL} = 500\text{ }\mu\text{A}$	Full range		120	300	mV
I_{IO} Input offset current	$V_O = 1.4\text{ V}$	25°C		5	50	nA
		Full range			150	
I_{IB} Input bias current	$V_O = 1.4\text{ V}$	25°C		-40	-250	nA
		Full range			-400	
I_{OH} High-level output current	$V_{ID} = 1\text{ V}$, $V_{OH} = 3\text{ V}$	25°C		0.1		nA
	$V_{ID} = 1\text{ V}$, $V_{OH} = 5\text{ V}$	Full range			100	
I_{OL} Low-level output current	$V_{ID} = -1\text{ V}$, $V_{OL} = 1.5\text{ V}$	25°C	600			μA
I_{CCH} High-level supply current	$V_O = V_{OH}$	25°C		200	300	μA
		Full range			350	
I_{CCL} Low-level supply current	$V_O = V_{OL}$	25°C		200	300	μA
		Full range			350	

† Full range is -40°C to 105°C .

switching characteristics, $V_{CC} = 5\text{ V}$, $C_L = 15\text{ pF}$, $T_A = 25^\circ\text{C}$

PARAMETER	TEST CONDITIONS	TLV1393			UNIT
		MIN	TYP	MAX	
Response time	100-mV input step with 5-mV overdrive, R_L connected to 5 V through 5.1 k Ω		0.65		μs
	TTL-level input step, R_L connected to 5 V through 5.1 k Ω		0.18		

electrical characteristics, $V_{CC} = 3\text{ V}$, $T_A = 25^\circ\text{C}$

PARAMETER	TEST CONDITIONS	TLV1393Y			UNIT
		MIN	TYP	MAX	
V_{IO} Input offset voltage	$V_O = 1.4\text{ V}$, $V_{IC} = V_{ICRmin}$		1.5	5	mV
V_{ICR} Common-mode input voltage range		0 to $V_{CC} - 1.5$	0 to $V_{CC} - 1.2$		V
I_{IO} Input offset current	$V_O = 1.4\text{ V}$		5	50	nA
I_{IB} Input bias current	$V_O = 1.4\text{ V}$		-40	-250	nA
I_{OH} High-level output current	$V_{ID} = 1\text{ V}$, $V_{OH} = 3\text{ V}$		0.1		nA
I_{OL} Low-level output current	$V_{ID} = -1\text{ V}$, $V_{OL} = 1.5\text{ V}$	500			μA
I_{CCH} High-level supply current	$V_O = V_{OH}$		160	250	μA
I_{CCL} Low-level supply current	$V_O = V_{OL}$		160	250	

switching characteristics, $V_{CC} = 3\text{ V}$, $C_L = 15\text{ pF}$, $T_A = 25^\circ\text{C}$

PARAMETER	TEST CONDITIONS	TLV1393Y			UNIT
		MIN	TYP	MAX	
Response time	100-mV input step with 5-mV overdrive, R_L connected to 5 V through 5.1 k Ω		0.7		μs



TLV1393, TLV1393Y, TLV2393, TLV2393Y DUAL DIFFERENTIAL COMPARATORS

SLCS121A – AUGUST 1993 – REVISED APRIL 1994

electrical characteristics, $V_{CC} = 5\text{ V}$, $T_A = 25^\circ\text{C}$

PARAMETER	TEST CONDITIONS	TLV1393Y			UNIT
		MIN	TYP	MAX	
V_{IO} Input offset voltage	$V_O = 1.4\text{ V}$, $V_{IC} = V_{ICRmin}$		1.5	5	mV
V_{ICR} Common-mode input voltage range		0 to $V_{CC} - 1.5$	0 to $V_{CC} - 1.2$		V
I_{IO} Input offset current	$V_O = 1.4\text{ V}$		5	50	nA
I_{IB} Input bias current	$V_O = 1.4\text{ V}$		-40	-250	nA
I_{OH} High-level output current	$V_{ID} = 1\text{ V}$, $V_{OH} = 3\text{ V}$		0.1		nA
I_{OL} Low-level output current	$V_{ID} = -1\text{ V}$, $V_{OL} = 1.5\text{ V}$	600			μA
I_{CCH} High-level supply current	$V_O = V_{OH}$		200	300	μA
I_{CCL} Low-level supply current	$V_O = V_{OL}$		200	300	

switching characteristics, $V_{CC} = 5\text{ V}$, $C_L = 15\text{ pF}$, $T_A = 25^\circ\text{C}$

PARAMETER	TEST CONDITIONS	TLV1393Y			UNIT
		MIN	TYP	MAX	
Response time	100-mV input step with 5-mV overdrive, R_L connected to 5 V through 5.1 k Ω		0.65		μs
	TTL-level input step, R_L connected to 5 V through 5.1 k Ω		0.18		

TLV1393, TLV1393Y, TLV2393, TLV2393Y DUAL DIFFERENTIAL COMPARATORS

SLCS121A – AUGUST 1993 – REVISED APRIL 1994

electrical characteristics, $V_{CC} = 3\text{ V}$

PARAMETER	TEST CONDITIONS	T_A †	TLV2393			UNIT
			MIN	TYP	MAX	
V_{IO} Input offset voltage	$V_O = 1.4\text{ V}$, $V_{IC} = V_{ICRmin}$	25°C		1.5	5	mV
		Full range			9	
V_{ICR} Common-mode input voltage range		25°C	0 to $V_{CC} - 1.5$	0 to $V_{CC} - 1.2$		V
		Full range	0 to $V_{CC} - 2$			
V_{OL} Low-level output voltage	$V_{ID} = -1\text{ V}$, $I_{OL} = 1\text{ mA}$	25°C		80	300	mV
	$V_{ID} = -1\text{ V}$, $I_{OL} = 4\text{ mA}$	Full range		250	700	
I_{IO} Input offset current	$V_O = 1.4\text{ V}$	25°C		5	50	nA
		Full range			150	
I_{IB} Input bias current	$V_O = 1.4\text{ V}$	25°C		-100	-250	nA
		Full range			-400	
I_{OH} High-level output current	$V_{ID} = 1\text{ V}$, $V_{OH} = 3\text{ V}$	25°C		0.1		nA
	$V_{ID} = 1\text{ V}$, $V_{OH} = 5\text{ V}$	Full range			100	
I_{OL} Low-level output current	$V_{ID} = -1\text{ V}$, $V_{OL} = 1.5\text{ V}$	25°C		4		mA
I_{CCH} High-level supply current	$V_O = V_{OH}$	25°C		450	600	μA
		Full range			700	
I_{CCL} Low-level supply current	$V_O = V_{OL}$	25°C		1.1	1.3	mA
		Full range			1.4	

† Full range is -40°C to 105°C .

switching characteristics, $V_{CC} = 3\text{ V}$, $C_L = 15\text{ pF}$, $T_A = 25^\circ\text{C}$

PARAMETER	TEST CONDITIONS	TLV2393			UNIT
		MIN	TYP	MAX	
Response time	100-mV input step with 5-mV overdrive, R_L connected to 5 V through 5.1 k Ω		0.45	1	μs



TLV1393, TLV1393Y, TLV2393, TLV2393Y DUAL DIFFERENTIAL COMPARATORS

SLCS121A – AUGUST 1993 – REVISED APRIL 1994

electrical characteristics, $V_{CC} = 5\text{ V}$

PARAMETER	TEST CONDITIONS	T_A †	TLV2393			UNIT
			MIN	TYP	MAX	
V_{IO} Input offset voltage	$V_O = 1.4\text{ V}$, $V_{IC} = V_{ICRmin}$	25°C		1.5	5	mV
		Full range			9	
V_{ICR} Common-mode input voltage range		25°C	0 to $V_{CC} - 1.5$	0 to $V_{CC} - 1.2$		V
		Full range	0 to $V_{CC} - 2$			
V_{OL} Low-level output voltage	$V_{ID} = -1\text{ V}$, $I_{OL} = 1\text{ mA}$	25°C		70	300	mV
	$V_{ID} = -1\text{ V}$, $I_{OL} = 4\text{ mA}$	Full range		200	700	
I_{IO} Input offset current	$V_O = 1.4\text{ V}$	25°C		5	50	nA
		Full range			150	
I_{IB} Input bias current	$V_O = 1.4\text{ V}$	25°C		-100	-250	nA
		Full range			-400	
I_{OH} High-level output current	$V_{ID} = 1\text{ V}$, $V_{OH} = 3\text{ V}$	25°C		0.1		nA
	$V_{ID} = 1\text{ V}$, $V_{OH} = 5\text{ V}$	Full range			100	
I_{OL} Low-level output current	$V_{ID} = -1\text{ V}$, $V_{OL} = 1.5\text{ V}$	25°C	6			mA
I_{CCH} High-level supply current	$V_O = V_{OH}$	25°C		550	700	μA
		Full range			800	
I_{CCL} Low-level supply current	$V_O = V_{OL}$	25°C		1.2	1.5	mA
		Full range			1.6	

† Full range is -40°C to 105°C .

switching characteristics, $V_{CC} = 5\text{ V}$, $C_L = 15\text{ pF}$, $T_A = 25^\circ\text{C}$

PARAMETER	TEST CONDITIONS	TLV2393			UNIT
		MIN	TYP	MAX	
Response time	100-mV input step with 5-mV overdrive, R_L connected to 5 V through 5.1 k Ω		0.4	0.8	μs
	TTL-level input step, R_L connected to 5 V through 5.1 k Ω		0.15	0.3	

TLV1393, TLV1393Y, TLV2393, TLV2393Y DUAL DIFFERENTIAL COMPARATORS

SLCS121A – AUGUST 1993 – REVISED APRIL 1994

electrical characteristics, $V_{CC} = 3\text{ V}$, $T_A = 25^\circ\text{C}$

PARAMETER	TEST CONDITIONS	TLV2393Y			UNIT
		MIN	TYP	MAX	
V_{IO} Input offset voltage	$V_O = 1.4\text{ V}$, $V_{IC} = V_{ICRmin}$		1.5	5	mV
V_{ICR} Common-mode input voltage range		0 to $V_{CC} - 1.5$	0 to $V_{CC} - 1.2$		V
V_{OL} Low-level output voltage	$V_{ID} = -1\text{ V}$, $I_{OL} = 1\text{ mA}$		80	300	mV
I_{IO} Input offset current	$V_O = 1.4\text{ V}$		5	50	nA
I_{IB} Input bias current	$V_O = 1.4\text{ V}$		-100	-250	nA
I_{OH} High-level output current	$V_{ID} = 1\text{ V}$, $V_{OH} = 3\text{ V}$		0.1		nA
I_{OL} Low-level output current	$V_{ID} = -1\text{ V}$, $V_{OL} = 1.5\text{ V}$	4			mA
I_{CCH} High-level supply current	$V_O = V_{OH}$		450	600	μA
I_{CCL} Low-level supply current	$V_O = V_{OL}$		1.1	1.3	mA

switching characteristics, $V_{CC} = 3\text{ V}$, $C_L = 15\text{ pF}$, $T_A = 25^\circ\text{C}$

PARAMETER	TEST CONDITIONS	TLV2393Y			UNIT
		MIN	TYP	MAX	
Response time	100-mV input step with 5-mV overdrive, R_L connected to 5 V through 5.1 k Ω		0.45	1	μs

electrical characteristics, $V_{CC} = 5\text{ V}$, $T_A = 25^\circ\text{C}$

PARAMETER	TEST CONDITIONS	TLV2393Y			UNIT
		MIN	TYP	MAX	
V_{IO} Input offset voltage	$V_O = 1.4\text{ V}$, $V_{IC} = V_{ICRmin}$		1.5	5	mV
V_{ICR} Common-mode input voltage range		0 to $V_{CC} - 1.5$	0 to $V_{CC} - 1.2$		V
V_{OL} Low-level output voltage	$V_{ID} = -1\text{ V}$, $I_{OL} = 1\text{ mA}$		70	300	mV
I_{IO} Input offset current	$V_O = 1.4\text{ V}$		5	50	nA
I_{IB} Input bias current	$V_O = 1.4\text{ V}$		-100	-250	nA
I_{OH} High-level output current	$V_{ID} = 1\text{ V}$, $V_{OH} = 3\text{ V}$		0.1		nA
I_{OL} Low-level output current	$V_{ID} = -1\text{ V}$, $V_{OL} = 1.5\text{ V}$	6			mA
I_{CCH} High-level supply current	$V_O = V_{OH}$		550	700	μA
I_{CCL} Low-level supply current	$V_O = V_{OL}$		1.2	1.5	mA

switching characteristics, $V_{CC} = 5\text{ V}$, $C_L = 15\text{ pF}$, $T_A = 25^\circ\text{C}$

PARAMETER	TEST CONDITIONS	TLV2393Y			UNIT
		MIN	TYP	MAX	
Response time	100-mV input step with 5-mV overdrive, R_L connected to 5 V through 5.1 k Ω		0.4	0.8	μs
	TTL-level input step, R_L connected to 5 V through 5.1 k Ω		0.15	0.3	



TYPICAL CHARACTERISTICS

Table of Graphs

		FIGURE
Input overdrives for TLV1393	vs Low-to-high-level output response time	1, 3
	vs High-to-low-level output response time	2, 4
Input overdrives for TLV2393	vs Low-to-high-level output response time	5, 7
	vs High-to-low-level output response time	6, 8

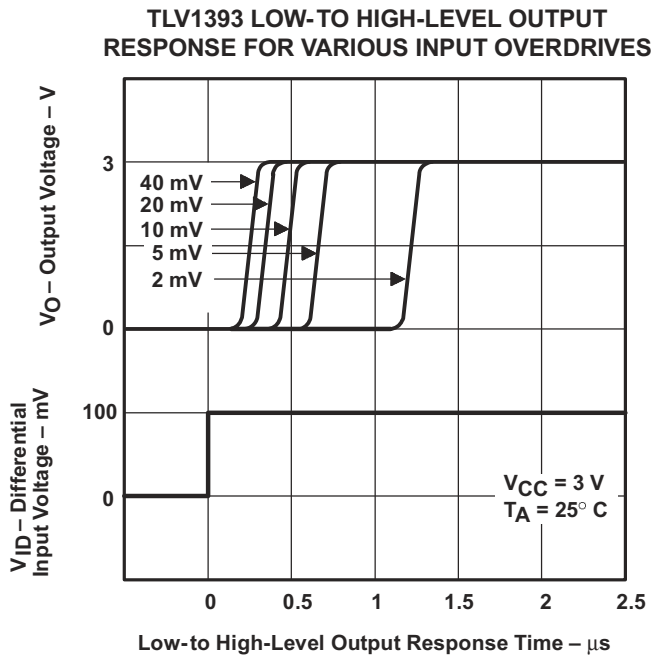

Figure 1

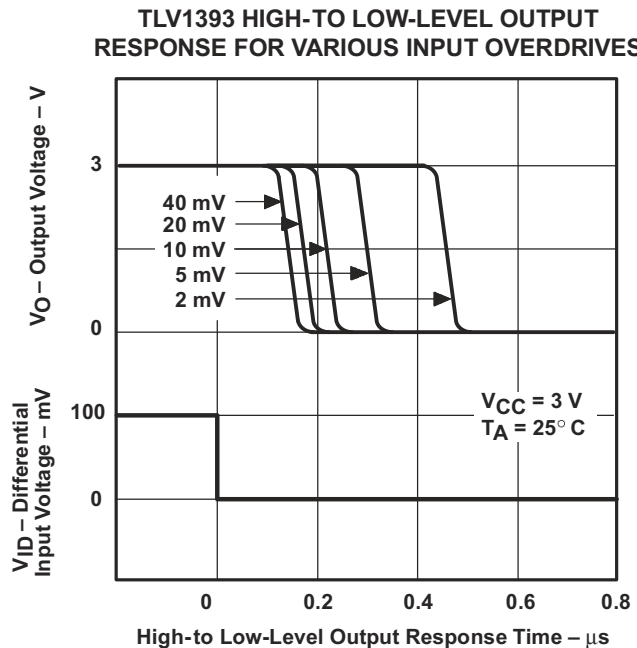

Figure 2

TLV1393, TLV1393Y, TLV2393, TLV2393Y DUAL DIFFERENTIAL COMPARATORS

SLCS121A – AUGUST 1993 – REVISED APRIL 1994

TYPICAL CHARACTERISTICS

TLV1393 LOW-TO-HIGH-LEVEL OUTPUT
RESPONSE FOR VARIOUS INPUT OVERDRIVES

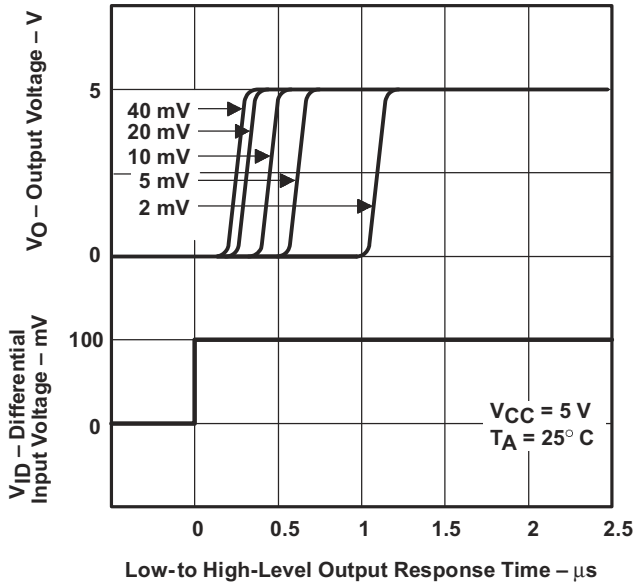

Figure 3

TLV1393 HIGH-TO-LOW-LEVEL OUTPUT
RESPONSE FOR VARIOUS INPUT OVERDRIVES

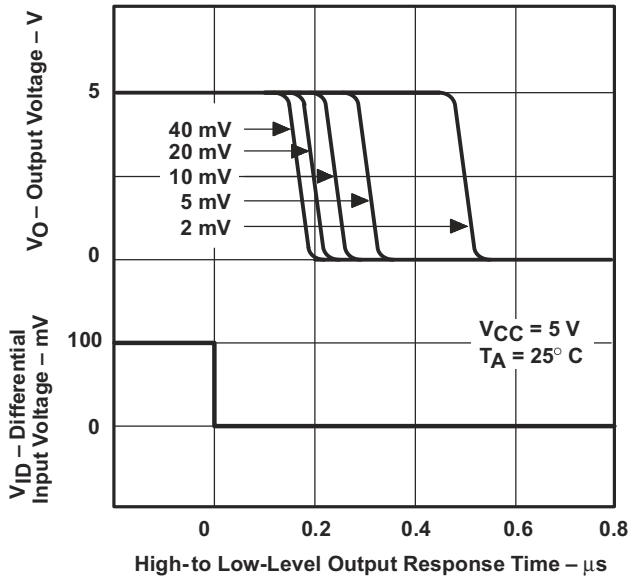

Figure 4

TLV2393 LOW-TO-HIGH-LEVEL OUTPUT
RESPONSE FOR VARIOUS INPUT OVERDRIVES

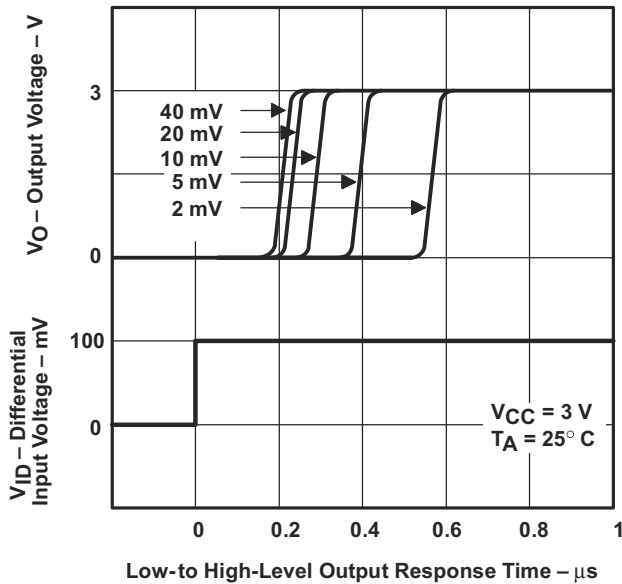

Figure 5

TLV2393 HIGH-TO-LOW-LEVEL OUTPUT
RESPONSE FOR VARIOUS INPUT OVERDRIVES

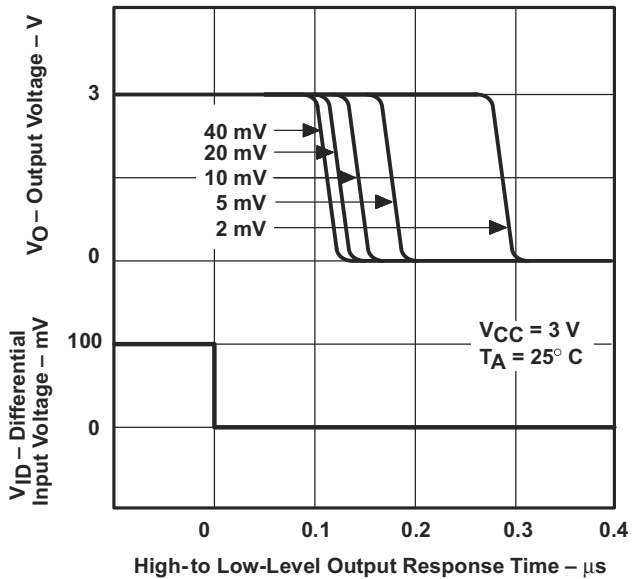

Figure 6

TYPICAL CHARACTERISTICS

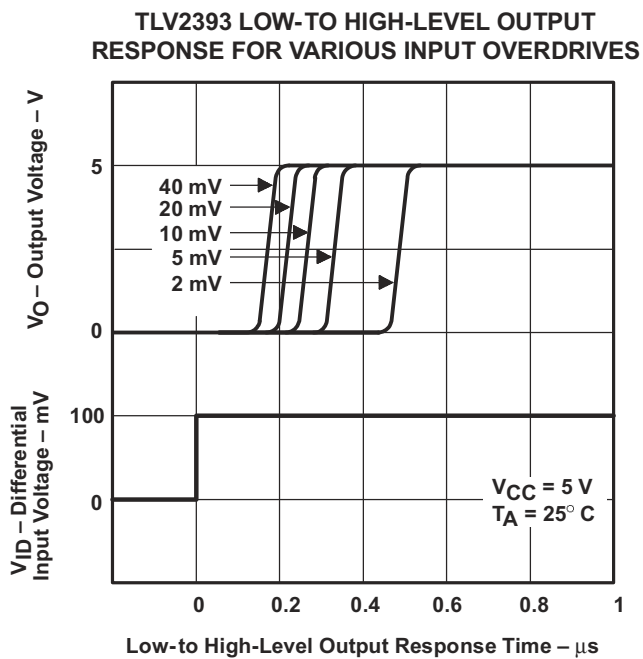

Figure 7

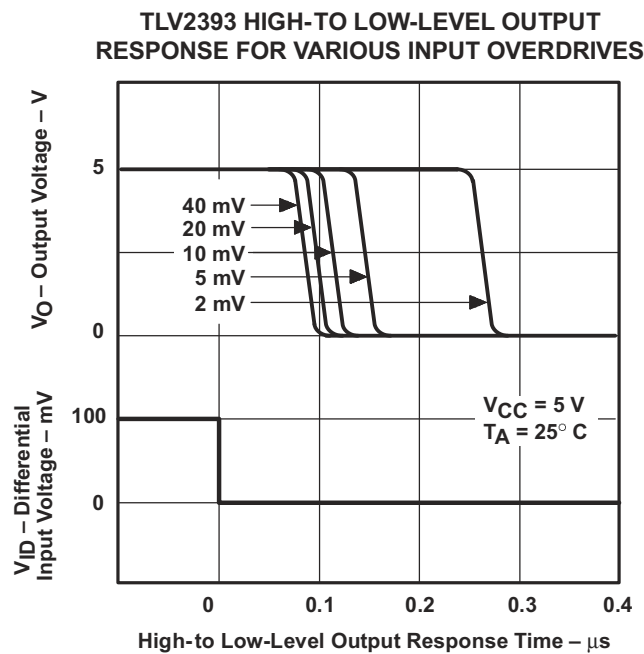

Figure 8

IMPORTANT NOTICE

Texas Instruments and its subsidiaries (TI) reserve the right to make changes to their products or to discontinue any product or service without notice, and advise customers to obtain the latest version of relevant information to verify, before placing orders, that information being relied on is current and complete. All products are sold subject to the terms and conditions of sale supplied at the time of order acknowledgement, including those pertaining to warranty, patent infringement, and limitation of liability.

TI warrants performance of its semiconductor products to the specifications applicable at the time of sale in accordance with TI's standard warranty. Testing and other quality control techniques are utilized to the extent TI deems necessary to support this warranty. Specific testing of all parameters of each device is not necessarily performed, except those mandated by government requirements.

CERTAIN APPLICATIONS USING SEMICONDUCTOR PRODUCTS MAY INVOLVE POTENTIAL RISKS OF DEATH, PERSONAL INJURY, OR SEVERE PROPERTY OR ENVIRONMENTAL DAMAGE ("CRITICAL APPLICATIONS"). TI SEMICONDUCTOR PRODUCTS ARE NOT DESIGNED, AUTHORIZED, OR WARRANTED TO BE SUITABLE FOR USE IN LIFE-SUPPORT DEVICES OR SYSTEMS OR OTHER CRITICAL APPLICATIONS. INCLUSION OF TI PRODUCTS IN SUCH APPLICATIONS IS UNDERSTOOD TO BE FULLY AT THE CUSTOMER'S RISK.

In order to minimize risks associated with the customer's applications, adequate design and operating safeguards must be provided by the customer to minimize inherent or procedural hazards.

TI assumes no liability for applications assistance or customer product design. TI does not warrant or represent that any license, either express or implied, is granted under any patent right, copyright, mask work right, or other intellectual property right of TI covering or relating to any combination, machine, or process in which such semiconductor products or services might be or are used. TI's publication of information regarding any third party's products or services does not constitute TI's approval, warranty or endorsement thereof.